



Cambridge IGCSE™ (9–1)

CANDIDATE
NAME

CENTRE
NUMBER

--	--	--	--	--

CANDIDATE
NUMBER

--	--	--	--



BIOLOGY

0970/32

Paper 3 Theory (Core)

October/November 2021

1 hour 15 minutes

You must answer on the question paper.

No additional materials are needed.

INSTRUCTIONS

- Answer **all** questions.
- Use a black or dark blue pen. You may use an HB pencil for any diagrams or graphs.
- Write your name, centre number and candidate number in the boxes at the top of the page.
- Write your answer to each question in the space provided.
- Do **not** use an erasable pen or correction fluid.
- Do **not** write on any bar codes.
- You may use a calculator.
- You should show all your working and use appropriate units.

INFORMATION

- The total mark for this paper is 80.
- The number of marks for each question or part question is shown in brackets [].

This document has **20** pages. Any blank pages are indicated.

- 1 (a) Fig. 1.1 is a diagram of the parts of the eye.

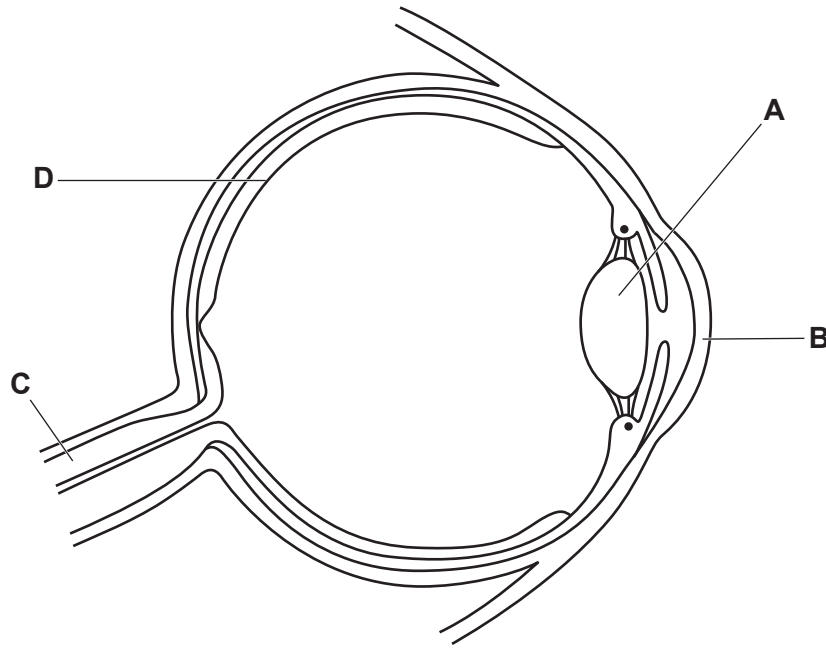

Fig. 1.1

- (i) The boxes on the left show the letters of the parts of the eye in Fig. 1.1.

The boxes on the right show some functions of parts of the eye.

Draw lines to link the letter of the part from Fig. 1.1 to its function.

letter in Fig. 1.1

A

B

C

D

function

carries impulses to the brain

contains light receptors

focusses light onto the retina

refracts light as it enters the eye

[3]

- (ii) Draw an X on Fig. 1.1 to show the position of the blind spot.

[1]

(b) Fig. 1.2 shows the change that occurs in the eye after it is exposed to bright light.

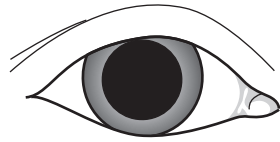

before exposure

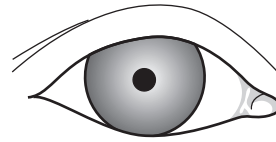

after exposure

Fig. 1.2

Describe the change to the eye in Fig. 1.2 **and** explain why this change is important.

.....

.....

.....

.....

.....

.....

.....

..... [3]

(c) The eye is a sense organ.

The skin is another type of sense organ.

State **two** stimuli that skin responds to.

1

2

[2]

[Total: 9]

- 2 (a) Table 2.1 shows the breathing rate of different organisms.

Table 2.1

name of organism	breathing rate / average number of breaths per minute
buffalo	17
camel	8
cat	20
chicken	18
elephant	12
goat	21
horse	10
human	16
sheep	20

- (i) State the name of the organism with the lowest breathing rate.

..... [1]

- (ii) State the name of **two** organisms with the same breathing rate.

..... and [1]

- (iii) State the name of the organism with the most **similar** breathing rate to humans.

..... [1]

- (b) A person goes from resting to exercising.

Describe how their breathing changes.

.....

 [2]

(c) There is more carbon dioxide in expired air than in inspired air.

(i) State **two other** ways the composition of expired air is different from inspired air.

1

.....

2

.....

[2]

(ii) State the chemical used to test for the presence of carbon dioxide gas and the positive test result.

chemical

positive test result

[2]

(d) Fig. 2.1 is a diagram of the human gas exchange system.

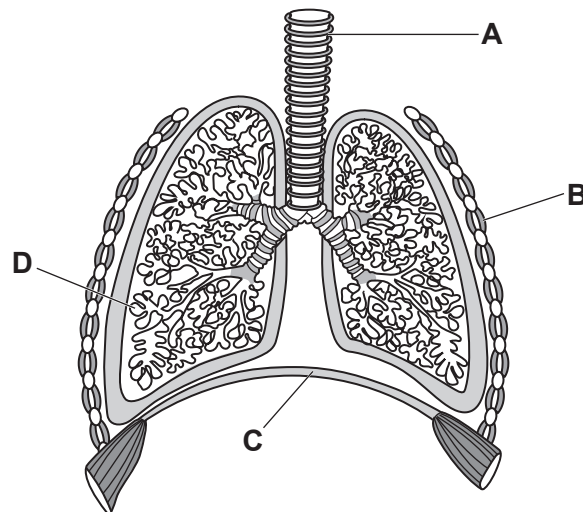

Fig. 2.1

Identify the parts labelled **A**, **B**, **C** and **D** in Fig. 2.1.

A

B

C

D

[4]

[Total: 13]

- 3 (a) A species of pea plant can produce green or yellow peas.

Fig. 3.1 shows a photograph of a green pea and a yellow pea.

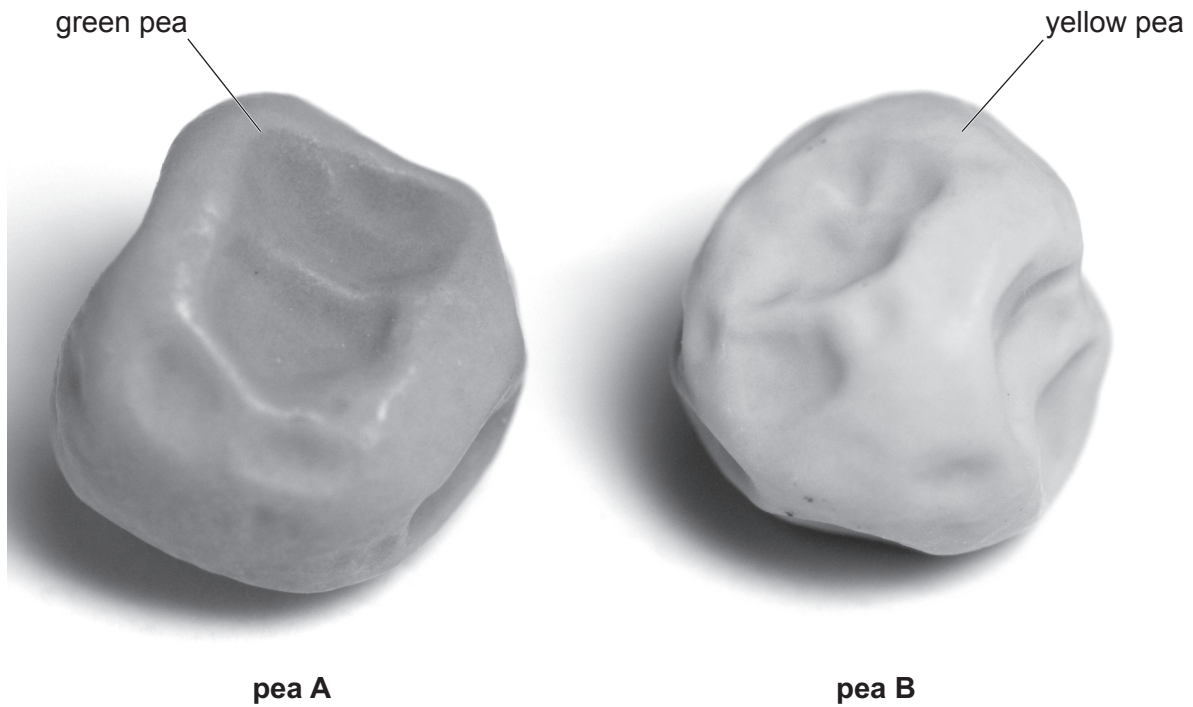

Fig. 3.1

The colour of peas is controlled by a single gene:

- The allele for yellow peas is dominant and is represented by the letter **G**.
- The allele for green peas is recessive and is represented by the letter **g**.

- (i) Use your knowledge and this information to complete Table 3.1.

Table 3.1

genotype of pea A	
phenotype of pea B	
phenotype of a pea with a heterozygous genotype	

[3]

(ii) Two pea plants were crossed.

Complete the genetic diagram in Fig. 3.2 to show the outcome of the cross.

		parental gametes	
		g	g
parental gametes	G
	g

ratio of yellow offspring : green offspring :

[2]

Fig. 3.2

(b) Cystic fibrosis is a disease caused by a recessive allele in humans.

Fig. 3.3 is a pedigree diagram showing the inheritance of cystic fibrosis in a family.

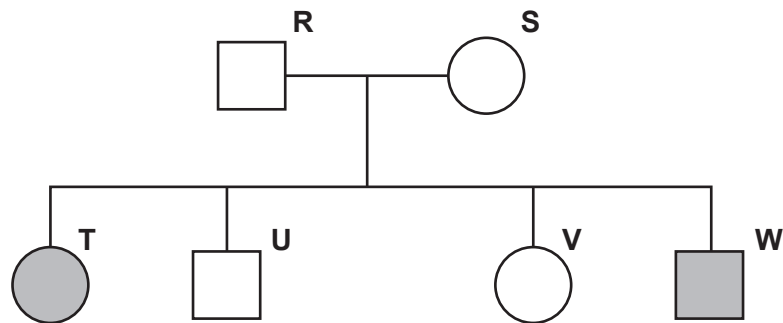

Key:

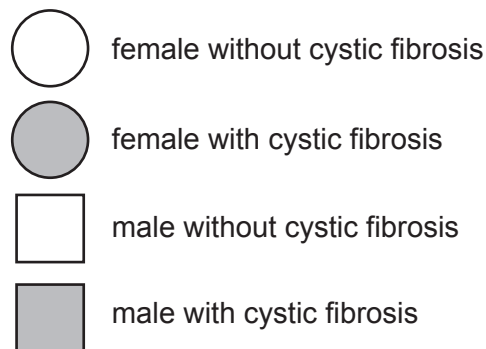

Fig. 3.3

(i) State the number of people that have cystic fibrosis.

..... [1]

(ii) Identify the letter of a person that **must** have a heterozygous genotype.

..... [1]

(iii) Person **U** has a homozygous dominant genotype.

Circle the probability of person **U** having a child with cystic fibrosis.

0% **25%** **50%** **75%** **100%** [1]

[Total: 8]

BLANK PAGE

- 4 (a) It is important for humans to consume a balanced diet.

Describe what is meant by the term balanced diet.

.....

.....

.....

.....

..... [2]

- (b) Table 4.1 shows some of the different components of a balanced diet and their principal sources.

Complete Table 4.1 using words from the list.

Each word can only be used **once** or not at all.

grapefruit milk olive oil rice tuna fish water

Table 4.1

component	example of principal source
calcium	
carbohydrate	
protein	
vitamin C	

[4]

- (c) A diet that does not contain component **X** can cause constipation.

State the name of component **X**.

..... [1]

(d) A person's diet contains too much energy and too much fat.

Describe the possible risks of this diet.

.....
.....
.....
.....
..... [2]

(e) State why a pregnant woman needs to eat more food than a woman who is not pregnant.

.....
.....
..... [1]

(f) Nutrition is one of the characteristics of living things.

State the names of **three other** characteristics of living things.

1
2
3 [3]

[Total: 13]

- 5 (a) Define the term *transpiration* by completing the sentences.

Transpiration is the loss of water vapour from plant leaves by
 of water at the surfaces of the mesophyll cells followed by of
 water vapour through the

[3]

- (b) A student investigated the volume of water lost in one hour by different species of plants at different temperatures.

Fig. 5.1 shows the results.

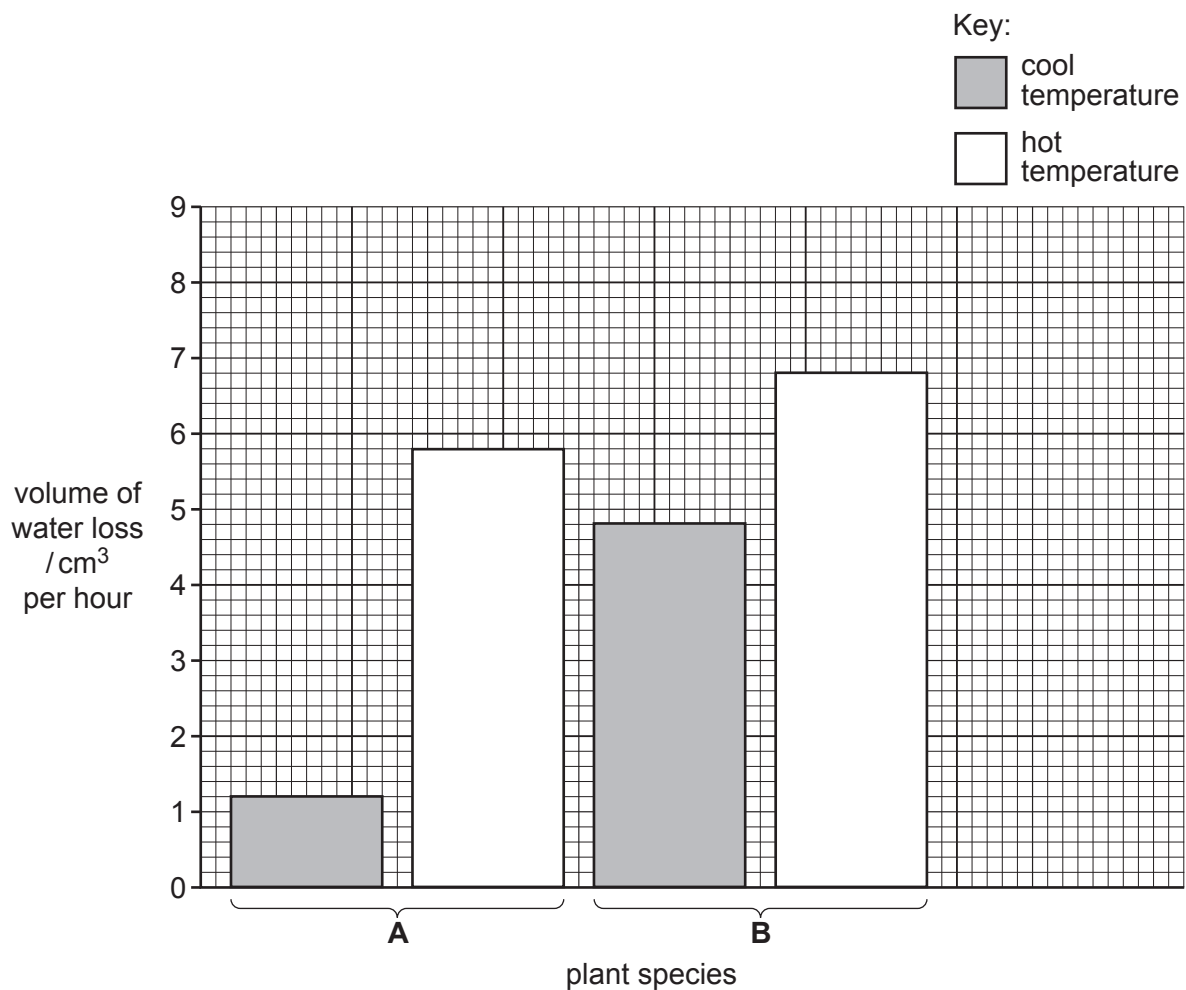

Fig. 5.1

Compare the volume of water loss in species **A** and species **B**.

.....

.....

.....

.....

.....

.....

.....

.....

..... [3]

(c) The investigation was repeated with increased humidity.

The temperature was cool.

Draw **one** additional bar **on Fig. 5.1**, for species **B** only, to show the expected result. [1]

(d) State the name of the vessels that transport water through a plant.

..... [1]

[Total: 8]

- 6 (a) Fig. 6.1 shows the changes that happen to the thickness of the uterus lining during the menstrual cycle.

The loss of the lining of the uterus is called menstruation.

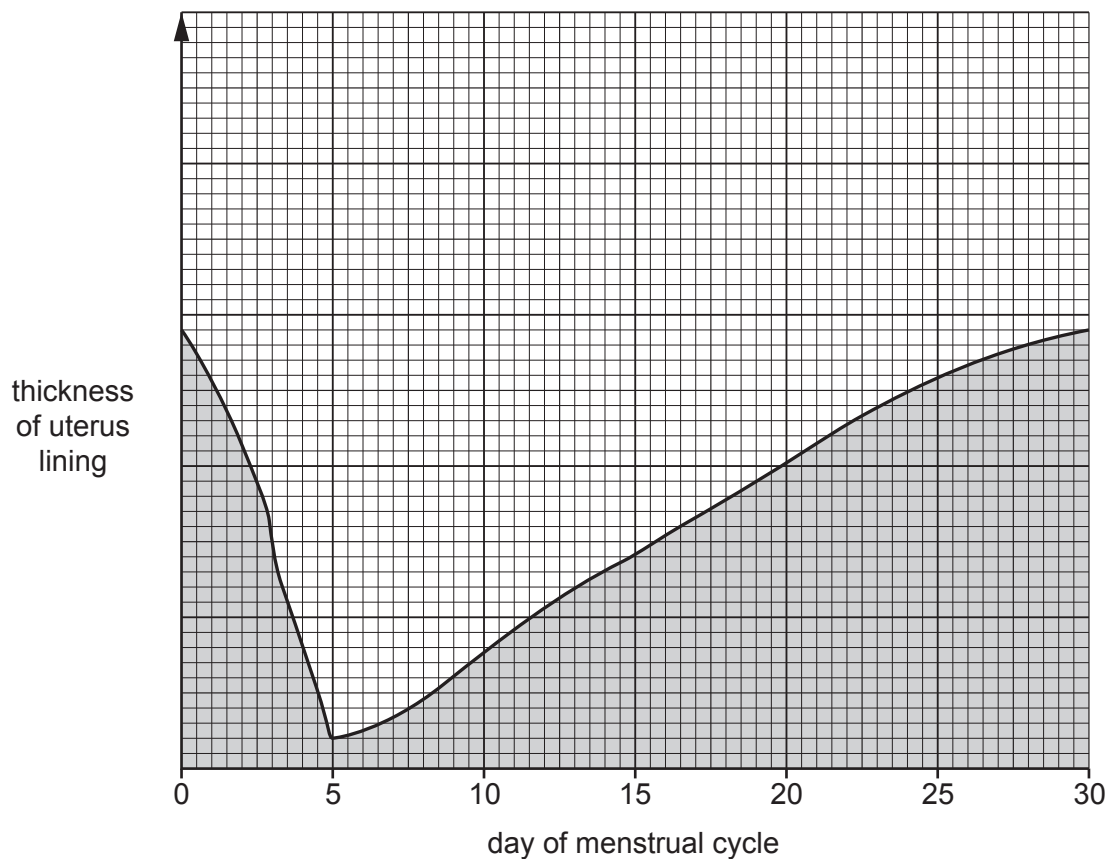

Fig. 6.1

Use Fig. 6.1 and the numbers from the list to answer these questions.

Each number can be used once, more than once or not at all.

0 5 8 15 28 30

State the number of days of this menstrual cycle.

State the number of days that menstruation lasts.

State the day on which ovulation is most likely to occur.

State **one** day when the uterus lining is at its thickest.

[4]

- (b) Table 6.1 shows some of the changes that happen to boys and girls during puberty.

Place ticks (✓) in Table 6.1 to show which changes happen in boys and which changes happen in girls.

Table 6.1

	boys	girls
breasts grow		
growth of pubic hair		
widening of hips		

[3]

- (c) State the name of the hormone that causes the development of secondary sexual characteristics in girls.

..... [1]

- (d) State where the hormone that causes the development of secondary sexual characteristics in boys is produced.

..... [1]

[Total: 9]

- 7 (a) A student investigated the effect of different concentrations of pectinase on the volume of apple juice produced.

1 cm³ of pectinase solution was added to 5 g of mashed apples and the volume of apple juice produced was recorded. Six different concentrations of pectinase solution were tested.

The results are shown in Table 7.1.

Table 7.1

percentage concentration of pectinase solution	volume of apple juice produced / cm ³
0	4.4
5	5.0
10	5.4
15	5.8
20	
25	7.4

- (i) Predict the volume of apple juice produced using pectinase solution with a concentration of 20%.

..... cm³ [1]

- (ii) Calculate the percentage increase in the volume of apple juice produced when the concentration of pectinase solution increased from 0% to 10%.

Space for working.

.....%
[2]

- (b) Crops such as apples can be selectively bred.

The box on the left contains a sentence beginning.

The boxes on the right contain some sentence endings.

Draw **two** lines to make two correct sentences about selective breeding.

Selective breeding

involves one parent only.

is carried out over many generations.

is caused by mutation.

is caused by the environment.

requires human involvement.

[2]

- (c) Some of the statements shown correctly describe events that happen during the process of natural selection.

Two of the statements are incorrect.

1	There is no variation within populations.
2	Many offspring are produced so there is more competition for resources.
3	Individuals that are not suited to the environment die.
4	Individuals that are better suited to the environment survive and breed.
5	Offspring pass their alleles to their parents.

State the numbers of the **two** incorrect statements.

..... and

[2]

- (d) State the term that is defined as an inherited feature that helps an organism to survive and reproduce in its environment.

..... [1]

[Total: 8]

- 8 (a) Define the term population by completing the sentence.

A population is a group of organisms of one, living in the same, at the same [3]

- (b) The human population size of one country was monitored between 1950 and 2010.

Fig. 8.1 shows the results.

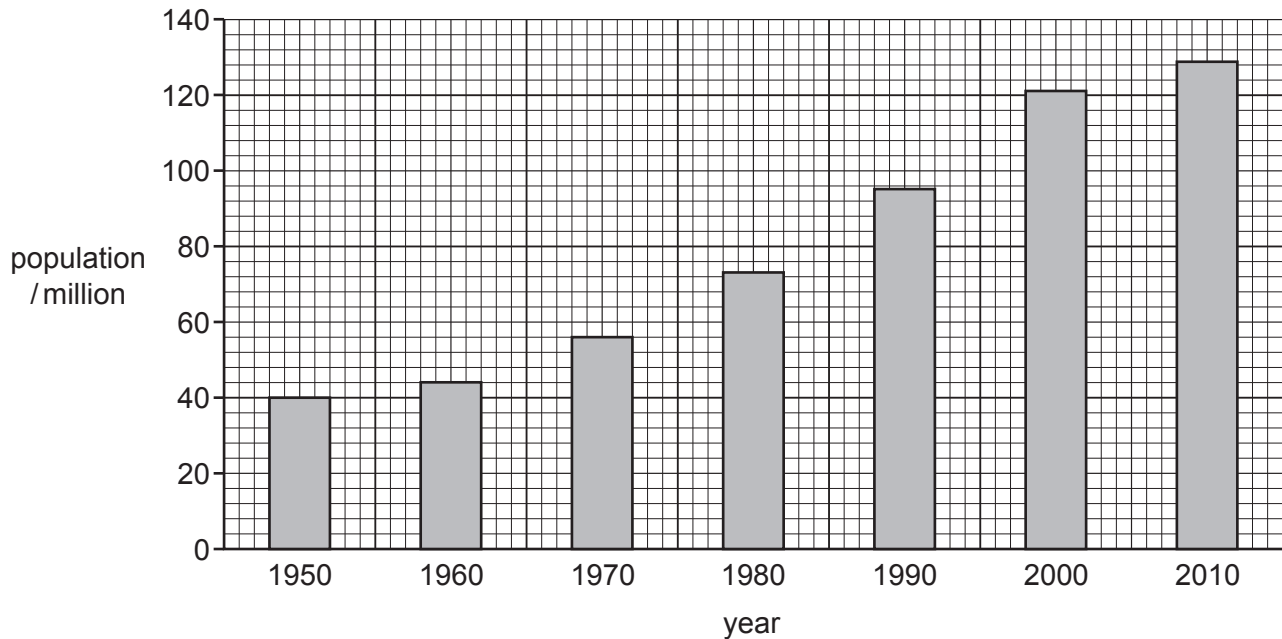

Fig. 8.1

- (i) Calculate the difference in population size between 1950 and 2010.

..... million [1]

- (ii) State the year when the population size was 56 million.

..... [1]

- (c) State **three** factors that can cause an increase in population size.

1

2

3

[3]

BLANK PAGE

Permission to reproduce items where third-party owned material protected by copyright is included has been sought and cleared where possible. Every reasonable effort has been made by the publisher (UCLES) to trace copyright holders, but if any items requiring clearance have unwittingly been included, the publisher will be pleased to make amends at the earliest possible opportunity.

To avoid the issue of disclosure of answer-related information to candidates, all copyright acknowledgements are reproduced online in the Cambridge Assessment International Education Copyright Acknowledgements Booklet. This is produced for each series of examinations and is freely available to download at www.cambridgeinternational.org after the live examination series.

Cambridge Assessment International Education is part of the Cambridge Assessment Group. Cambridge Assessment is the brand name of the University of Cambridge Local Examinations Syndicate (UCLES), which itself is a department of the University of Cambridge.