



Cambridge
IGCSE

Cambridge International Examinations
Cambridge International General Certificate of Secondary Education

CHEMISTRY (US)

0439/13

Paper 1 Multiple Choice

May/June 2015

45 Minutes

Additional Materials: Multiple Choice Answer Sheet
 Soft clean eraser
 Soft pencil (type B or HB is recommended)

* 5 6 2 8 4 1 7 9 6 1 *



READ THESE INSTRUCTIONS FIRST

Write in soft pencil.

Do not use staples, paper clips, glue or correction fluid.

Write your name, Center number and candidate number on the Answer Sheet in the spaces provided unless this has been done for you.

DO NOT WRITE IN ANY BARCODES.

There are **forty** questions on this paper. Answer **all** questions. For each question there are four possible answers **A, B, C** and **D**.

Choose the **one** you consider correct and record your choice in **soft pencil** on the separate Answer Sheet.

Read the instructions on the Answer Sheet very carefully.

Each correct answer will score one mark. A mark will not be deducted for a wrong answer.

Any rough working should be done in this booklet.

A copy of the Periodic Table is printed on page 16.

Electronic calculators may be used.

This document consists of **14** printed pages and **2** blank pages.

2

- 1 A sugar cube is dropped into a hot cup of tea.

The tea is not stirred.

Which statement explains why the tea becomes sweet?

- A The heated water molecules penetrate the sugar cube.
- B The hot tea causes the sugar to melt.
- C The sugar cube dissolves and its molecules diffuse.
- D The sugar molecules get hot and evaporate.

- 2 A blue solid, X, is soluble in water.

Which method is used to obtain pure solid X from an aqueous solution?

- A chromatography
- B crystallization
- C filtration
- D neutralization

- 3 Two atoms, X and Y, can be represented as shown.



Which statement is **not** correct?

- A X and Y are atoms of different elements.
 - B X and Y are isotopes.
 - C X and Y have different mass numbers.
 - D X and Y have the same number of electrons.
- 4 Two atoms have the same relative atomic mass but different chemical properties.

Which row about the proton and neutron numbers of these atoms is correct?

	proton numbers	neutron numbers
A	different	different
B	different	same
C	same	different
D	same	same

- 5 Which statements comparing the properties of electrons, neutrons and protons are correct?

	neutrons and protons are both heavier than electrons	only electrons and neutrons are charged
A	✓	✓
B	✓	✗
C	✗	✓
D	✗	✗

- 6 Diamond and graphite are both macromolecules.

Which statement is **not** correct?

- A** Diamond and graphite contain carbon atoms only.
B Diamond and graphite contain charged ions.
C Diamond and graphite have high melting points.
D The atoms in diamond and graphite are held together by covalent bonds.

- 7 In which compounds are pairs of electrons shared between atoms?

- 1 methane
2 lead bromide
3 sodium chloride

- A** 1 only **B** 2 only **C** 1 and 3 **D** 1, 2 and 3

- 8 Aluminum oxide has the formula Al_2O_3 .

Which statement about aluminum oxide is correct?

- A** 2 g of aluminum atoms are combined with 3 g of oxygen atoms.
B 2 g of aluminum atoms are combined with 3 g of oxygen molecules.
C Aluminum oxide has a relative molecular mass of 102.
D Pure aluminum oxide contains a higher mass of oxygen than of aluminum.

4

9 Copper and hydrogen can each be formed by electrolysis.

At which electrodes are these elements formed?

	copper	hydrogen
A	anode	anode
B	anode	cathode
C	cathode	anode
D	cathode	cathode

10 An object is electroplated with silver using an aqueous silver salt as the electrolyte.

Which set of conditions is used?

	the object to be electroplated is the	the other electrode is made from
A	anode	carbon
B	anode	silver
C	cathode	carbon
D	cathode	silver

11 Which substance does **not** use oxygen to produce energy?

- A** coal
- B** hydrogen
- C** natural gas
- D** uranium

12 In which change is N_2O_3 oxidized?

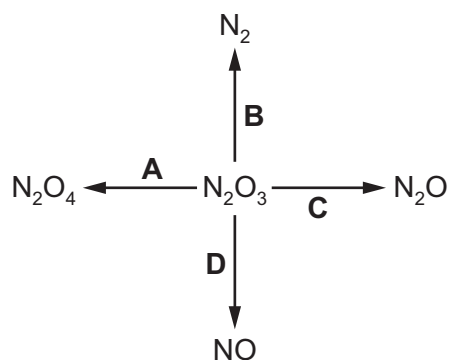

- 13 When pink crystals of cobalt(II) chloride are heated, steam is given off and the color changes to blue.

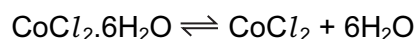

What happens when water is added to the blue solid?

	color	temperature
A	changes to pink	decreases
B	changes to pink	increases
C	remains blue	decreases
D	remains blue	increases

- 14 The diagram shows an experiment to measure the rate of a chemical reaction.

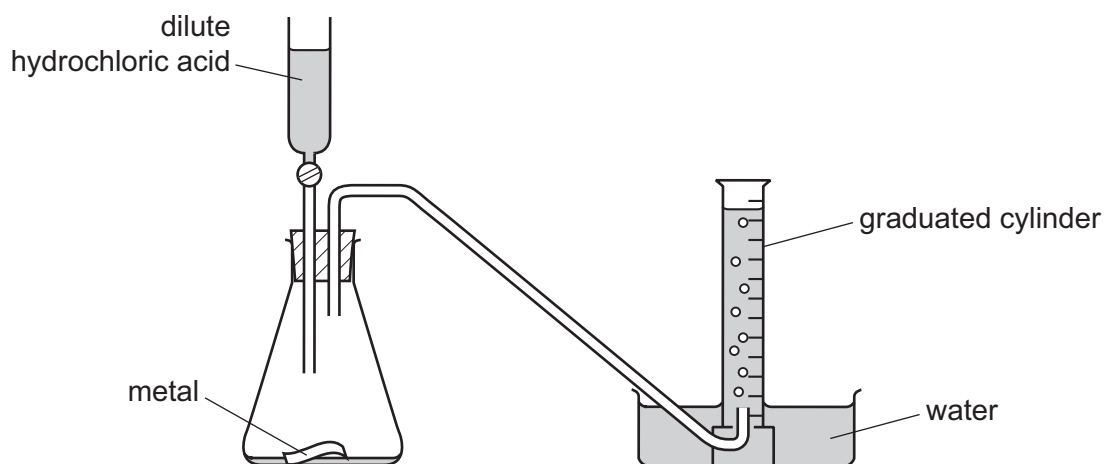

Which change decreases the rate of reaction?

- A** adding water to the flask
- B** heating the flask during the reaction
- C** using more concentrated acid
- D** using powdered metal
- 15 Which reaction is **not** characteristic of an acid?
- A** It dissolves magnesium oxide.
- B** It produces ammonia from ammonium compounds.
- C** It produces carbon dioxide from a carbonate.
- D** It produces hydrogen from zinc metal.

16 Hydrochloric acid is used to clean metals.

The acid reacts with the oxide layer on the surface of the metal, forming a salt and water.

Which word describes the metal oxide?

- A alloy
- B base
- C element
- D indicator

17 Which of the following methods are suitable for preparing both zinc sulfate and copper sulfate?

- 1 Reacting the metal oxide with warm dilute aqueous sulfuric acid.
- 2 Reacting the metal with dilute aqueous sulfuric acid.
- 3 Reacting the metal carbonate with dilute aqueous sulfuric acid.

- A 1 and 2 only
- B 1 and 3 only
- C 2 and 3 only
- D 1, 2 and 3

18 Which gas relights a glowing splint?

- A ammonia
- B carbon dioxide
- C hydrogen
- D oxygen

19 The noble gases, which are in Group 0 of the Periodic Table, are all very 1..... .

.....2....., one of these gases, is used to provide an inert atmosphere in lamps.

Another,3....., is used for filling balloons because it is less dense than air.

Which words complete the sentences about noble gases?

	1	2	3
A	reactive	argon	helium
B	reactive	helium	argon
C	unreactive	argon	helium
D	unreactive	helium	argon

23 The diagrams show the structure of two substances used to make electrical conductors.

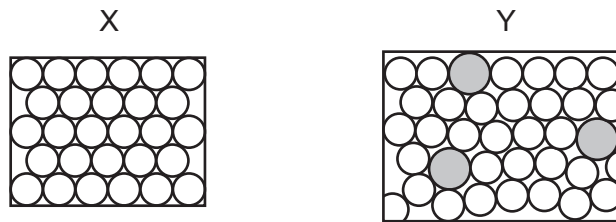

Which statement correctly describes X and Y?

- A** X is a pure metal and Y is a compound.
- B** X is a pure metal and Y is an alloy.
- C** X is a solid and Y is a liquid.
- D** X is harder and stronger than Y.
- 24 Which statement about the uses of aluminum, mild steel and stainless steel is correct?
- A** Aluminum is used for food containers as it has a high density.
- B** Mild steel is used for car bodies as it is resistant to corrosion.
- C** Stainless steel is used for aircraft bodies as it is strong.
- D** Stainless steel is used for cutlery as it is resistant to corrosion.
- 25 Which row describes the conditions used to make steel from the iron produced by a blast furnace?

	calcium oxide (lime)	oxygen	heat
A	✓	✓	✓
B	✓	✓	x
C	x	✓	✓
D	x	✓	x

26 The statements describe how different metals react with cold water.

- Calcium sinks, fizzing and releasing a steady stream of hydrogen.
- Copper does not react.
- Sodium floats, fizzing and rapidly releasing hydrogen.
- Zinc does not react but does react with steam, releasing hydrogen.

Using the information, where should hydrogen be placed in the reactivity series?

- A** below copper
B between sodium and calcium
C between calcium and zinc
D between zinc and copper

27 The diagram shows stages in producing drinking water.

In which tank is chlorine added to the water?

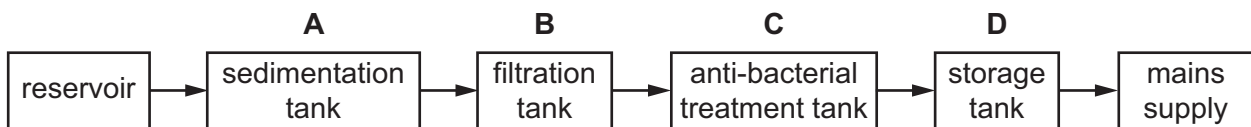

28 Oxygen is a reactive element.

Which row shows which of oxygen's reactions are useful?

	fuel combustion	rusting	steel manufacture
A	no	no	yes
B	no	yes	no
C	yes	no	yes
D	yes	yes	no

29 Which combination of chemical compounds could be used to produce the fertilizer shown?

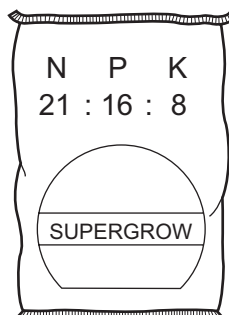

- A $(\text{NH}_4)_3\text{PO}_4$, KCl
- B NH_4NO_3 , $\text{Ca}_3(\text{PO}_4)_2$
- C NH_4NO_3 , $\text{CO}(\text{NH}_2)_2$
- D NH_4NO_3 , K_2SO_4 , $(\text{NH}_4)_2\text{SO}_4$

30 Below are two statements about sulfur dioxide.

- 1 Sulfur dioxide is formed when fossil fuels burn and it is an acidic oxide.
- 2 Sulfur dioxide is one of the gases in the air which is responsible for 'acid rain'.

Which is correct?

- A Both statements are correct and statement 1 explains statement 2.
- B Both statements are correct but statement 1 does not explain statement 2.
- C Statement 1 is correct but statement 2 is incorrect.
- D Statement 2 is correct but statement 1 is incorrect.

31 Which method is **not** used for rust prevention?

- A coating working parts of industrial machinery with oil
- B covering wire for gardening use with plastic
- C immersing gardening tools in water for storage
- D painting car bodies

32 Carbon dioxide and methane are 'greenhouse gases' which contribute to global warming.

Which process does **not** increase global warming?

- A burning fossil fuels
- B decay of organic waste
- C farming cattle for beef
- D growing crops such as sugar cane

33 Four reactions produce carbon dioxide.

- 1 respiration
- 2 fermentation
- 3 combustion of methane
- 4 manufacture of lime

Which reactions do **not** use oxygen from the air?

- A** 1 and 2 **B** 1 and 3 **C** 2 and 4 **D** 3 and 4

34 The diagram shows a kiln used to manufacture lime.

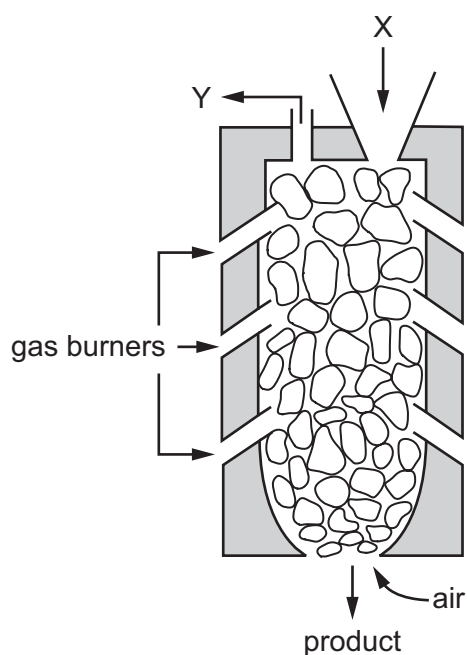

Which row identifies X and Y?

	X	Y
A	lime	carbon dioxide
B	lime	steam
C	limestone	carbon dioxide
D	limestone	steam

35 Which statement about the names of organic compounds is correct?

- A** Compounds containing C=C double bonds are alkanes.
- B** The compound of formula $\text{CH}_3\text{CO}_2\text{H}$ is methanoic acid.
- C** The compound of formula C_2H_4 is ethane.
- D** The compound of formula $\text{C}_2\text{H}_5\text{OH}$ is an alcohol.

36 Which statement about petroleum is **not** correct?

- A It can be separated into useful substances by fractional distillation.
- B It consists mainly of hydrocarbons.
- C It is found underground in many parts of the world.
- D Its main use is for making lubricants and polishes.

37 Ethene, propene and butene are all members of the same homologous series.

Which statement explains why ethene, propene and butene have similar chemical properties?

- A They all have the same functional group.
- B They are all gases at room temperature.
- C They are all hydrocarbons.
- D They are all organic.

38 Which statement describes the compound shown below?

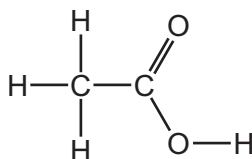

- A It is a colorless flammable gas.
- B It is a liquid which decolorizes bromine water.
- C It is a liquid with a characteristic smell.
- D It is formed when ethane reacts with steam.

39 A hydrocarbon A is cracked to make B and hydrogen.

Compound C is formed by the addition polymerization of B.

To which homologous series do A, B and C belong?

	alkene	alkane
A	A	B and C
B	B	A and C
C	C	A and B
D	–	A and C

40 Ethanol is manufactured from petroleum by reacting ethene with steam.

Which statements about this process are correct?

- 1 Ethene is obtained from the cracking of alkanes.
- 2 The process is carried out in the presence of yeast.
- 3 The reaction is an addition reaction.
- 4 The rate of reaction is increased by a catalyst.

A 1 and 3 only **B** 1 and 4 only **C** 1, 2 and 3 **D** 1, 3 and 4

DATA SHEET
The Periodic Table of the Elements

		Group																
		I	II	III	IV	V	VI	VII	VIII	IX	X							
		1 H Hydrogen 1																
7	9	Li Lithium 3	Be Beryllium 4											He Helium 2	4			
23	24	Na Sodium 11	Mg Magnesium 12											Ne Neon 10	20			
39	40	K Potassium 19	Ca Calcium 20	51 V Vanadium 23	48 Ti Titanium 22	45 Sc Scandium 21	56 Fe Iron 26	59 Co Cobalt 27	59 Ni Nickel 28	64 Cu Copper 29	65 Zn Zinc 30	70 Ga Gallium 31	73 Ge Germanium 32	75 As Arsenic 33	79 Se Selenium 34	80 Br Bromine 35	84 Kr Krypton 36	
85	88	Rb Rubidium 37	Sr Strontium 38	93 Nb Niobium 41	91 Zr Zirconium 40	89 Y Yttrium 39	101 Ru Ruthenium 44	103 Rh Rhodium 45	106 Pd Palladium 46	108 Ag Silver 47	112 Cd Cadmium 48	115 In Indium 49	119 Sn Tin 50	122 Sb Antimony 51	128 Te Tellurium 52	127 I Iodine 53	131 Xe Xenon 54	
133	137	Cs Caesium 55	Ba Barium 56	181 Ta Tantalum 73	178 Hf Hafnium 72	139 La Lanthanum 57	190 Os Osmium 76	192 Ir Iridium 77	195 Pt Platinum 78	197 Au Gold 79	201 Hg Mercury 80	204 Tl Thallium 81	207 Pb Lead 82	209 Bi Bismuth 83	210 Po Polonium 84	210 At Astatine 85	210 Rn Radon 86	
	226	Fr Francium 87	Ra Radium 88											Ac Actinium 89	†			
													*58-71 Lanthanoid series †90-103 Actinoid series					
		a		X		b		a = relative atomic mass X = atomic symbol b = proton (atomic) number		Key								
		140	141	144	150	152	157	159	162	165	167	169	173	175	175	175	175	175
		Ce Cerium 58	Pr Praseodymium 59	Nd Neodymium 60	Pm Promethium 61	Sm Samarium 62	Gd Gadolinium 64	Tb Terbium 65	Dy Dysprosium 66	Ho Holmium 67	Er Erbium 68	Tm Thulium 69	Yb Ytterbium 70	Lu Lutetium 71	Lu Lutetium 71	Lu Lutetium 71	Lu Lutetium 71	Lu Lutetium 71
		232	238	238	238	238	238	238	238	238	238	238	238	238	238	238	238	238
		Th Thorium 90	Pa Protactinium 91	U Uranium 92	Np Neptunium 93	Pu Plutonium 94	Am Americium 95	Cm Curium 96	Bk Berkelium 97	Cf Californium 98	Es Einsteinium 99	Fm Fermium 100	Md Mendelevium 101	No Nobelium 102	Lr Lawrencium 103	Lr Lawrencium 103	Lr Lawrencium 103	Lr Lawrencium 103

The volume of one mole of any gas is 24 dm³ at room temperature and pressure (r.t.p.).