

1 A school has 220 boys and 280 girls.

(a) Find the ratio of boys to girls, in its simplest form.

Answer(a) : [1]

(b) The ratio of students to teachers is 10 : 1.
Find the number of teachers.

Answer(b) [2]

(c) There are 21 students on the school's committee.
The ratio of boys to girls is 3 : 4.
Find the number of girls on the committee.

Answer(c) [2]

(d) The committee organises a disco and sells tickets.
35% of the school's students each buy a ticket. Each ticket costs \$1.60.
Calculate the total amount received from selling the tickets.

Answer(d) \$ [3]

(e) The cost of running the disco is \$264.
This is an increase of 10% on the cost of running last year's disco.
Calculate the cost of running last year's disco.

Answer(e) \$ [2]



2 40 students are asked about the number of people in their families.

The table shows the results.

Number of people in family	2	3	4	5	6	7
Frequency	1	1	17	12	6	3

(a) Find

(i) the mode,

Answer(a)(i) [1]

(ii) the median,

Answer(a)(ii) [1]

(iii) the mean.

Answer(a)(iii) [3]

(b) Another n students are asked about the number of people in their families.

The mean for these n students is 3.

Find, in terms of n , an expression for the mean number for all $(40 + n)$ students.

Answer(b) [2]

4

3

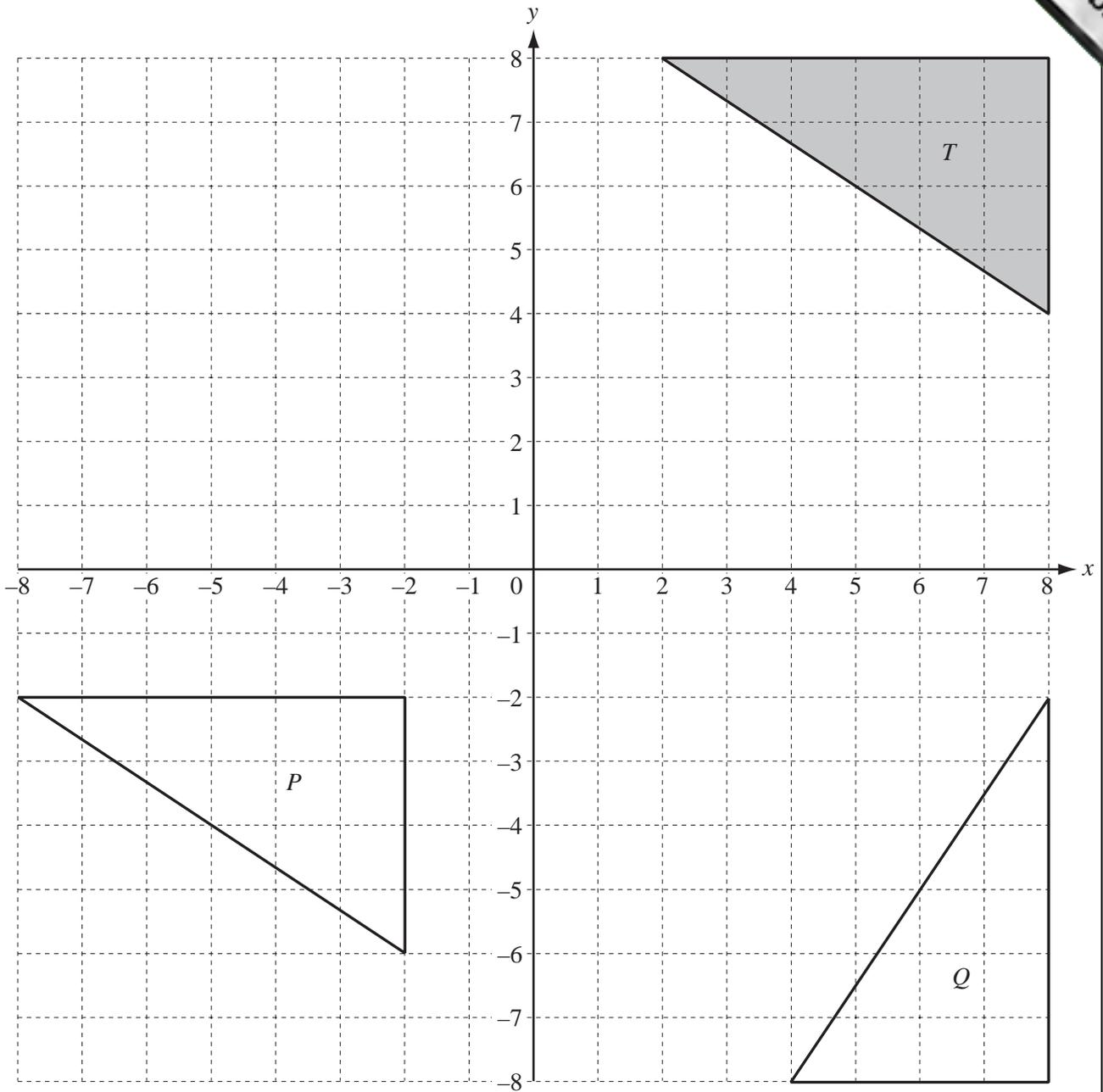

(a) On the grid, draw the enlargement of the triangle T , centre $(0, 0)$, scale factor $\frac{1}{2}$.

[2]

(b) The matrix $\begin{pmatrix} -1 & 0 \\ 0 & 1 \end{pmatrix}$ represents a transformation.

(i) Calculate the matrix product $\begin{pmatrix} -1 & 0 \\ 0 & 1 \end{pmatrix} \begin{pmatrix} 8 & 8 & 2 \\ 4 & 8 & 8 \end{pmatrix}$.

Answer(b)(i) [2]

(ii) On the grid, draw the image of the triangle T under this transformation. [2]

(iii) Describe fully this **single** transformation.

Answer(b)(iii) [2]

(c) Describe fully the **single** transformation which maps

(i) triangle T onto triangle P ,

Answer(c)(i) [2]

(ii) triangle T onto triangle Q .

Answer(c)(ii) [3]

(d) Find the 2 by 2 matrix which represents the transformation in **part (c)(ii)**.

Answer(d) $\begin{pmatrix} & \\ & \end{pmatrix}$ [2]



4

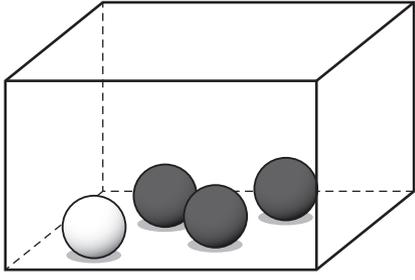

A

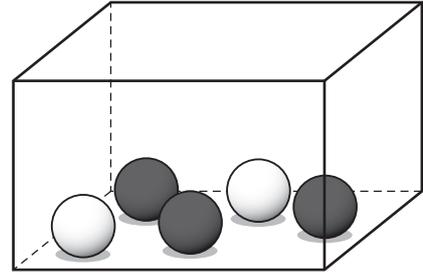

B

Box A contains 3 black balls and 1 white ball.
 Box B contains 3 black balls and 2 white balls.

- (a) A ball can be chosen at random from either box.
 Complete the following statement.

There is a greater probability of choosing a white ball from Box

Explain your answer.

Answer(a) [1]

- (b) Abdul chooses a box and then chooses a ball from this box at random.

The probability that he chooses box A is $\frac{2}{3}$.

- (i) Complete the tree diagram by writing the four probabilities in the empty spaces.

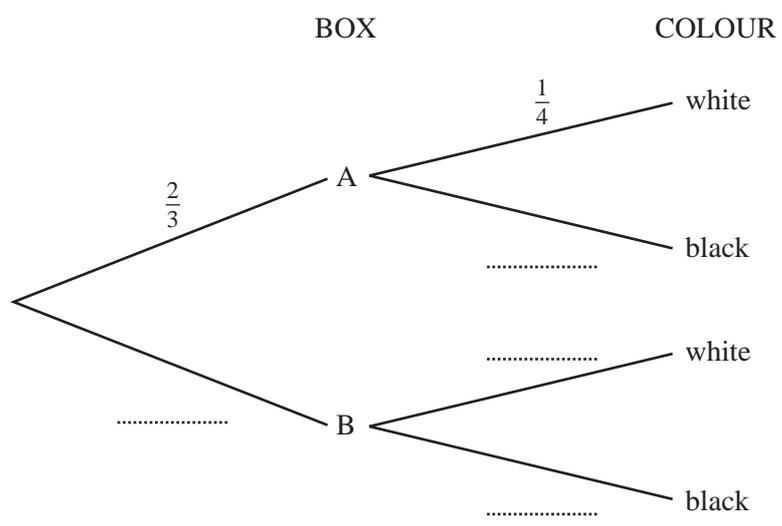

[4]

(ii) Find the probability that Abdul chooses box A and a black ball.

Answer(b)(ii) [2]

(iii) Find the probability that Abdul chooses a black ball.

Answer(b)(iii) [2]

(c) Tatiana chooses a box and then chooses **two** balls from this box at random (without replacement).

The probability that she chooses box A is $\frac{2}{3}$.

Find the probability that Tatiana chooses two white balls.

Answer(c) [2]

5

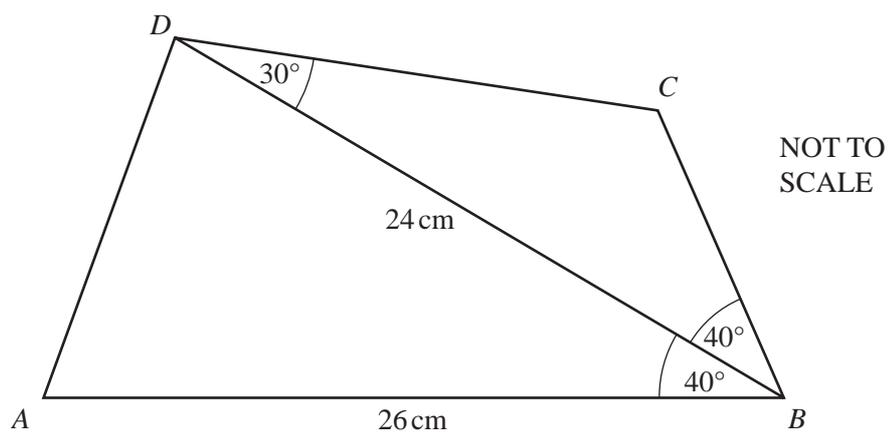

ABCD is a quadrilateral and *BD* is a diagonal.
AB = 26 cm, *BD* = 24 cm, angle *ABD* = 40°, angle *CBD* = 40° and angle *CDB* = 30°.

(a) Calculate the area of triangle *ABD*.

Answer(a) cm² [2]

(b) Calculate the length of *AD*.

Answer(b) cm [4]

(c) Calculate the length of *BC*.

Answer(c) cm [4]

(d) Calculate the shortest distance from the point *C* to the line *BD*.

Answer(d) cm [2]

6 The masses of 60 potatoes are measured.
The table shows the results.

Mass (m grams)	$10 < m \leq 20$	$20 < m \leq 40$	$40 < m \leq 50$
Frequency	10	30	20

(a) Calculate an estimate of the mean.

Answer(a) g [4]

(b) On the grid, draw an accurate histogram to show the information in the table.

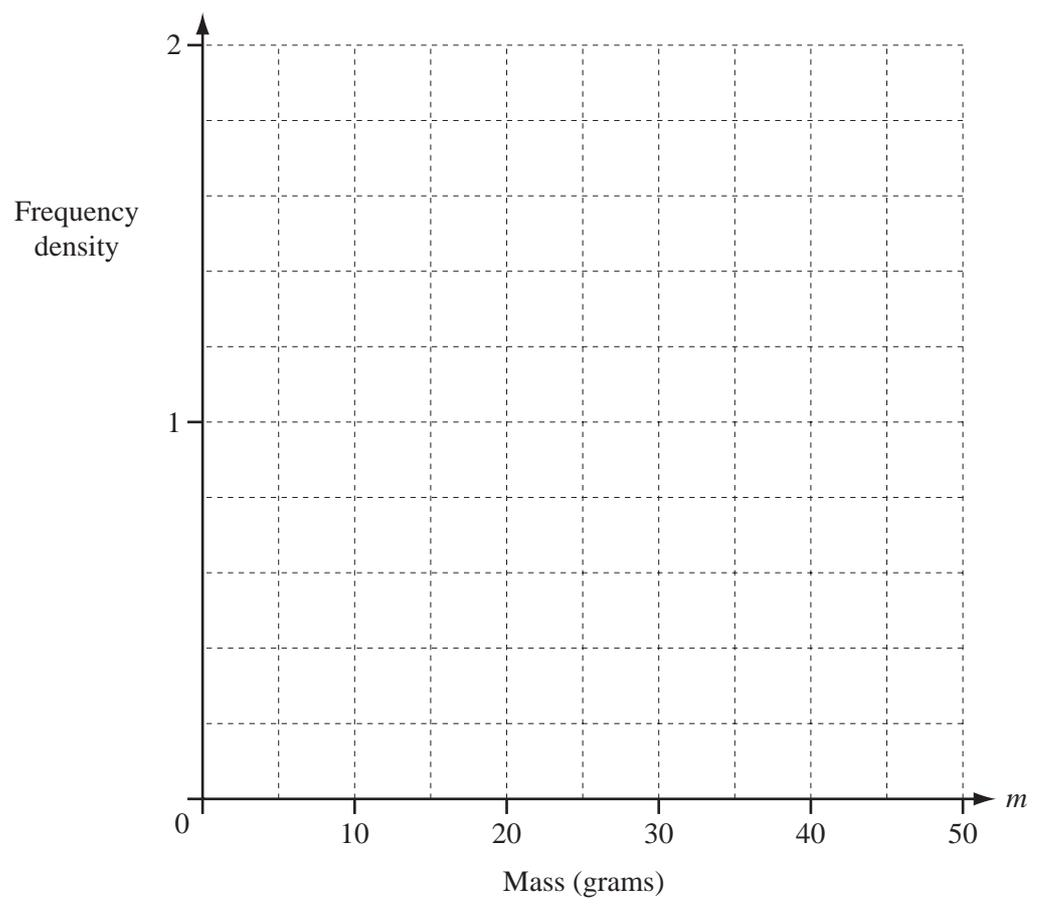

[3]

- 7 (a) Calculate the volume of a cylinder of radius 31 centimetres and length 15 metres.
Give your answer in cubic metres.

Answer(a) m³ [3]

- (b) A tree trunk has a circular cross-section of radius 31 cm and length 15 m.
One cubic metre of the wood has a mass of 800 kg.
Calculate the mass of the tree trunk, giving your answer in tonnes.

Answer(b) tonnes [2]

- (c)

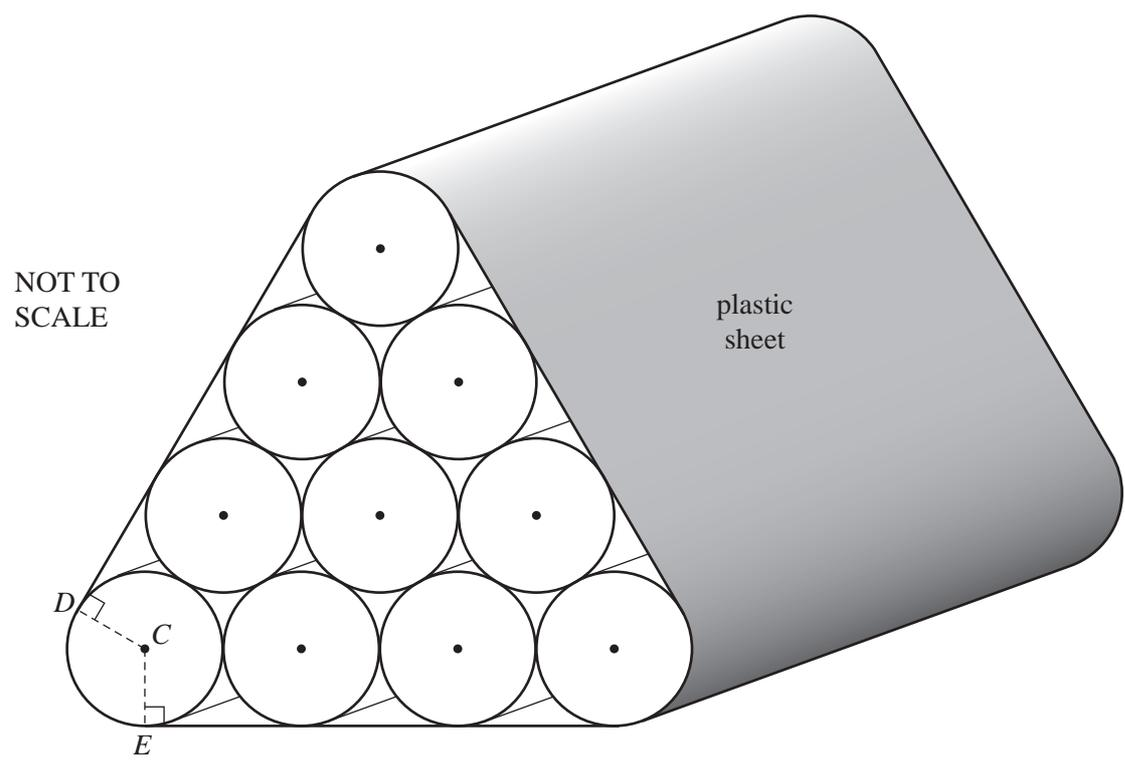

NOT TO SCALE

The diagram shows a pile of 10 tree trunks.
Each tree trunk has a circular cross-section of radius 31 cm and length 15 m.
A plastic sheet is wrapped around the pile.

C is the centre of one of the circles.
CE and CD are perpendicular to the straight edges, as shown.

(i) Show that angle $ECD = 120^\circ$.

Answer(c)(i)

[2]

(ii) Calculate the length of the arc DE , giving your answer in metres.

Answer(c)(ii) m [2]

(iii) The edge of the plastic sheet forms the perimeter of the cross-section of the pile.
The perimeter consists of three straight lines and three arcs.
Calculate this perimeter, giving your answer in metres.

Answer(c)(iii) m [3]

(iv) The plastic sheet does not cover the two ends of the pile.
Calculate the area of the plastic sheet.

Answer(c)(iv) m^2 [1]



8 (a) $f(x) = 2^x$

Complete the table.

x	-2	-1	0	1	2	3	4
$y = f(x)$		0.5	1	2	4		

[3]

(b) $g(x) = x(4 - x)$

Complete the table.

x	-1	0	1	2	3	4
$y = g(x)$		0	3		3	0

[2]

(c) On the grid, draw the graphs of

(i) $y = f(x)$ for $-2 \leq x \leq 4$,

[3]

(ii) $y = g(x)$ for $-1 \leq x \leq 4$.

[3]

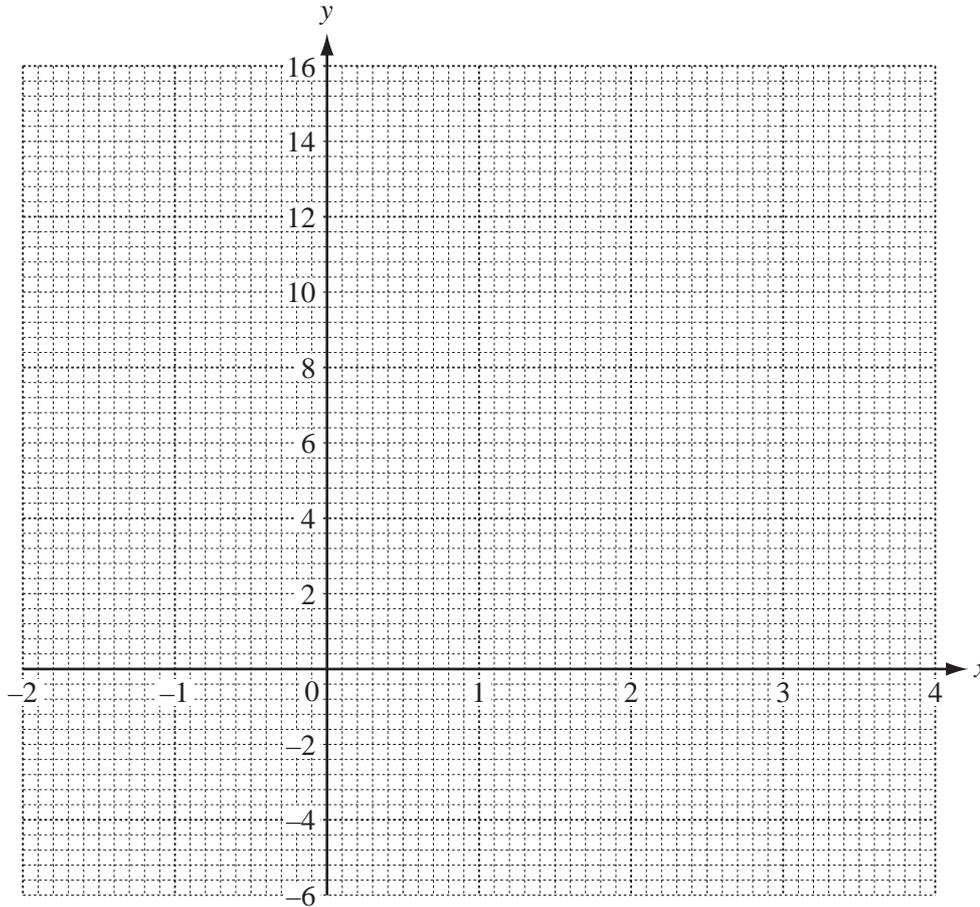

(d) Use your graphs to solve the following equations.

(i) $f(x) = 10$

Answer(d)(i) $x = \dots\dots\dots$ [1]

(ii) $f(x) = g(x)$

Answer(d)(ii) $x = \dots\dots\dots$ or $x = \dots\dots\dots$ [2]

(iii) $f^{-1}(x) = 1.7$

Answer(d)(iii) $x = \dots\dots\dots$ [1]

9 (a) Solve the following equations.

(i) $\frac{5}{w} = \frac{3}{w+1}$

Answer(a)(i) $w =$ [2]

(ii) $(y+1)^2 = 4$

Answer(a)(ii) $y =$ or $y =$ [2]

(iii) $\frac{x+1}{3} - \frac{x-2}{5} = 2$

Answer(a)(iii) $x =$ [3]

(b) (i) Factorise $u^2 - 9u - 10$.

Answer(b)(i) [2]

(ii) Solve the equation $u^2 - 9u - 10 = 0$.

Answer(b)(ii) $u =$ or $u =$ [1]

(c)

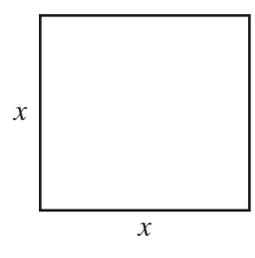
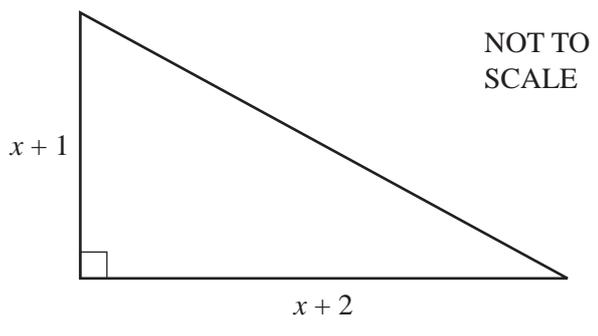

The area of the triangle is equal to the area of the square.
All lengths are in centimetres.

(i) Show that $x^2 - 3x - 2 = 0$.

Answer(c)(i)

[3]

(ii) Solve the equation $x^2 - 3x - 2 = 0$, giving your answers correct to 2 decimal places.
Show all your working.

Answer(c)(ii) $x =$ or $x =$ [4]

(iii) Calculate the area of one of the shapes.

Answer(c)(iii) cm^2 [1]

10 A company has a vehicle parking area of 1200 m^2 with space for x cars and y trucks.

Each car requires 20 m^2 of space and each truck requires 100 m^2 of space.

(a) Show that $x + 5y \leq 60$.

Answer(a)

[1]

(b) There must also be space for

(i) at least 40 vehicles,

(ii) at least 2 trucks.

Write down two more inequalities to show this information.

Answer(b)(i) [1]

Answer(b)(ii) [1]

(c) One line has been drawn for you.

On the grid, show the three inequalities by drawing the other two lines and shading the **unwanted** regions.

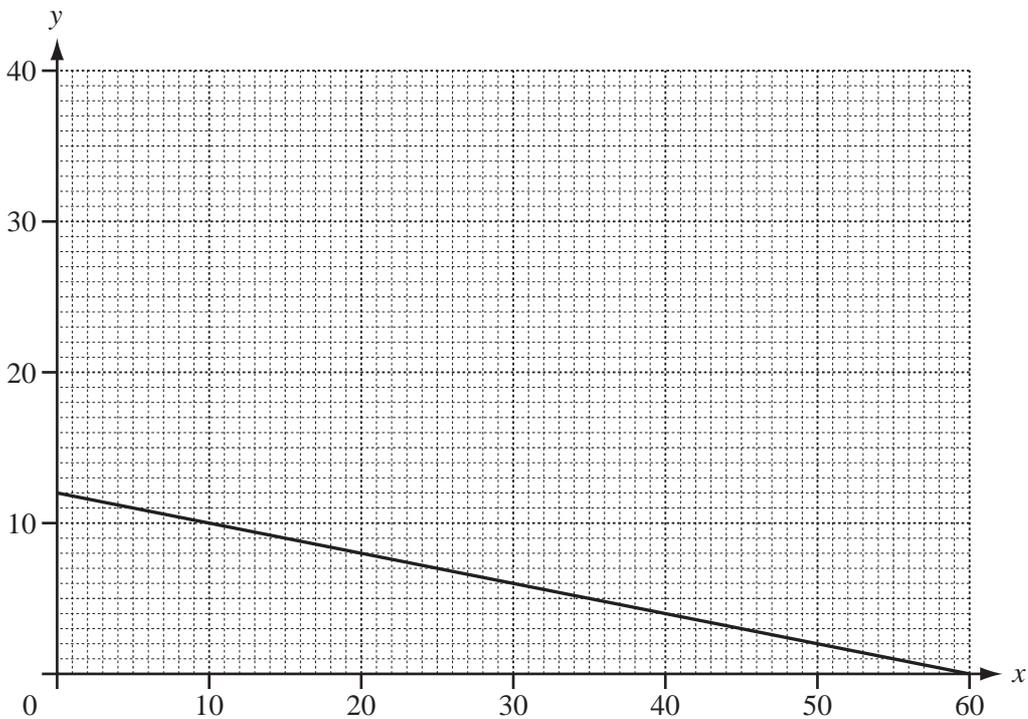

[4]

(d) Use your graph to find the largest possible number of trucks.

Answer(d) [1]

(e) The company charges \$5 for parking each car and \$10 for parking each truck.
Find the number of cars and the number of trucks which give the company the greatest possible income.

Calculate this income.

Answer(e) Number of cars =

Number of trucks =

Greatest possible income = \$ [3]

11

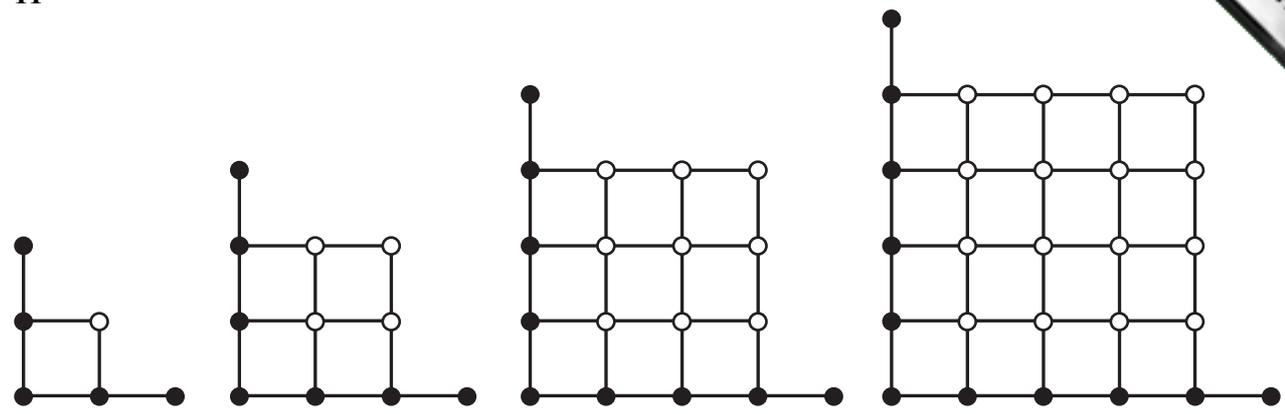

Diagram 1

1 white dot
 5 black dots
 6 lines

Diagram 2

4 white dots
 7 black dots
 14 lines

Diagram 3

9 white dots
 9 black dots
 26 lines

Diagram 4

16 white dots
 11 black dots
 42 lines

The four diagrams above are the first four of a pattern.

(a) Diagram 5 has been started below.

Complete this diagram and write down the information about the numbers of dots and lines.

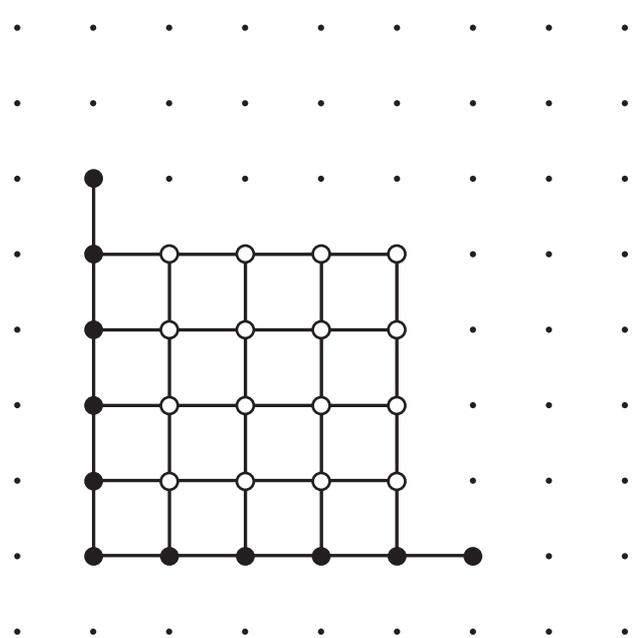
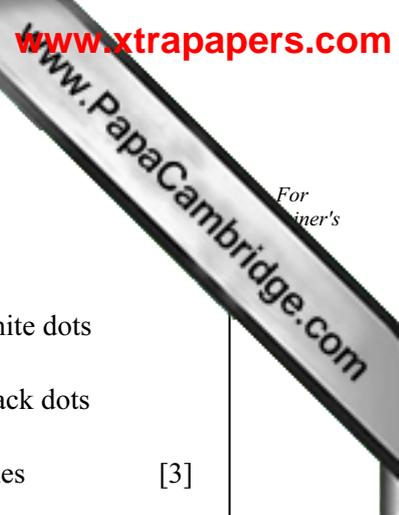

Diagram 5

..... white dots

..... black dots

..... lines



(b) Complete the information about the number of dots and lines in Diagram 8.

Answer(b) white dots
 black dots
 lines [3]

(c) Complete the information about the number of dots in Diagram n .
Give your answers in terms of n .

Answer(c) white dots
 black dots [2]

(d) The number of lines in diagram n is $k(n^2 + n + 1)$.

Find

(i) the value of k ,

Answer(d)(i) $k =$ [1]

(ii) the number of lines in Diagram 100.

Answer(d)(ii) [1]



