



Cambridge Assessment International Education
Cambridge International General Certificate of Secondary Education

CANDIDATE
NAME

CENTRE
NUMBER

--	--	--	--	--

CANDIDATE
NUMBER

--	--	--	--



MATHEMATICS

0580/33

Paper 3 (Core)

October/November 2019

2 hours

Candidates answer on the Question Paper.

Additional Materials: Electronic calculator
 Tracing paper (optional)

Geometrical instruments

READ THESE INSTRUCTIONS FIRST

Write your centre number, candidate number and name on all the work you hand in.

Write in dark blue or black pen.

You may use an HB pencil for any diagrams or graphs.

Do not use staples, paper clips, glue or correction fluid.

DO NOT WRITE IN ANY BARCODES.

Answer **all** questions.

If working is needed for any question it must be shown below that question.

Electronic calculators should be used.

If the degree of accuracy is not specified in the question, and if the answer is not exact, give the answer to three significant figures. Give answers in degrees to one decimal place.

For π , use either your calculator value or 3.142.

At the end of the examination, fasten all your work securely together.

The number of marks is given in brackets [] at the end of each question or part question.

The total of the marks for this paper is 104.

This document consists of **16** printed pages.

1 (a) Write $\frac{1}{4}$ as a decimal.

..... [1]

(b) Write $\frac{36}{124}$ as a fraction in its lowest terms.

..... [1]

(c) Work out $\frac{5}{8}$ of 128.

..... [1]

(d) Write down all the factors of 24.

..... [2]

(e) Find the highest common factor (HCF) of 24 and 108.

..... [2]

(f) Write down an irrational number between 3 and 9.

..... [1]

- (g) Write down the value of 25^0 .

..... [1]

- (h) \$8400 is invested for 2 years at a rate of 3.5% per year compound interest.

Work out the total amount of interest earned by the end of the 2 years.

\$..... [3]

- (i) **Without using a calculator**, work out $2\frac{1}{3} + \frac{4}{5}$.

You must show all your working and give your answer as a mixed number in its simplest form.

..... [3]

- 2 (a) Emma records the number of letters in each word in a sentence.

7 1 5 4 2 4 5 3 3 1 2 4

Find

- (i) the median,

..... [2]

- (ii) the mode,

..... [1]

- (iii) the range.

..... [1]

- (b) Jack records the number of letters in 25 words.

Number of letters in a word	Number of words
1	3
2	1
3	5
4	8
5	6
6	2

- (i) Calculate the mean.

..... [3]

- (ii) Priti picks one of Jack's words at random.

Find the probability that this word has 4 or more letters.

..... [2]

(c) The table shows information about the first 90 words in a book.

(i) Complete the table.

Length of word	Frequency	Pie chart angle
Very short	6	24°
Short	34	
Medium	41	
Long	9	

[2]

(ii) Complete the pie chart to show this information.

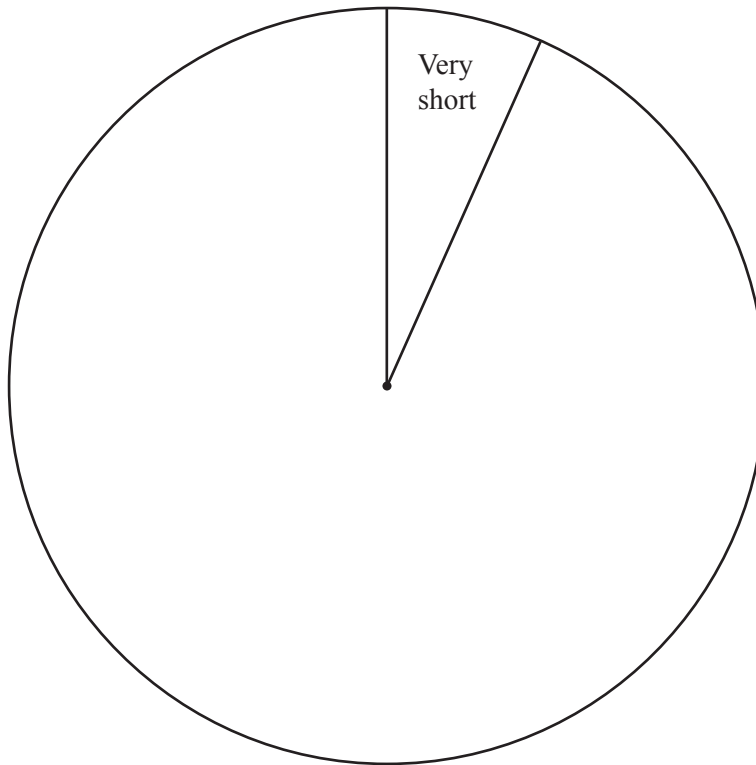

[2]

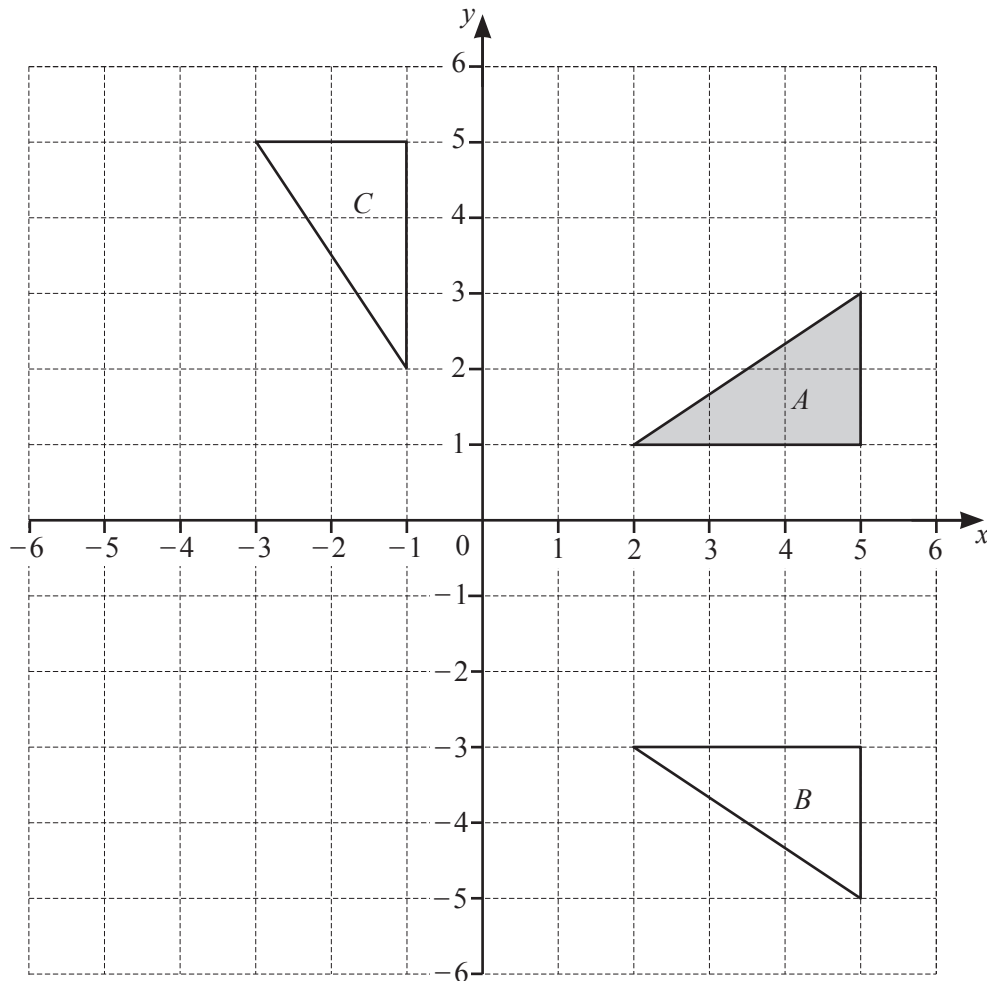

- (a) Describe fully the **single** transformation that maps triangle *A* onto triangle *B*.

.....
 [2]

- (b) Describe fully the **single** transformation that maps triangle *A* onto triangle *C*.

.....
 [3]

- (c) On the grid, draw the image of triangle *A* after a translation by the vector $\begin{pmatrix} -2 \\ -3 \end{pmatrix}$. [2]

- (d) On the grid, draw the image of triangle *A* after a rotation of 180° about $(2, 1)$. [2]

- 4 (a) A plane leaves Karachi at 15 30 to fly to Bangkok.
The distance is 3840 km.

The plane flies at an average speed of 720 km/h.
The local time in Bangkok is 2 hours ahead of the local time in Karachi.

Find the local time in Bangkok when the plane arrives.

..... [4]

- (b) In Bangkok a watch costs 2610 baht.
The exchange rate is \$1 = 34.8 baht.

Find the cost of the watch in dollars.

\$..... [2]

- (c) The price of another watch increases from \$18 to \$19.17 .

Find the percentage increase in the price of this watch.

..... % [3]

- (d) Raoul makes a profit when he sells his watch for \$36.
The ratio of the price Raoul paid for the watch and the profit he makes is price paid : profit = 7 : 2.

Work out the profit that Raoul makes.

\$..... [2]

5 (a) Simplify.

$$9x - 2y - 5x - y$$

..... [2]

(b) $P = 4ab + 3b^2$

Work out the value of a when $P = 35$ and $b = 5$.

$a =$ [3]

(c) Solve.

(i) $10x = 5$

$x =$ [1]

(ii) $7x - 3 = 2x + 11$

$x =$ [2]

(iii) $3(2x - 1) = 27$

$x =$ [3]

(d) Rearrange $T = 5(p + 2)$ to make p the subject.

$p = \dots\dots\dots$ [2]

(e) Solve the simultaneous equations.
You must show all your working.

$$3x - y = 22$$

$$x + 2y = 5$$

$x = \dots\dots\dots$

$y = \dots\dots\dots$ [3]

- 6 (a) The scale drawing shows the positions of town *A* and town *B*.
The scale is 1 centimetre represents 12 kilometres.

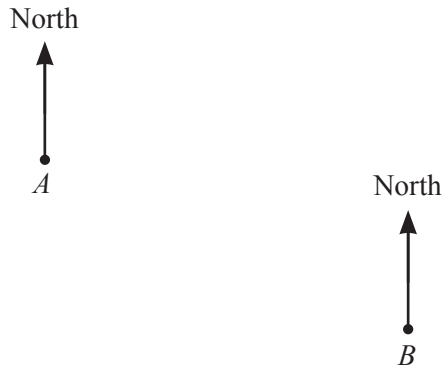

Scale: 1 cm to 12 km

- (i) Measure the bearing of town *B* from town *A*.

..... [1]

- (ii) Find the actual distance from town *A* to town *B*.

..... km [2]

- (iii) Town *C* is on a bearing of 064° from town *A* and 028° from town *B*.

On the scale drawing, mark the position of town *C*. [2]

(b) The bearing of town D from town E is 245° .

Work out the bearing of town E from town D .

..... [2]

(c) The diagram shows three towns, P , Q and R .

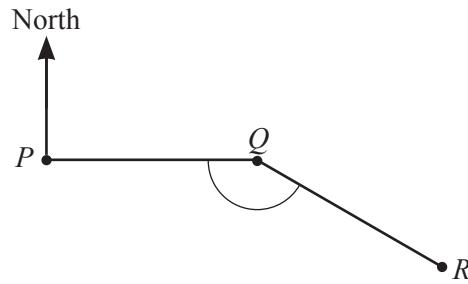

NOT TO SCALE

The bearing of town Q from town P is 090° .

(i) Complete the statement.

Town is due west of town [1]

(ii) PQ and QR are two sides of a regular decagon.

Work out angle PQR .

Angle $PQR =$ [3]

7 (a) The diagram shows a shape made from two rectangles.

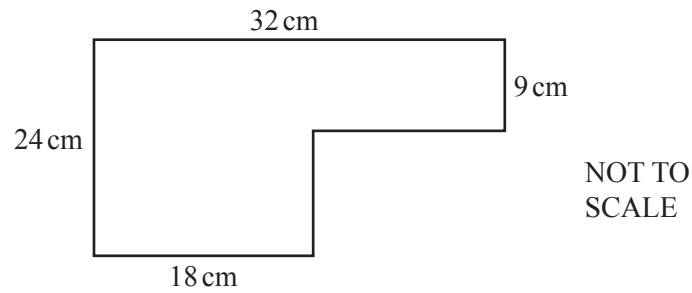

(i) Work out the perimeter.

..... cm [2]

(ii) Work out the area.

..... cm² [2]

(b) The diagram shows a triangle between two parallel lines, *AB* and *CD*.

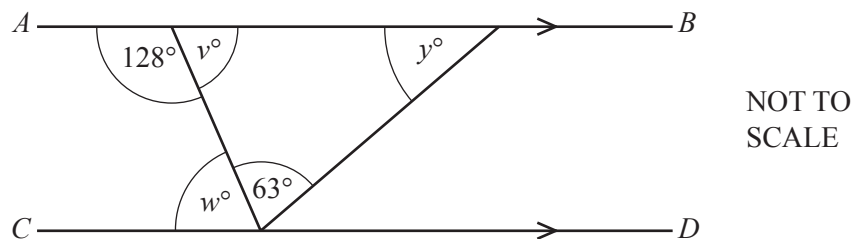

Find the value of

(i) *v*,

v = [1]

(ii) *w*,

w = [1]

(iii) *y*.

y = [1]

(c) These two cuboids have the same volume.

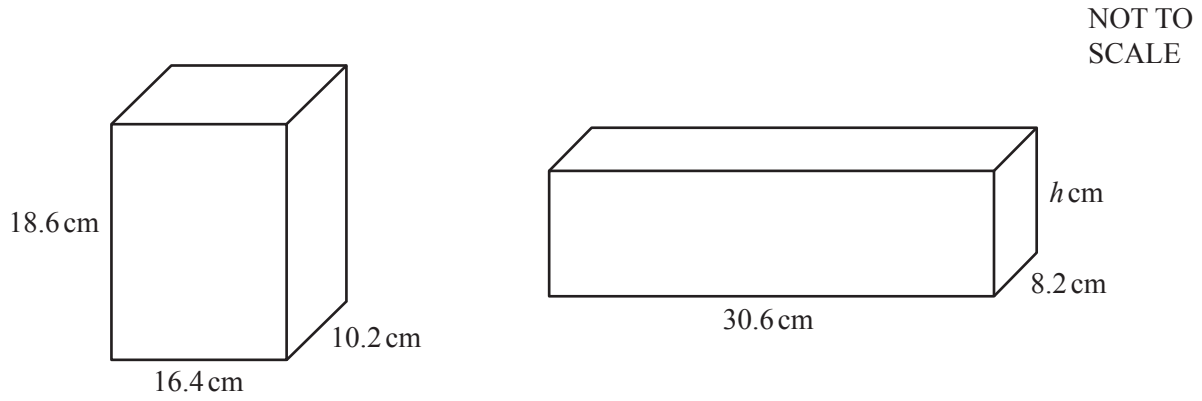

Find the value of h .

$h = \dots\dots\dots$ [3]

(d) The diagram shows two similar triangles, ABC and DEF .

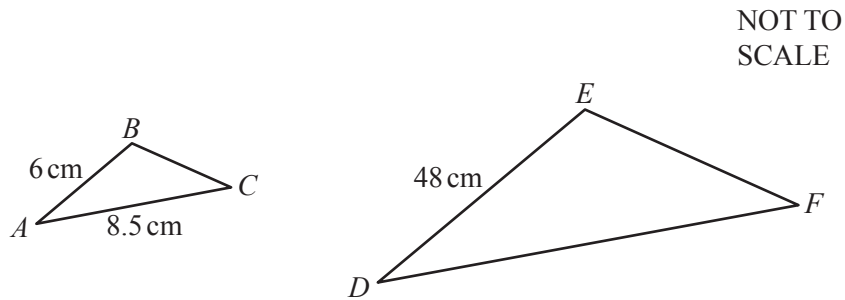

Calculate DF .

$DF = \dots\dots\dots$ cm [2]

- 8 (a) (i) Complete the table of values for $y = x^2 - 2x$.

x	-2	-1	0	1	2	3	4
y	8		0	-1	0		8

[1]

- (ii) On the grid, draw the graph of $y = x^2 - 2x$ for $-2 \leq x \leq 4$.

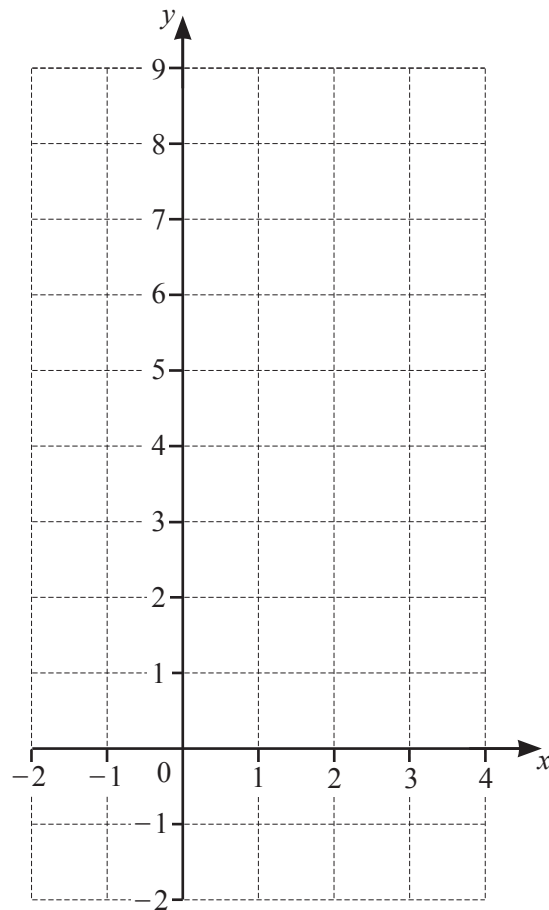

[4]

(b) Here are the first four terms of a sequence.

3 9 15 21

(i) Find the next term.

..... [1]

(ii) Write down the rule for continuing this sequence.

..... [1]

(iii) Find the n th term of this sequence.

..... [2]

Question 9 is printed on the next page.

- 9 (a) By rounding each number correct to 1 significant figure, show that an estimate for this calculation is 20.

$$\frac{9.78 + 31.562}{0.381 \times 5.09}$$

[2]

- (b) Write these numbers in order, smallest first.

$$\frac{22}{7} \quad 3.142 \quad \frac{333}{106} \quad 3.1416$$

$$\dots\dots\dots < \dots\dots\dots < \dots\dots\dots < \dots\dots\dots \quad [2]$$

smallest

- (c) The length, p cm, of a pencil is 9.8 cm, correct to 2 significant figures.

Complete the statement about the value of p .

$$\dots\dots\dots \leq p < \dots\dots\dots \quad [2]$$

- (d) Calculate $3.142 - \frac{52163}{16604}$.

Give your answer in standard form correct to 2 significant figures.

$$\dots\dots\dots \quad [2]$$

Permission to reproduce items where third-party owned material protected by copyright is included has been sought and cleared where possible. Every reasonable effort has been made by the publisher (UCLES) to trace copyright holders, but if any items requiring clearance have unwittingly been included, the publisher will be pleased to make amends at the earliest possible opportunity.

To avoid the issue of disclosure of answer-related information to candidates, all copyright acknowledgements are reproduced online in the Cambridge Assessment International Education Copyright Acknowledgements Booklet. This is produced for each series of examinations and is freely available to download at www.cambridgeinternational.org after the live examination series.

Cambridge Assessment International Education is part of the Cambridge Assessment Group. Cambridge Assessment is the brand name of the University of Cambridge Local Examinations Syndicate (UCLES), which itself is a department of the University of Cambridge.