



Cambridge IGCSE™ (9–1)

CANDIDATE
NAME

CENTRE
NUMBER

--	--	--	--	--

CANDIDATE
NUMBER

--	--	--	--

MATHEMATICS

0980/42

Paper 4 (Extended)

May/June 2021

2 hours 30 minutes

You must answer on the question paper.

You will need: Geometrical instruments

INSTRUCTIONS

- Answer **all** questions.
- Use a black or dark blue pen. You may use an HB pencil for any diagrams or graphs.
- Write your name, centre number and candidate number in the boxes at the top of the page.
- Write your answer to each question in the space provided.
- Do **not** use an erasable pen or correction fluid.
- Do **not** write on any bar codes.
- You should use a calculator where appropriate.
- You may use tracing paper.
- You must show all necessary working clearly.
- Give non-exact numerical answers correct to 3 significant figures, or 1 decimal place for angles in degrees, unless a different level of accuracy is specified in the question.
- For π , use either your calculator value or 3.142.

INFORMATION

- The total mark for this paper is 130.
- The number of marks for each question or part question is shown in brackets [].

This document has **16** pages.



- 1 (a) A 2.5-litre tin of paint costs \$13.50 .
In a sale, the cost is reduced by 14%.

(i) Work out the sale price of this tin of paint.

\$ [2]

(ii) Work out the cost of buying 42.5 litres of paint at this sale price.

\$ [2]

- (b) Henri buys some paint in the ratio red paint : white paint : green paint = 2 : 8 : 5.

(i) Find the percentage of this paint that is white.

..... % [1]

(ii) Henri buys a total of 22.5 litres of paint.

Find the number of litres of green paint he buys.

..... litres [2]

- (c) Maria paints a rectangular wall.

The length of the wall is 20.5 m and the height is 2.4 m, both correct to 1 decimal place.

One litre of paint covers an area of exactly 10 m^2 .

Calculate the smallest number of 2.5-litre tins of paint she will need to be sure all the wall is painted.

Show all your working.

..... [4]

2 The table shows some values for $y = 2 \times 0.5^x - 1$.

x	-1	-0.5	0	0.5	1	1.5	2
y	3	1.83		0.41	0	-0.29	

- (a) (i) Complete the table. [2]
- (ii) On the grid, draw the graph of $y = 2 \times 0.5^x - 1$ for $-1 \leq x \leq 2$.

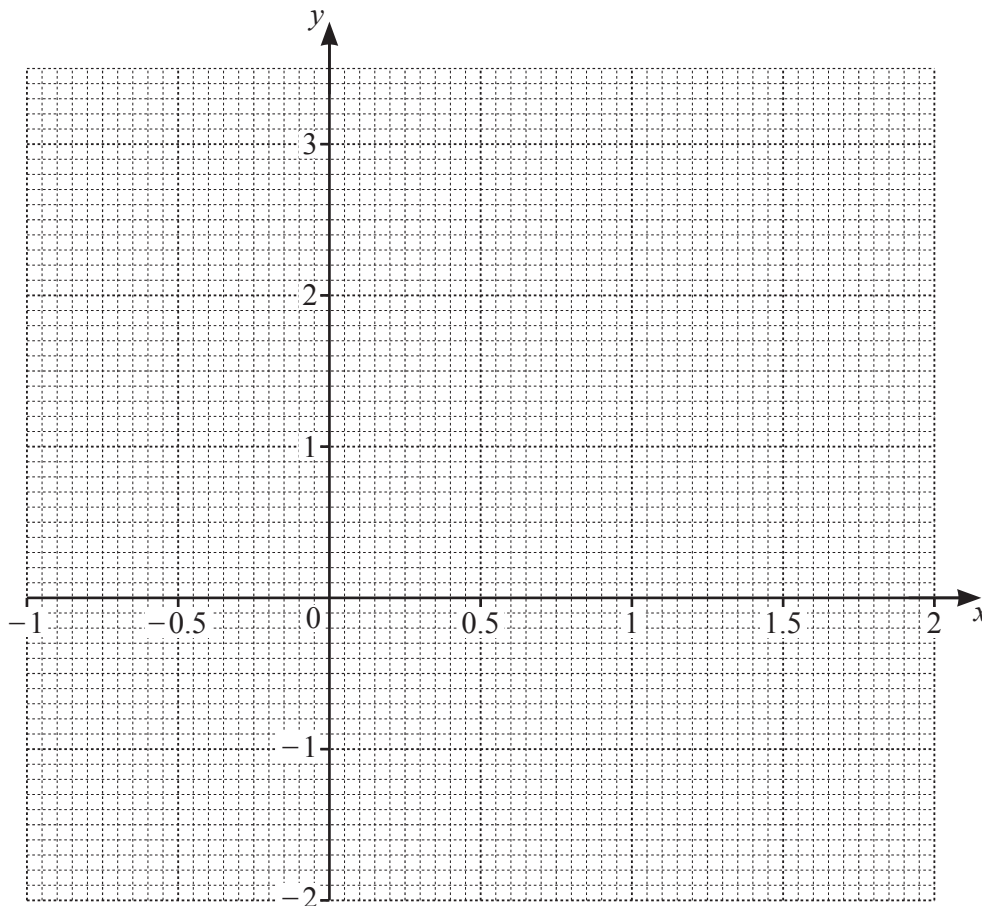

[4]

(b) By drawing a suitable straight line, solve the equation $2 \times 0.5^x + 2x - 3.5 = 0$ for $-1 \leq x \leq 2$.

$x = \dots\dots\dots$ [3]

(c) There are no solutions to the equation $2 \times 0.5^x - 1 = k$ where k is an integer.

Complete the following statements.

The highest possible value of k is

The equation of the asymptote to the graph of $y = 2 \times 0.5^x - 1$ is [2]

3 (a) Simplify, giving your answer as a single power of 7.

(i) $7^5 \times 7^6$

..... [1]

(ii) $7^{15} \div 7^5$

..... [1]

(iii) $42 + 7$

..... [1]

(b) Simplify.

$(5x^2 \times 2xy^4)^3$

..... [3]

(c) $P = 2^5 \times 3^3 \times 7$ $Q = 540$

(i) Find the highest common factor (HCF) of P and Q .

..... [2]

(ii) Find the lowest common multiple (LCM) of P and Q .

..... [2]

(iii) $P \times R$ is a cube number, where R is an integer.

Find the smallest possible value of R .

..... [2]

(d) Factorise the following completely.

(i) $x^2 - 3x - 28$

..... [2]

(ii) $7(a+2b)^2 + 4a(a+2b)$

..... [2]

(e) $3^{2x-1} = \frac{1}{9^x} \times 3^{2y-x}$

Find an expression for y in terms of x .

$y =$ [4]

- 4 (a) The mass, m kg, of each of 40 parcels in a warehouse is recorded.
The table shows information about the masses of these parcels.

Mass (m kg)	$0.5 < m \leq 1$	$1 < m \leq 2$	$2 < m \leq 4$	$4 < m \leq 7$	$7 < m \leq 12$
Frequency	4	7	15	10	4

- (i) Complete the histogram to show this information.

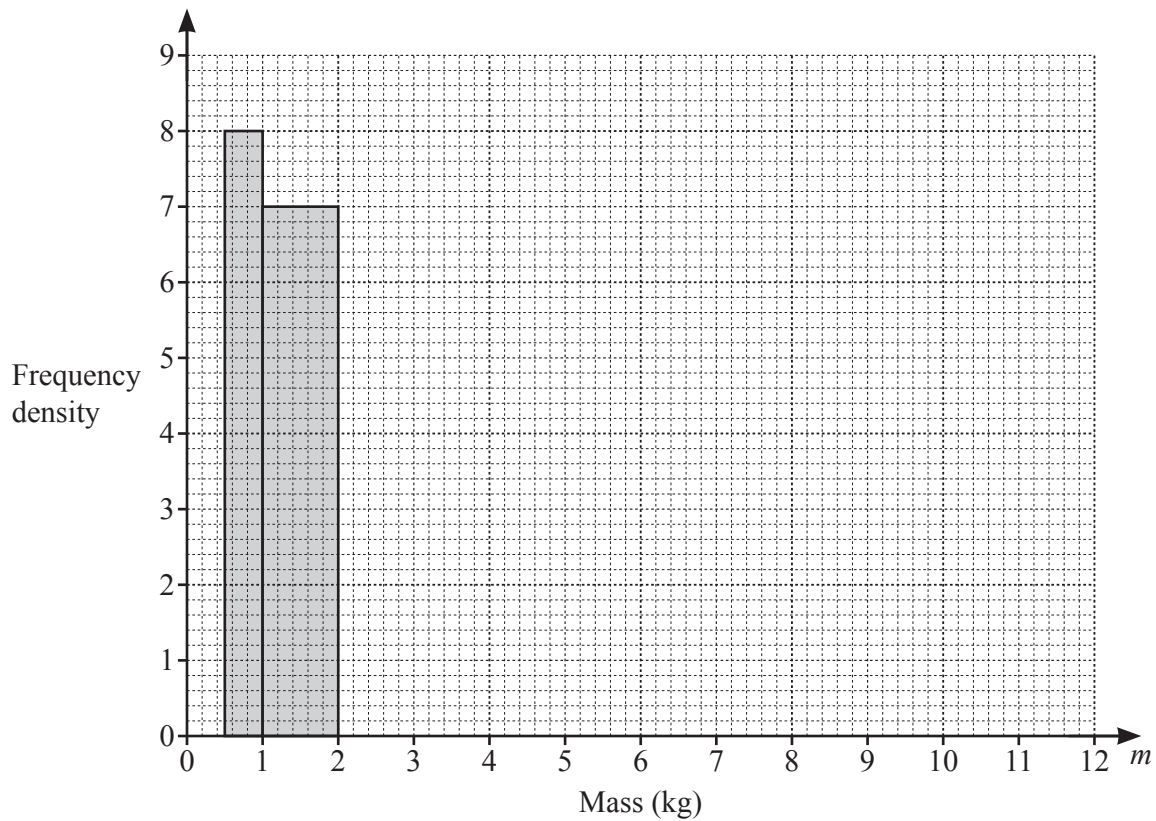

[3]

- (ii) Calculate an estimate of the mean mass of the parcels.

..... kg [4]

- (iii) A parcel is picked at random from the 40 parcels.

Find the probability that this parcel has a mass of 2 kg or less.

..... [1]

- (iv) Two parcels are picked at random without replacement from those with a mass **greater than 2 kg**.

Work out the probability that one of them has a mass greater than 7 kg and the other has a mass of 4 kg or less.

..... [3]

- (b) A van delivers parcels from a different warehouse.
The box-and-whisker plot shows information about the masses of the parcels in the van.

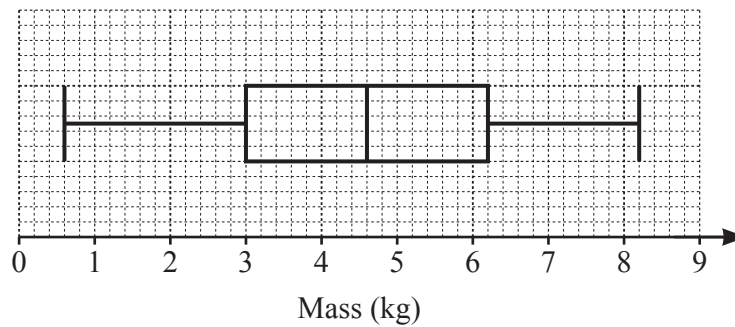

- (i) Find the median.

..... kg [1]

- (ii) Find the interquartile range.

..... kg [1]

- (iii) Two parcels are removed from the van at the first delivery.
The masses of these parcels are 2.4 kg and 5.8 kg.

Describe the effect that removing these parcels has on the median mass of the remaining parcels.

Give a reason for your answer.

.....
..... [2]

5 (a) $\mathbf{a} = \begin{pmatrix} -3 \\ 8 \end{pmatrix}$ $\mathbf{b} = \begin{pmatrix} 2 \\ -5 \end{pmatrix}$

(i) Find

(a) $\mathbf{b} - \mathbf{a}$,

$$\begin{pmatrix} \\ \end{pmatrix} \quad [1]$$

(b) $2\mathbf{a} + \mathbf{b}$,

$$\begin{pmatrix} \\ \end{pmatrix} \quad [2]$$

(c) $|\mathbf{b}|$.

..... [2]

(ii) $\mathbf{a} + k\mathbf{b} = \begin{pmatrix} 13 \\ m \end{pmatrix}$, where k and m are integers.

Find the value of k and the value of m .

$$k = \dots\dots\dots$$

$$m = \dots\dots\dots [3]$$

(b)

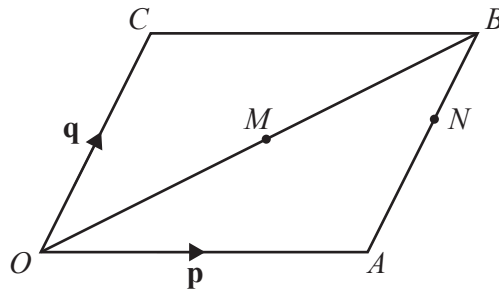
NOT TO
SCALE

$OACB$ is a parallelogram and O is the origin.

M is the midpoint of OB .

N is the point on AB such that $AN : NB = 3 : 2$.

$\vec{OA} = \mathbf{p}$ and $\vec{OC} = \mathbf{q}$.

(i) Find, in terms of \mathbf{p} and \mathbf{q} , in its simplest form.

(a) \vec{OB}

$$\vec{OB} = \dots\dots\dots [1]$$

(b) \vec{CM}

$$\vec{CM} = \dots\dots\dots [2]$$

(c) \vec{MN}

$$\vec{MN} = \dots\dots\dots [2]$$

(ii) CB and ON are extended to meet at D .

Find the position vector of D in terms of \mathbf{p} and \mathbf{q} .

Give your answer in its simplest form.

..... [3]

6

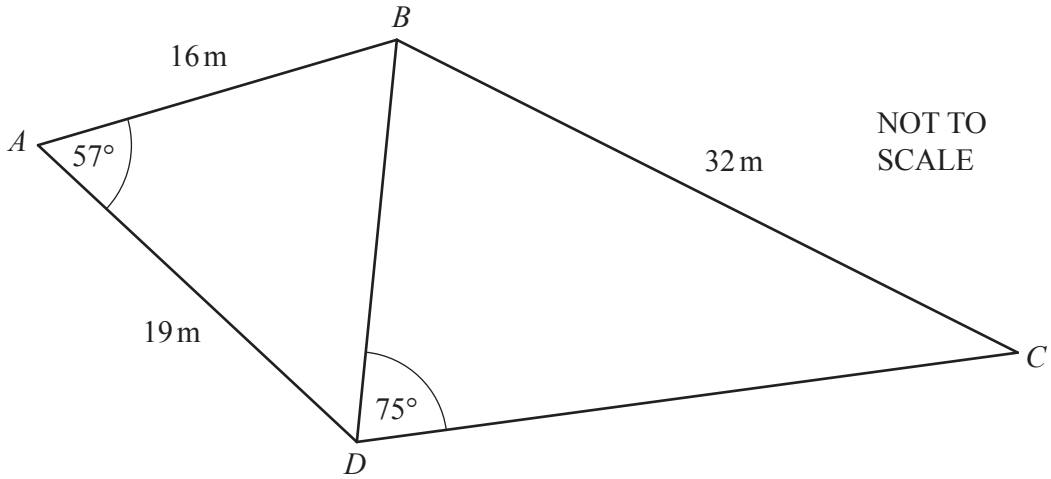

The diagram shows a quadrilateral $ABCD$ made from two triangles, ABD and BCD .

(a) Show that $BD = 16.9$ m, correct to 1 decimal place.

[3]

(b) Calculate angle CBD .

Angle $CBD = \dots\dots\dots$ [4]

(c) Find the area of the quadrilateral $ABCD$.

$\dots\dots\dots \text{m}^2$ [3]

(d) Find the shortest distance from B to AD .

..... m [3]

7

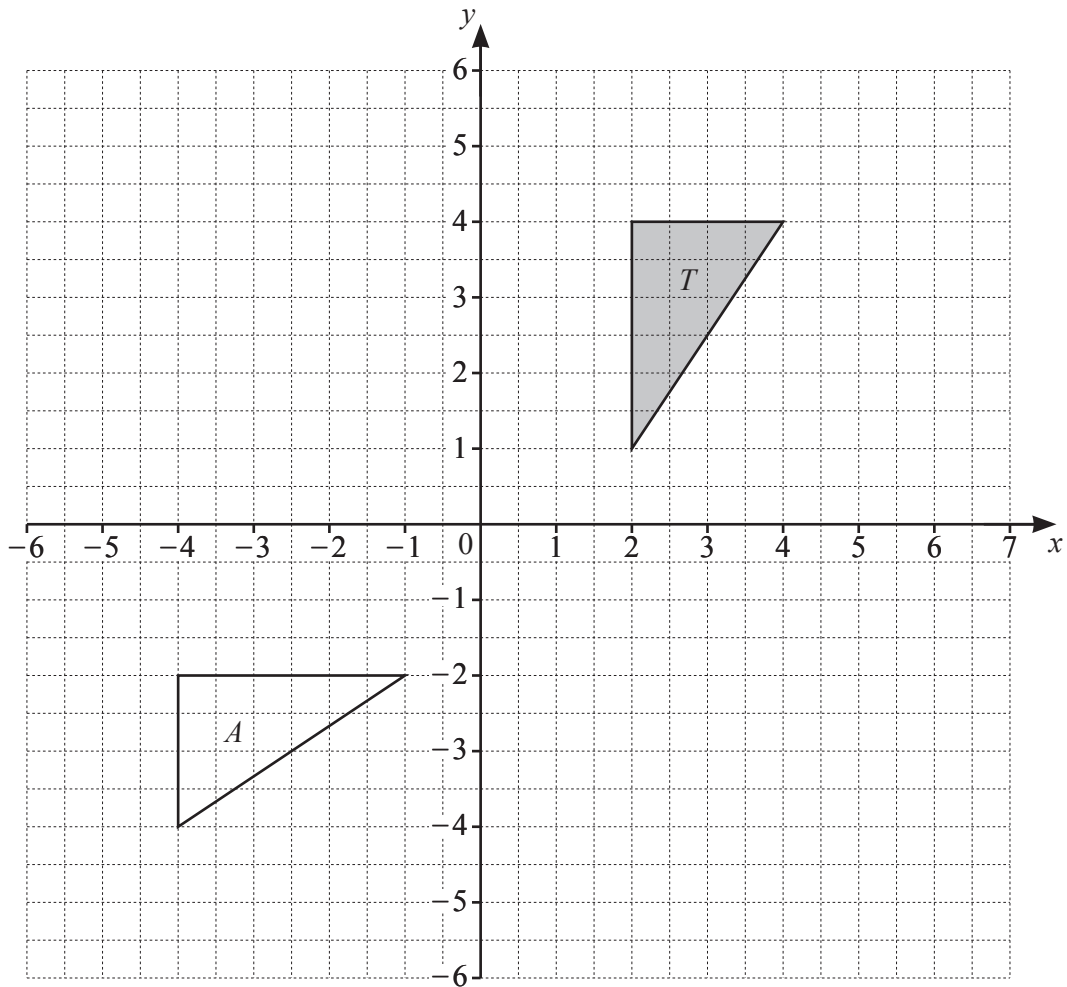

(a) On the grid, draw the image of

(i) triangle T after a translation by the vector $\begin{pmatrix} 2 \\ -1 \end{pmatrix}$, [2]

(ii) triangle T after a rotation, 90° clockwise, about the origin, [2]

(iii) triangle T after an enlargement, scale factor $-\frac{1}{2}$, centre $(-2, 3)$. [2]

(b) Describe fully the **single** transformation that maps triangle T onto triangle A .

..... [2]

- 8 (a) A cuboid has length L cm, width W cm and height H cm.

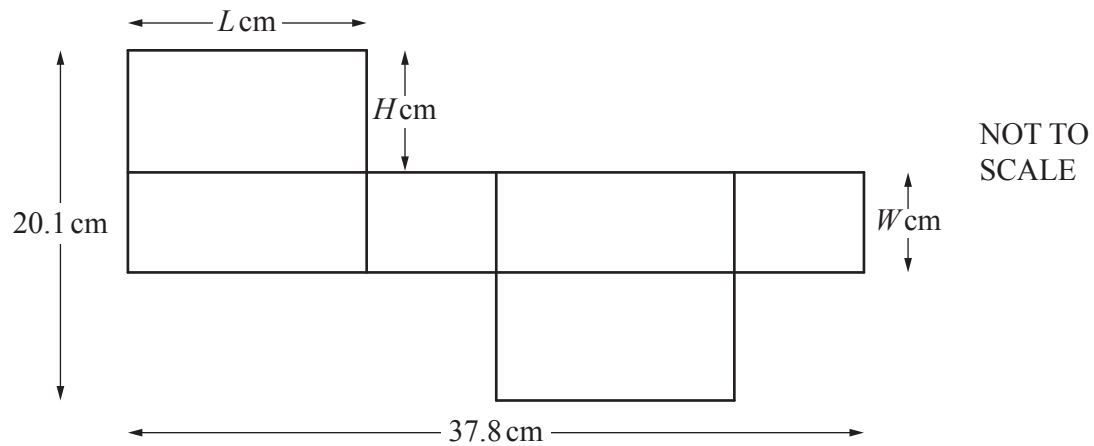

The diagram shows the net of this cuboid.

The ratio $W : L = 1 : 2$.

Find the value of L , the value of W and the value of H .

$$L = \dots\dots\dots$$

$$W = \dots\dots\dots$$

$$H = \dots\dots\dots [5]$$

(b)

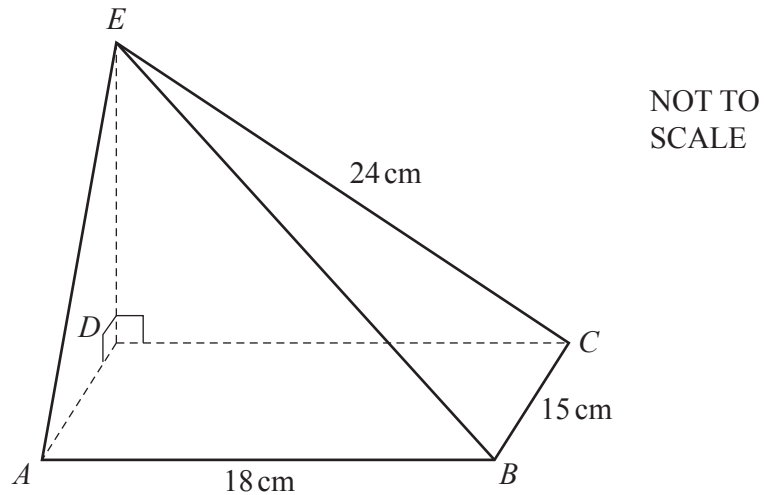

The diagram shows a solid pyramid with a rectangular base $ABCD$.

E is vertically above D .

Angle $EDC = \text{angle } EDA = 90^\circ$.

$AB = 18 \text{ cm}$, $BC = 15 \text{ cm}$ and $EC = 24 \text{ cm}$.

- (i) The pyramid is made of wood and has a mass of 800 g.

Calculate the density of the wood.

Give the units of your answer.

[The volume, V , of a pyramid is $V = \frac{1}{3} \times \text{area of base} \times \text{height}$.]

[Density = mass \div volume]

..... [5]

- (ii) Calculate the angle between BE and the base of the pyramid.

..... [4]
[Turn over

- 9 (a) (i) The equation $y = x^3 - 4x^2 + 4x$ can be written as $y = x(x-a)^2$.

Find the value of a .

$a = \dots\dots\dots$ [2]

- (ii) On the axes, sketch the graph of $y = x^3 - 4x^2 + 4x$, indicating the values where the graph meets the axes.

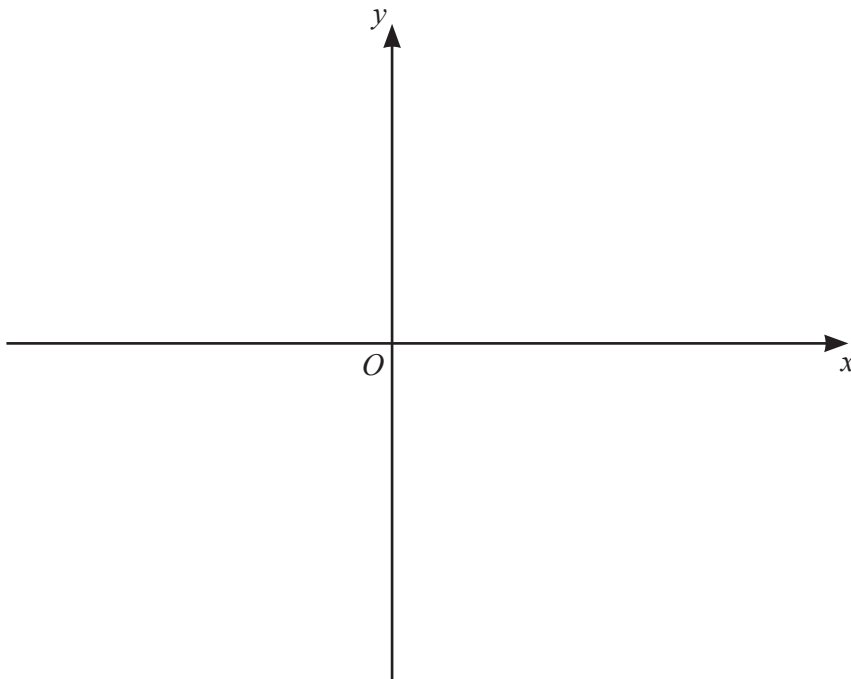

[4]

- (b) Find the equation of the tangent to the graph of $y = x^3 - 4x^2 + 4x$ at $x = 4$.
Give your answer in the form $y = mx + c$.

$y = \dots\dots\dots$ [7]

Question 10 is printed on the next page.

10 The table shows four sequences A , B , C and D .

Sequence	1st term	2nd term	3rd term	4th term	5th term		n th term
A	1	8	27	64			
B	5	11	17	23			
C	0.25	0.5	1	2	4		
D	4.75	10.5	16	21			

Complete the table.

[9]

Permission to reproduce items where third-party owned material protected by copyright is included has been sought and cleared where possible. Every reasonable effort has been made by the publisher (UCLES) to trace copyright holders, but if any items requiring clearance have unwittingly been included, the publisher will be pleased to make amends at the earliest possible opportunity.

To avoid the issue of disclosure of answer-related information to candidates, all copyright acknowledgements are reproduced online in the Cambridge Assessment International Education Copyright Acknowledgements Booklet. This is produced for each series of examinations and is freely available to download at www.cambridgeinternational.org after the live examination series.

Cambridge Assessment International Education is part of the Cambridge Assessment Group. Cambridge Assessment is the brand name of the University of Cambridge Local Examinations Syndicate (UCLES), which itself is a department of the University of Cambridge.