



Cambridge IGCSE™ (9–1)

CANDIDATE
NAME

CENTRE
NUMBER

--	--	--	--	--

CANDIDATE
NUMBER

--	--	--	--

MATHEMATICS

0980/11

Paper 1 (Core)

October/November 2022

1 hour

You must answer on the question paper.

You will need: Geometrical instruments

INSTRUCTIONS

- Answer **all** questions.
- Use a black or dark blue pen. You may use an HB pencil for any diagrams or graphs.
- Write your name, centre number and candidate number in the boxes at the top of the page.
- Write your answer to each question in the space provided.
- Do **not** use an erasable pen or correction fluid.
- Do **not** write on any bar codes.
- You should use a calculator where appropriate.
- You may use tracing paper.
- You must show all necessary working clearly.
- Give non-exact numerical answers correct to 3 significant figures, or 1 decimal place for angles in degrees, unless a different level of accuracy is specified in the question.
- For π , use either your calculator value or 3.142.

INFORMATION

- The total mark for this paper is 56.
- The number of marks for each question or part question is shown in brackets [].

This document has **12** pages. Any blank pages are indicated.



1 Write the number two million eight hundred and forty thousand three hundred and twenty-seven in figures.

..... [1]

2

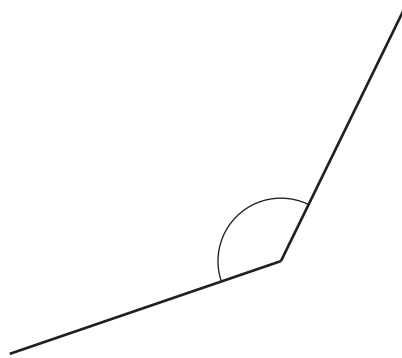

Write down the mathematical name of this type of angle.

..... [1]

3



(a) Measure the length of this line in millimetres.

..... mm [1]

(b) Draw a line perpendicular to this line.

[1]

- 4 In triangle PQR , $PR = 5$ cm and $QR = 4$ cm.

Using a ruler and compasses only, construct triangle PQR .

Leave in your construction arcs.

The side PQ has been drawn for you.



[2]

- 5 Write down a common multiple of 18 and 24.

..... [1]

- 6 Write 32 cm as a fraction of 2 m.
Give your answer in its simplest form.

..... [2]

- 7 The temperature, in $^{\circ}\text{C}$, is recorded at the same time in six cities.

London	Helsinki	Oslo	Paris	Madrid	Berlin
6	-2	-5	7	9	2

- (a) Which city has the coldest temperature?

..... [1]

- (b) What is the difference in temperature between Helsinki and Paris?

..... $^{\circ}\text{C}$ [1]

8

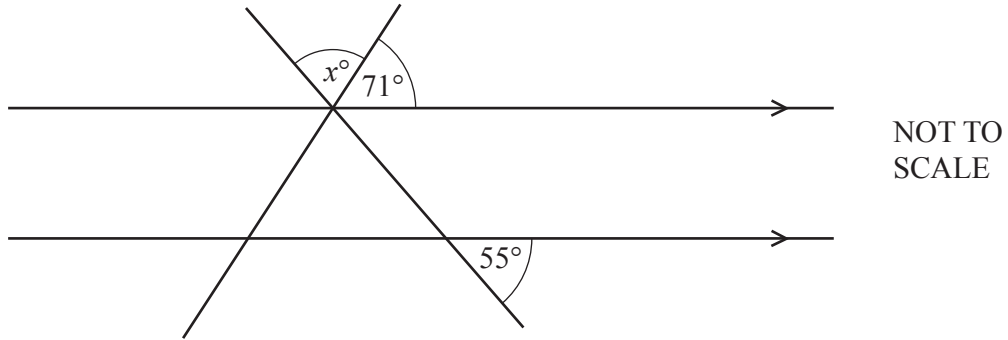

The diagram shows two straight lines intersecting two parallel lines.

Find the value of x .

$x = \dots\dots\dots$ [2]

9 Divide \$200 in the ratio 7 : 3.

\$ \dots\dots\dots , \$ \dots\dots\dots [2]

10 The birth weights, in kg, of 11 babies are recorded.

- 2.1 1.6 2.7 4.2 4.0 2.2 3.1 1.7 2.6 3.3 3.7

(a) Complete the stem-and-leaf diagram to show this information.

1	
2	
3	
4	

Key: 2|1 represents 2.1 kg

[2]

(b) Find the median.

\dots\dots\dots kg [1]

- 11 Victoria records the colour of each of 240 cars leaving a car park. Some of this information is shown in the pie chart.

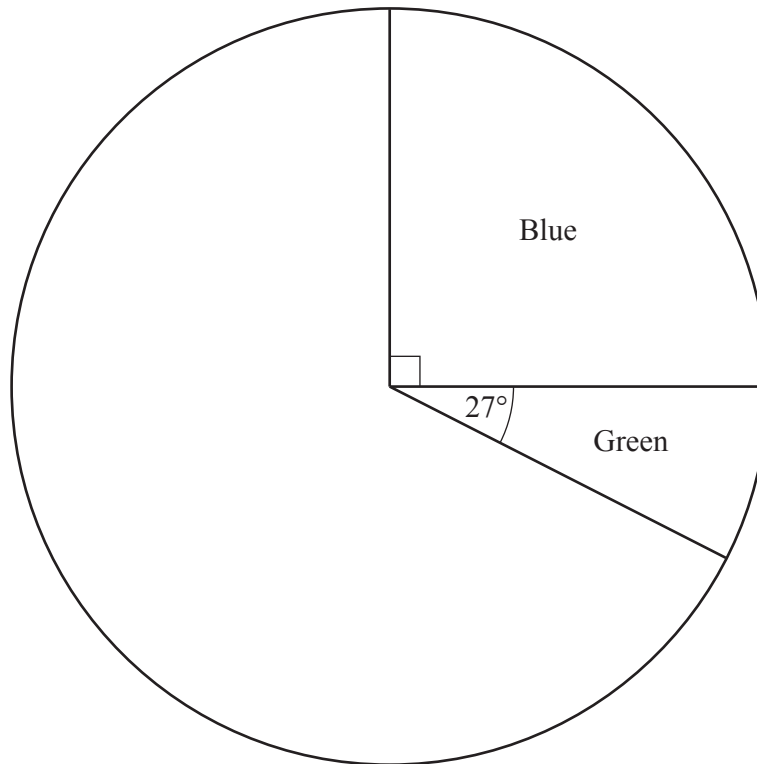

- (a) Show that 60 cars are blue.

[1]

- (b) The rest of the cars are either red or white.
110 cars are red.

Complete the pie chart to show this information.

[2]

- 12 The price of a computer is \$520.
This price is reduced by 15% in a sale.

Work out the sale price.

\$ [2]

- 13 **Without using a calculator**, work out $\frac{1}{3} + \frac{5}{6}$.

You must show all your working and give your answer as a mixed number in its simplest form.

..... [2]

- 14 Mario tests new cars.
The probability that a car is faulty is 0.04 .

(a) Find the probability that a car is not faulty.

..... [1]

(b) In one week Mario tests 850 cars.

Find the number of cars that are expected to be faulty.

..... [2]

- 15 A café sells 330 sandwiches.
This is $\frac{11}{14}$ of the sandwiches they make.

Work out the number of sandwiches the café makes.

..... [2]

- 16 (a) Complete the table of values for $y = \frac{5}{x}$.

x	-5	-4	-2.5	-2	-1		1	2	2.5	4	5
y	-1		-2	-2.5	-5		5	2.5	2		1

[2]

- (b) On the grid, draw the graph of $y = \frac{5}{x}$ for $-5 \leq x \leq -1$ and $1 \leq x \leq 5$.

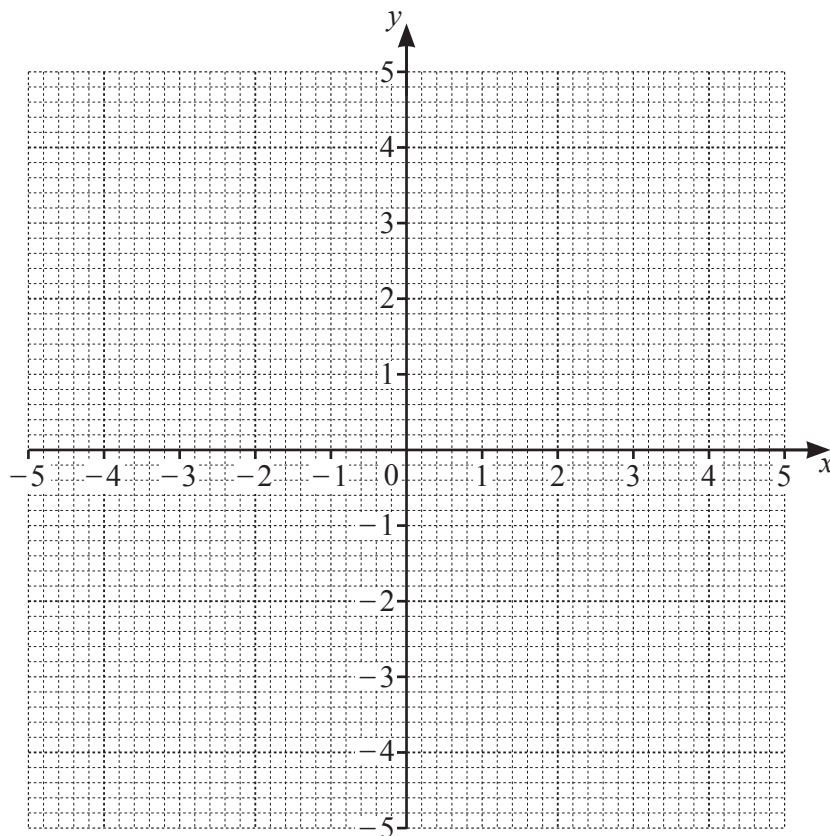

[4]

17 (a) 3, 9, 27, 81, ...

Write down the term to term rule for this sequence.

..... [1]

(b) 13, 17, 21, 25, ...

Find the n th term of this sequence.

..... [2]

18

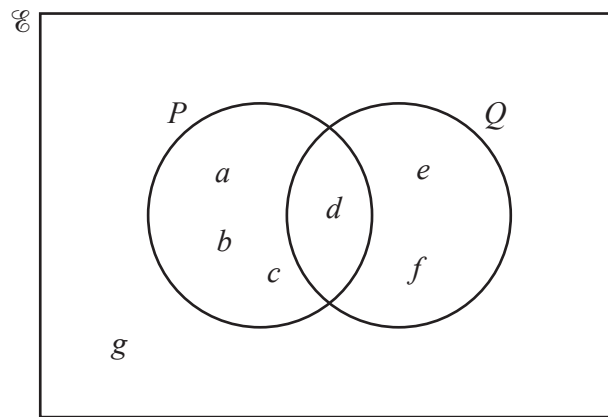

The Venn diagram shows the elements of the sets \mathcal{E} , P and Q .

Complete the statements.

(a) $P = \{ \dots \}$ [1]

(b) $n(P \cup Q) = \dots$ [1]

19 The bearing of A from B is 137° .

Find the bearing of B from A .

..... [2]

20 (a) Write 0.00273 in standard form.

..... [1]

(b) Sam has to answer this question.

Calculate 9306×4532 .

Give your answer in standard form correct to 3 significant figures.

Sam writes 42.1×10^6 as his answer to this question.

What two errors has Sam made?

Error 1

Error 2

[2]

21

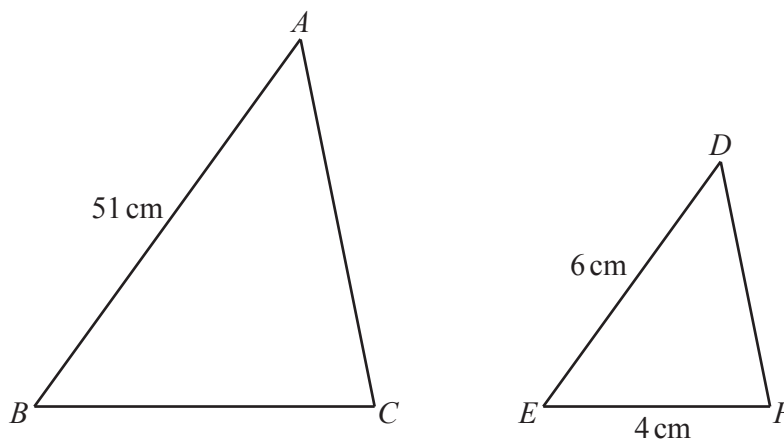

NOT TO
SCALE

Triangle ABC is mathematically similar to triangle DEF .

Find BC .

$BC =$ cm [2]

10

22

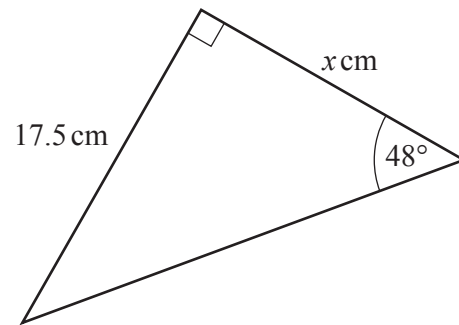
NOT TO
SCALE

The diagram shows a right-angled triangle.

Show that the value of x is 15.8, correct to 3 significant figures.

[3]

- 23 Natalie buys 4 tomato plants and 3 pepper plants for \$9.35 .
Samir buys 2 tomato plants and 11 pepper plants for \$16.55 .

Write down a pair of simultaneous equations and solve them to find the cost of one tomato plant and the cost of one pepper plant.

You must show all your working.

Tomato plant \$

Pepper plant \$ [5]

BLANK PAGE

Permission to reproduce items where third-party owned material protected by copyright is included has been sought and cleared where possible. Every reasonable effort has been made by the publisher (UCLES) to trace copyright holders, but if any items requiring clearance have unwittingly been included, the publisher will be pleased to make amends at the earliest possible opportunity.

To avoid the issue of disclosure of answer-related information to candidates, all copyright acknowledgements are reproduced online in the Cambridge Assessment International Education Copyright Acknowledgements Booklet. This is produced for each series of examinations and is freely available to download at www.cambridgeinternational.org after the live examination series.

Cambridge Assessment International Education is part of Cambridge Assessment. Cambridge Assessment is the brand name of the University of Cambridge Local Examinations Syndicate (UCLES), which is a department of the University of Cambridge.