



UNIVERSITY OF CAMBRIDGE INTERNATIONAL EXAMINATIONS  
International General Certificate of Secondary Education

**PHYSICAL SCIENCE**

**0652/12**

Paper 1 Multiple Choice

**October/November 2013**

**45 minutes**

Additional Materials: Multiple Choice Answer Sheet  
Soft clean eraser  
Soft pencil (type B or HB is recommended)



**READ THESE INSTRUCTIONS FIRST**

Write in soft pencil.

Do not use staples, paper clips, highlighters, glue or correction fluid.

Write your name, Centre number and candidate number on the Answer Sheet in the spaces provided unless this has been done for you.

**DO NOT WRITE IN ANY BARCODES.**

There are **forty** questions on this paper. Answer **all** questions. For each question there are four possible answers **A, B, C** and **D**.

Choose the **one** you consider correct and record your choice in **soft pencil** on the separate Answer Sheet.

**Read the instructions on the Answer Sheet very carefully.**

Each correct answer will score one mark. A mark will not be deducted for a wrong answer.

Any rough working should be done in this booklet.

A copy of the Periodic Table is printed on page 20.

Electronic calculators may be used.

This document consists of **17** printed pages and **3** blank pages.



1 The diagram shows the results of a chromatography experiment.

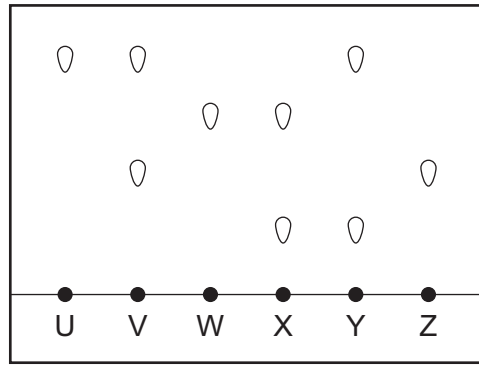

Which pair of substances are pure substances?

- A** U and X      **B** U and Z      **C** V and W      **D** W and Y

2 The diagrams show two different atoms.

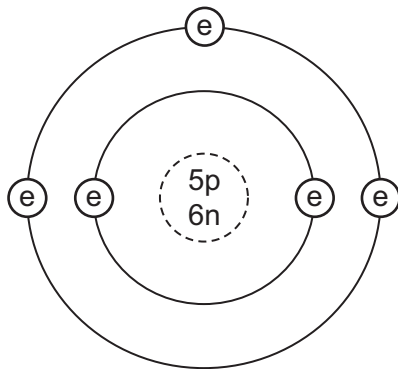

atom 1

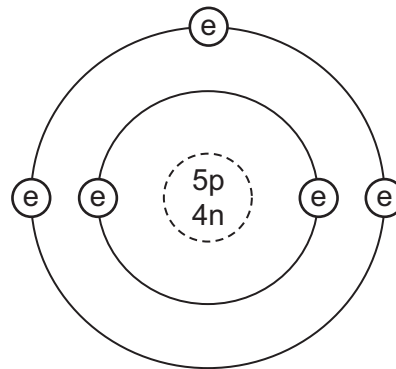

atom 2

key

e = electron

n = neutron

p = proton

Which statement is **not** correct?

- A** Atoms 1 and 2 are isotopes of the same element.  
**B** Atom 1 has the electronic configuration 2 3.  
**C** Atom 2 is boron.  
**D** The nucleon number of atom 1 is 9.

3

- 3 The diagram shows the bonding electrons in a covalent molecule.

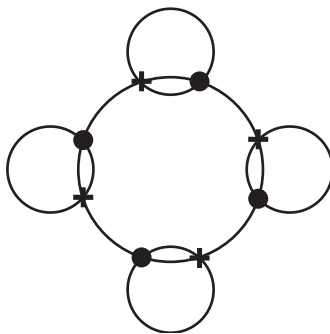

Which molecule is shown?

- A** chlorine  
**B** hydrogen chloride  
**C** methane  
**D** water
- 4 Which expression shows how the relative atomic mass ( $A_r$ ) of an element is calculated?
- A** mass of one atom of an element  $\times$  mass of one atom of C-12  
**B** mass of one atom of an element  $\times$  mass of one atom of C-12  $\times$  12  
**C**  $\frac{\text{mass of one atom of an element} \times 12}{\text{mass of one atom of C-12}}$   
**D**  $\frac{\text{mass of one atom of an element}}{\text{mass of one atom of C-12}} \times 12$
- 5 Which statements about catalysts are correct?
- 1 Catalysts increase the yield of the reaction.
  - 2 Catalysts increase the rate of the reaction.
  - 3 Catalysts are not used up in the reaction.
- A** 1 only  
**B** 2 only  
**C** 1 and 3  
**D** 2 and 3

4

- 6 Zinc reacts with steam to form zinc oxide and hydrogen.

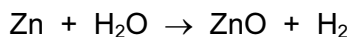

During the reaction, which substance is oxidised?

- A hydrogen
  - B water
  - C zinc
  - D zinc oxide
- 7 Which two substances react to form carbon dioxide?
- A dilute hydrochloric acid and calcium carbonate
  - B dilute hydrochloric acid and magnesium
  - C dilute hydrochloric acid and sodium oxide
  - D hydrogen peroxide and manganese(IV) oxide

- 8 The statements are about non-metals and their oxides.

Non-metals...X...electrons to form ions.

The oxides of non-metals are ...Y....

Which words complete the statements?

	X	Y
A	gain	acidic
B	gain	basic
C	lose	acidic
D	lose	basic

- 9 When solid calcium hydroxide and solid ammonium chloride are heated together a colourless gas is formed. The gas turns red litmus paper blue.

What is the gas?

- A ammonia
- B chlorine
- C hydrogen
- D sulfur dioxide

10 Which pair of elements combine together to form an ionic compound?

1	3															4	
																5	
2																	

- A 1 and 2      B 2 and 3      C 3 and 4      D 4 and 5

11 Transition metals are found in the middle of the Periodic Table.

Which properties are associated with transition metals?

	form coloured compounds	high density	low melting point
<b>A</b>	yes	yes	no
<b>B</b>	yes	no	yes
<b>C</b>	no	yes	yes
<b>D</b>	yes	yes	yes

12 The physical states of some elements at room temperature and the types of their oxides are shown.

Which element is a metal?

	physical state	type of oxide
<b>A</b>	gas	acidic
<b>B</b>	gas	basic
<b>C</b>	solid	acidic
<b>D</b>	solid	basic

13 Bauxite and haematite are important ores.

Which metals do the ores contain?

	bauxite	haematite
<b>A</b>	Al	Cu
<b>B</b>	Al	Fe
<b>C</b>	Fe	Cu
<b>D</b>	Cu	Al

14 The table shows some of the reactions of four metals and their oxides.

metal	metal with dilute hydrochloric acid	metal oxide with carbon
W	reacts	not readily reduced
X	no reaction	readily reduced
Y	reacts	reduced
Z	fast reaction	not reduced

What is the order of reactivity of these metals?

	most reactive	—————→			least reactive
<b>A</b>	Z	W	Y	X	
<b>B</b>	Z	Y	W	X	
<b>C</b>	X	W	Y	Z	
<b>D</b>	X	Y	W	Z	

15 Why are some iron objects galvanised?

- A** to increase the density
- B** to lubricate the iron
- C** to produce an alloy
- D** to stop corrosion

16 Which type of reaction occurs when calcium oxide (lime) is manufactured from calcium carbonate (limestone)?

- A combustion
- B decomposition
- C neutralisation
- D oxidation

17 Which row shows the correct uses of the fractions obtained from petroleum?

	petrol	paraffin	lubricating fraction	bitumen
<b>A</b>	fuel for diesel engines	fuel for oil stoves	waxes and polishes	making roads
<b>B</b>	fuel for cars	fuel for oil stoves	waxes and polishes	making roads
<b>C</b>	fuel for cars	fuel for diesel engines	waxes and polishes	making roads
<b>D</b>	fuel for cars	fuel for oil stoves	fuel for diesel engines	waxed and polishes

18 Which statements about the alkane homologous series are correct?

- 1 They burn in air to produce carbon dioxide and water.
- 2 They decolourise bromine water.
- 3 Their boiling point increases as the number of carbon atoms increases.
- 4 They contain carbon to carbon double bonds.

- A** 1, 2 and 3      **B** 1 and 2      **C** 1 and 3      **D** 2 and 4

19 The word equation shows a reaction of ethene.



What type of reaction occurs and what is X?

	type of reaction	X
<b>A</b>	addition	hydrogen
<b>B</b>	addition	steam
<b>C</b>	reduction	hydrogen
<b>D</b>	reduction	steam

20 The combustion of ethanol can be investigated by using a spirit burner.

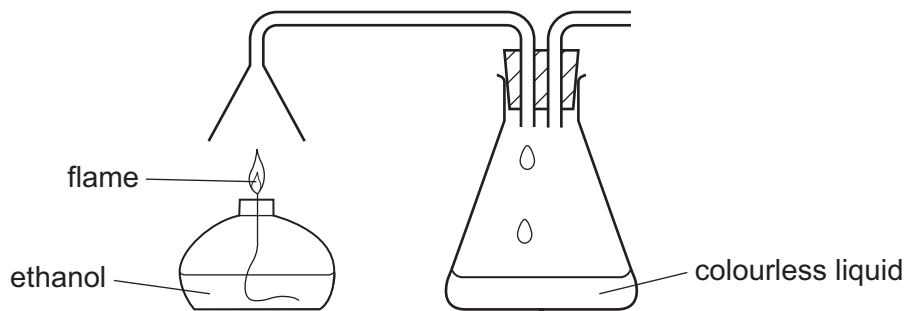

What is the colourless liquid collected in the flask?

- A carbon dioxide
  - B ethanoic acid
  - C ethanol
  - D water
- 21 Diagram 1 shows a measuring cylinder containing water. When a stone is placed in the water, the level rises to the position shown in diagram 2.

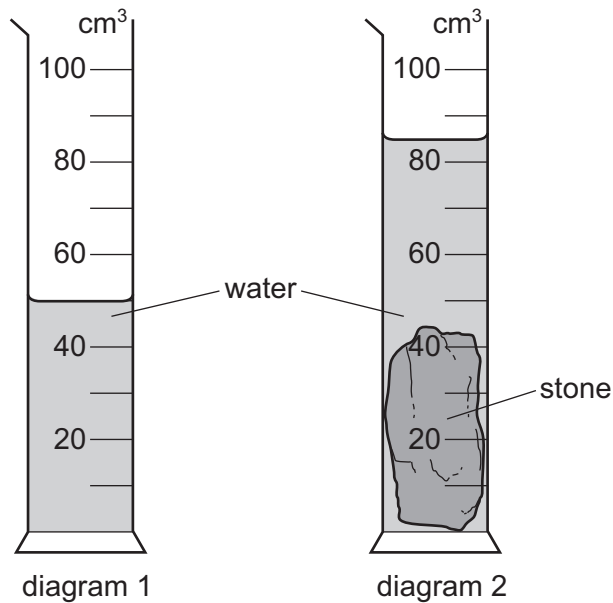

What is the volume of the stone?

- A  $35\text{ cm}^3$
- B  $40\text{ cm}^3$
- C  $45\text{ cm}^3$
- D  $85\text{ cm}^3$





24 Which quantity has the same unit as force?

- A density
- B energy
- C mass
- D weight

25 A scientist calculates the density of a piece of metal.

How does he calculate the density?

- A He divides the mass of the metal by its volume.
- B He divides the volume of the metal by its mass.
- C He divides the volume of the metal by its weight.
- D He divides the weight of the metal by its volume.

26 The diagram shows a man in a small boat.



Why does the boat become less stable when the man stands up?

- A The centre of mass of the man and the boat is higher.
  - B The centre of mass of the man and the boat is lower.
  - C The total mass of the man and the boat is greater.
  - D The total mass of the man and the boat is less.
- 27 Which source of energy involves a regrouping of atoms?
- A fuel energy
  - B geothermal energy
  - C hydroelectric energy
  - D nuclear energy

28 A pole-vaulter runs up to a jump with his pole straight. He puts one end of the pole on the ground and the pole bends as he jumps.

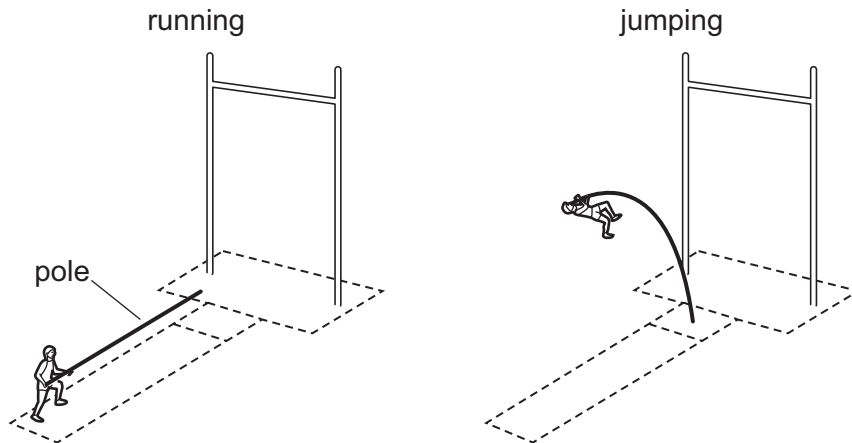

Which form of energy is stored in the pole because it is bent?

- A chemical
- B gravitational
- C motion
- D strain

29 A liquid-in-glass thermometer can be used to measure temperatures from 0°C to 100°C.

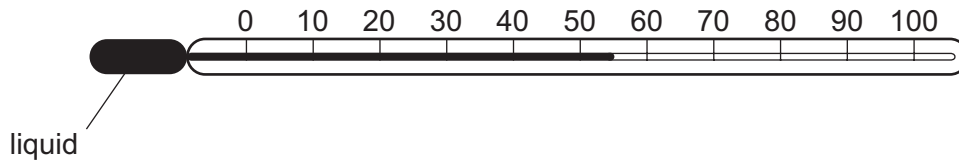

Which row describes the boiling point of the liquid and the effect of heating the liquid?

	boiling point of liquid	effect of heating the liquid
A	higher than 100°C	contracts
B	higher than 100°C	expands
C	lower than 100°C	contracts
D	lower than 100°C	expands

30 A girl sits by a camp fire. She holds a piece of wood with one end in the fire.

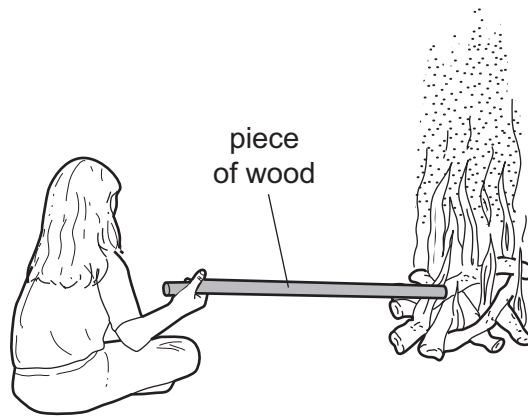

Heat from the fire reaches her hand.

How does heat from the fire reach her hand?

- A conduction, convection and radiation
- B conduction only
- C convection only
- D radiation only

31 A cork moves up and down in water as a wave passes.

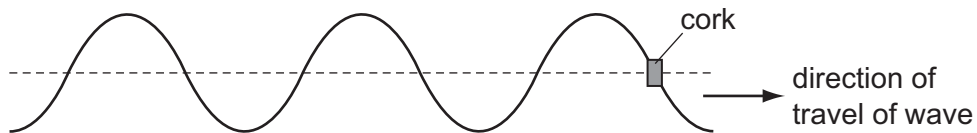

The cork moves up and down 3 times in 12 seconds.

What is the frequency of the wave?

- A 0.25Hz
- B 3.0Hz
- C 4.0Hz
- D 36Hz

- 32 An object is placed 0.16 m from a plane mirror. A ray of light from the object strikes the mirror at an angle of incidence of  $35^\circ$ .

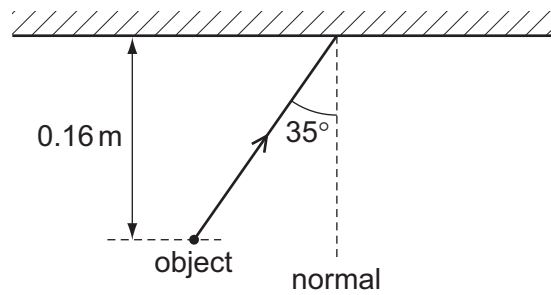

How far is the image from the object and what is the angle between the normal and the reflected ray?

	distance of the image from the object / m	angle between the normal and the reflected ray
<b>A</b>	0.16	$35^\circ$
<b>B</b>	0.16	$55^\circ$
<b>C</b>	0.32	$35^\circ$
<b>D</b>	0.32	$55^\circ$

33 One end of a soft iron bar is held over a dish of iron filings and the other end is placed in contact with a magnet. The magnet is then removed.

Which pair of diagrams show the magnetic poles in the soft iron bar and what happens when the magnet is removed from the soft iron bar?

	magnet and soft iron bar in contact	magnet removed
<b>A</b>		
<b>B</b>		
<b>C</b>		
<b>D</b>		

34 Which quantities can be measured using only a voltmeter?

- A current and e.m.f.
- B current and resistance
- C e.m.f. and potential difference
- D potential difference and resistance

35 In the circuit below, one of the lamps breaks, causing all the other lamps to go out.

Which lamp breaks?

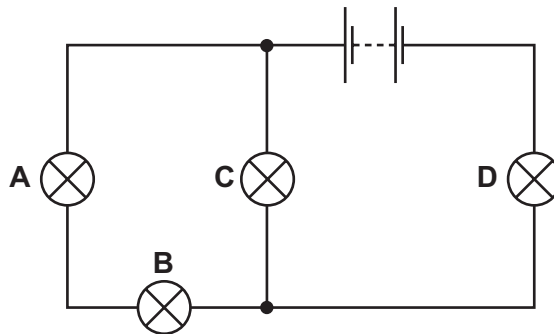

36 Four ammeters P, Q, R and S are connected in series in the circuit shown.

Two of the ammeters give an accurate reading and two give an inaccurate reading.

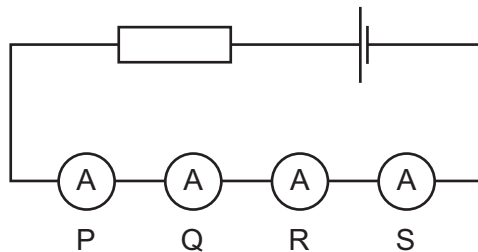

The readings on the ammeters are:

P 3.3A

Q 3.1A

R 3.1A

S 2.9A

Which two ammeters give inaccurate readings?

- A** P and Q      **B** P and S      **C** Q and R      **D** R and S

37 It is dangerous for electric sockets and wall switches to be fitted in a room with a hot shower.

Why is this?

- A** In a steamy atmosphere you may not be able to see a switch.  
**B** The switch contacts might become rusty and not work.  
**C** The warmth of the atmosphere might damage the switch insulation.  
**D** Water conducts electricity, so a damp switch may be 'live' if touched.

- 38 An evacuated glass bulb contains a small tungsten filament T and a metal plate P.

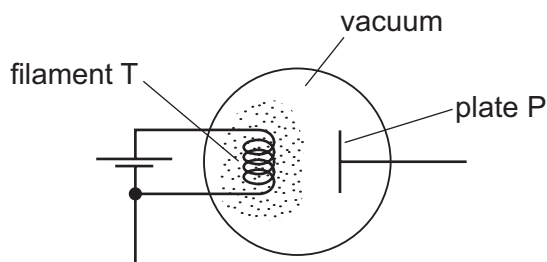

Filament T is heated and particles are emitted from it by thermionic emission.

The particles emitted from filament T are attracted towards plate P.

What is the sign of the charge on the particles and what is the sign of the charge on plate P?

	sign of charge on particles	sign of charge on plate P
<b>A</b>	negative	negative
<b>B</b>	negative	positive
<b>C</b>	positive	negative
<b>D</b>	positive	positive

- 39 A radioactive nucleus emits a beta-particle.

What happens to the nucleus?

- A** Its nucleon number decreases.  
**B** Its nucleon number stays the same.  
**C** Its proton number decreases.  
**D** Its proton number stays the same.
- 40 A nuclide of oxygen can be represented by the symbol  $^{17}_8\text{O}$ .

In a neutral atom of  $^{17}_8\text{O}$ , how many electrons, neutrons and protons are there?

	electrons	neutrons	protons
<b>A</b>	8	9	8
<b>B</b>	8	17	8
<b>C</b>	8	17	9
<b>D</b>	9	8	9









