



Cambridge International Examinations
Cambridge International General Certificate of Secondary Education

PHYSICAL SCIENCE

0652/12

Paper 1 Multiple Choice

October/November 2018

45 minutes

Additional Materials: Multiple Choice Answer Sheet
Soft clean eraser
Soft pencil (type B or HB is recommended)

* 1 2 1 0 9 8 2 7 2 8 *



READ THESE INSTRUCTIONS FIRST

Write in soft pencil.

Do not use staples, paper clips, glue or correction fluid.

Write your name, Centre number and candidate number on the Answer Sheet in the spaces provided unless this has been done for you.

DO NOT WRITE IN ANY BARCODES.

There are **forty** questions on this paper. Answer **all** questions. For each question there are four possible answers **A, B, C** and **D**.

Choose the **one** you consider correct and record your choice in **soft pencil** on the separate Answer Sheet.

Read the instructions on the Answer Sheet very carefully.

Each correct answer will score one mark. A mark will not be deducted for a wrong answer.

Any rough working should be done in this booklet.

A copy of the Periodic Table is printed on page 20.

Electronic calculators may be used.

This document consists of **17** printed pages and **3** blank pages.

- 1 When smoke particles collide with molecules in the air, the smoke particles move randomly.

How is the movement of the smoke particles described?

- A Brownian motion
 B condensation
 C diffusion
 D evaporation
- 2 The diagram shows a chromatogram obtained using five felt-tip pens.

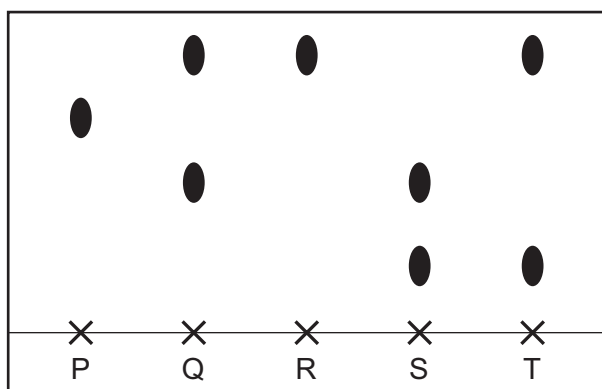

Which statement about the pens is **not** correct?

- A One of the dyes is found in three pens.
 B Pen R contains a mixture of dyes.
 C Three pens contain two dyes.
 D Two pens contain only one dye.
- 3 The table shows the number of protons, neutrons and electrons in some particles.

particle	protons	neutrons	electrons
W	11	12	11
X	12	12	10
Y	10	13	11
Z	11	13	11

Which particles are isotopes of the same element?

- A W and X B W and Y C W and Z D Y and Z

- 4 Compound J contains the elements Y and Z.

The diagram shows the outer-shell electron arrangement of compound J.

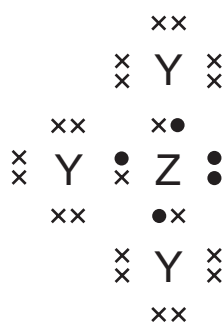

Which type of compound is J?

- A** alloy
- B** covalent
- C** ionic
- D** macromolecule
- 5 Which statement describes the structure of diamond?
- A** a covalent solid that has atoms arranged in a hexagonal pattern
- B** a covalent solid that has atoms arranged in a tetrahedral pattern
- C** an ionic solid that has atoms arranged in a hexagonal pattern
- D** an ionic solid that has atoms arranged in a tetrahedral pattern
- 6 Hydrogen reacts with oxygen to form water. The word equation is shown.

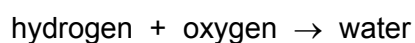

What is the symbol equation for this reaction?

- A** $\text{H}_2 + \text{O} \rightarrow \text{H}_2\text{O}$
- B** $\text{H}_2 + \text{O}_2 \rightarrow \text{H}_2\text{O}$
- C** $\text{H}_2 + \text{O}_2 \rightarrow \text{H}_2\text{O}_2$
- D** $2\text{H}_2 + \text{O}_2 \rightarrow 2\text{H}_2\text{O}$

7 The formulae of three substances are shown.

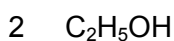

Which substances have a relative molecular mass of 46?

- A** 1, 2 and 3 **B** 1 and 2 only **C** 1 only **D** 2 only

8 Anhydrous copper(II) sulfate is placed in a test-tube.

When water is added to the test-tube, the temperature changes from 17°C to 27°C .

Which type of reaction takes place?

- A** addition
B endothermic
C exothermic
D oxidation

9 Which reaction is an oxidation?

- A** $2\text{SO}_2 + \text{O}_2 \rightarrow 2\text{SO}_3$
B $\text{NaOH} + \text{HCl} \rightarrow \text{NaCl} + \text{H}_2\text{O}$
C $\text{CaCO}_3 \rightarrow \text{CaO} + \text{CO}_2$
D $\text{NH}_3 + \text{HCl} \rightarrow \text{NH}_4\text{Cl}$

10 The chart shows the colour of Universal Indicator at different pH values.

colour	red			orange			green			blue		violet		
pH	1	2	3	4	5	6	7	8	9	10	11	12	13	14

A solution of lemon juice is only slightly acidic.

Which colour does Universal Indicator give with this solution?

- A** blue
B orange
C red
D violet

11 The statements are about non-metals and their oxides.

Non-metals...X...electrons to form ions.

The oxides of non-metals are ...Y....

Which words complete the statements?

	X	Y
A	gain	acidic
B	gain	basic
C	lose	acidic
D	lose	basic

12 The results of tests on an aqueous solution, X, are shown.

reagent	result
aqueous sodium hydroxide	green precipitate insoluble in excess
aqueous silver nitrate acidified with dilute nitric acid	white precipitate

What is X?

- A** iron(II) chloride
- B** iron(II) sulfate
- C** iron(III) chloride
- D** iron(III) sulfate

13 Which statement about trends down groups in the Periodic Table is correct?

- A** The Group I elements become less reactive with water.
- B** The Group I elements show an increase in melting point.
- C** The Group VII elements become darker in colour.
- D** The Group VII elements show an increased ability to displace halide ions.

14 The noble gases make up a group in the Periodic Table.

Which statements describe the properties of noble gases?

- 1 They have full outer shells.
- 2 They are diatomic.
- 3 They are very unreactive.

A 1, 2 and 3 **B** 1 and 2 only **C** 1 and 3 only **D** 2 and 3 only

15 The diagram shows the properties of four substances.

Which one is magnesium?

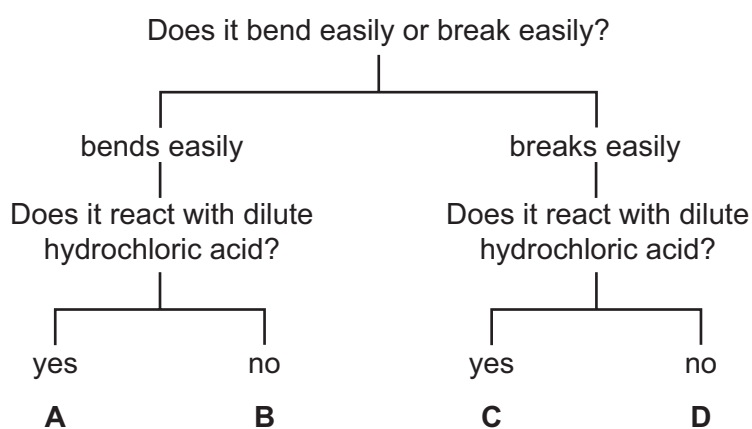

16 Which gas makes up approximately 78% of clean air?

- A** argon
- B** carbon dioxide
- C** oxygen
- D** nitrogen

17 Which statement about calcium oxide (lime) is correct?

- A** It is manufactured by the action of heat on hematite.
- B** It is manufactured by the action of heat on limestone.
- C** It is used to increase the acidity of soils.
- D** It is used to neutralise alkaline industrial waste.

- 18 Which row describes the correct use for a fraction obtained from petroleum by fractional distillation?

	fraction	use
A	bitumen	making waxes and polishes
B	diesel	fuel for oil stoves
C	lubricating	making roads
D	paraffin	aircraft fuel

- 19 What is **not** a property of the members of a homologous series?

- A** They have similar chemical properties.
B They have successive members differing by CH_2 .
C They have the same functional group.
D They have the same physical properties.

- 20 Which compound is the monomer used to make poly(ethene)?

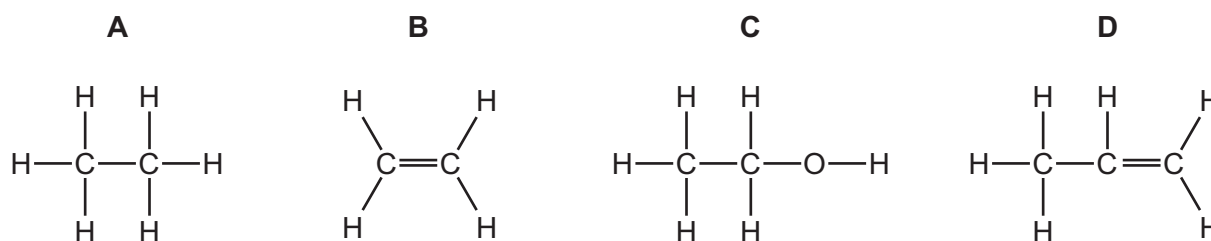

- 21 A girl uses a rule to measure the length of a metal rod. The end of the rule is damaged so she places one end of the rod at the 1 cm mark as shown.

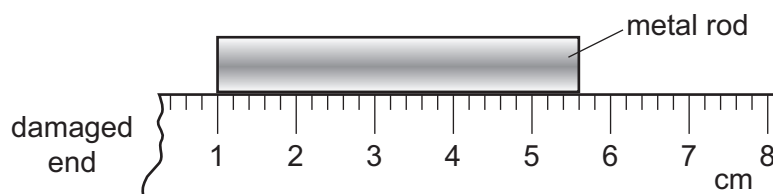

How long is the metal rod?

- A** 43 mm **B** 46 mm **C** 53 mm **D** 56 mm

22 The diagram shows the speed-time graph for a vehicle. Two sections are labelled P and Q.

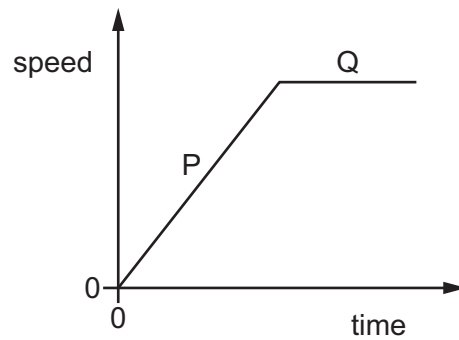

Which row describes the motion of the vehicle?

	section P	section Q
A	moving with changing speed	at rest
B	moving with changing speed	moving with constant speed
C	moving with constant speed	at rest
D	moving with constant speed	moving with constant speed

23 Which quantity has the same unit as force?

- A** current
- B** energy
- C** speed
- D** weight

24 The diagram shows a man in a small boat.



Why does the boat become less stable when the man stands up?

- A The centre of mass of the man and the boat is higher.
 - B The centre of mass of the man and the boat is lower.
 - C The total mass of the man and the boat is greater.
 - D The total mass of the man and the boat is less.
- 25 A student lifts a box from the floor to a shelf. The size of the force used to lift the box affects the total amount of work done by the student.

On which other quantity does the work done depend?

- A the height of the shelf above the floor
 - B the surface area of the box
 - C the time taken to lift the box
 - D the volume of the box
- 26 Which form of energy is stored in a stretched spring because it is stretched?
- A chemical
 - B electrical
 - C light
 - D strain

27 A chemical process causes energy to be released.

Which type of power station makes use of this type of process?

- A a gas-fired power station
- B a geothermal power station
- C a hydroelectric power station
- D a nuclear power station

28 A solid substance is at its melting point.

It is heated until it is completely melted.

As the substance melts, what is happening to its energy, and what is happening to its temperature?

	energy of the substance	temperature of the substance
A	constant	constant
B	constant	decreasing
C	increasing	constant
D	increasing	decreasing

- 29 The diagram shows a heater in a box that contains air. A thermometer is fixed in the box. The thermometer bulb is in the position shown.

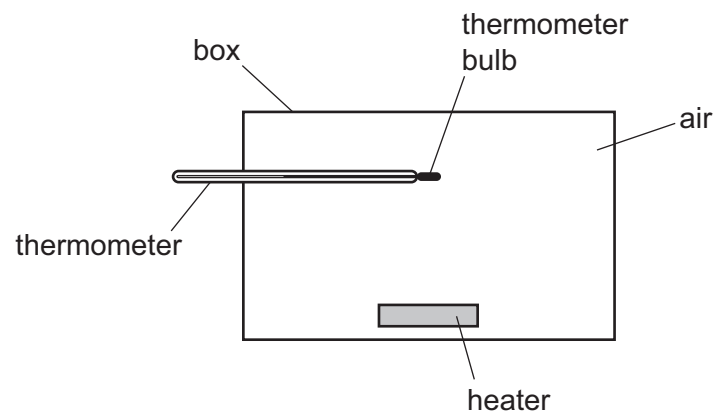

Which row shows how thermal energy from the heater reaches the thermometer bulb?

	conduction	convection	radiation
A	✓	✓	x
B	✓	x	✓
C	x	✓	✓
D	x	x	✓

- 30 The diagram shows a ray of light passing into a glass block.

Which labelled angle is the angle of refraction?

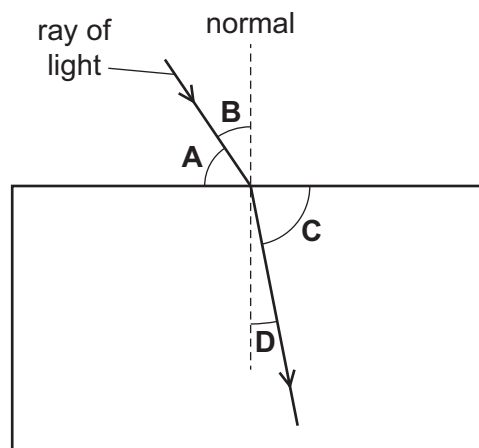

31 Which of these is part of the electromagnetic spectrum?

- A alpha radiation from a radioactive source
- B cathode rays in an oscilloscope
- C infra-red radiation from a candle flame
- D sound waves from a bell

32 A vibrating object produces waves of different frequencies in air.

Which frequency is a sound wave that someone with normal hearing is able to hear?

- A 2.5 Hz
- B 1000 Hz
- C 25 000 Hz
- D 100 000 Hz

33 Why is iron a suitable material for the core of an electromagnet?

- A It is a good conductor of electricity.
- B It is a poor conductor of electricity.
- C It loses its magnetism when the current is switched off.
- D It stays magnetised when the current is switched off.

34 Which graph represents the V/I characteristic of a resistor with constant resistance?

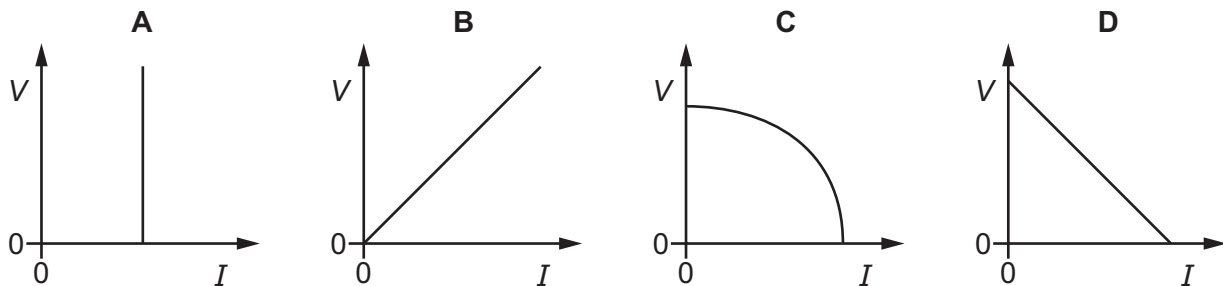

35 The diagrams show 2Ω resistors in different arrangements.

Which arrangement has the smallest total resistance?

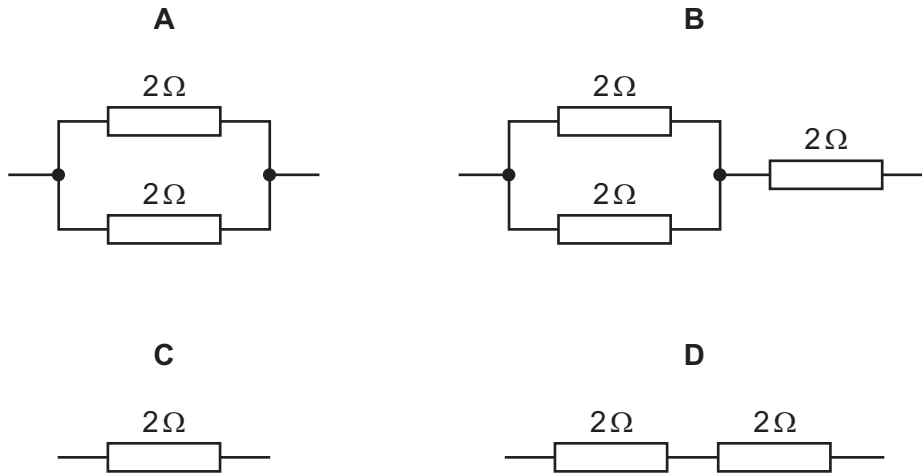

36 A student connects a number of electrical appliances to the same electric socket through two adaptors.

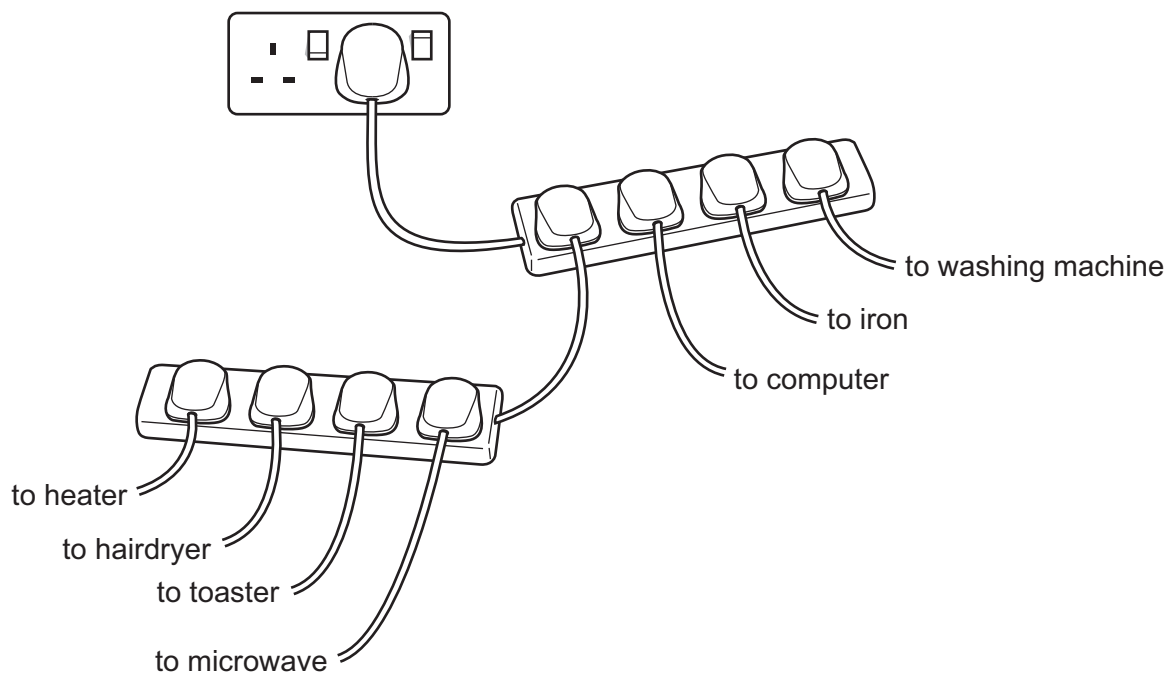

What is the main hazard produced by this arrangement?

- A a fire caused by overheating wires
- B a person receiving an electric shock
- C an appliance overheating
- D the appliances sharing the voltage available

37 The diagrams show two forces acting on the coil of an electric motor.

In which diagram do the two forces cause the coil to rotate?

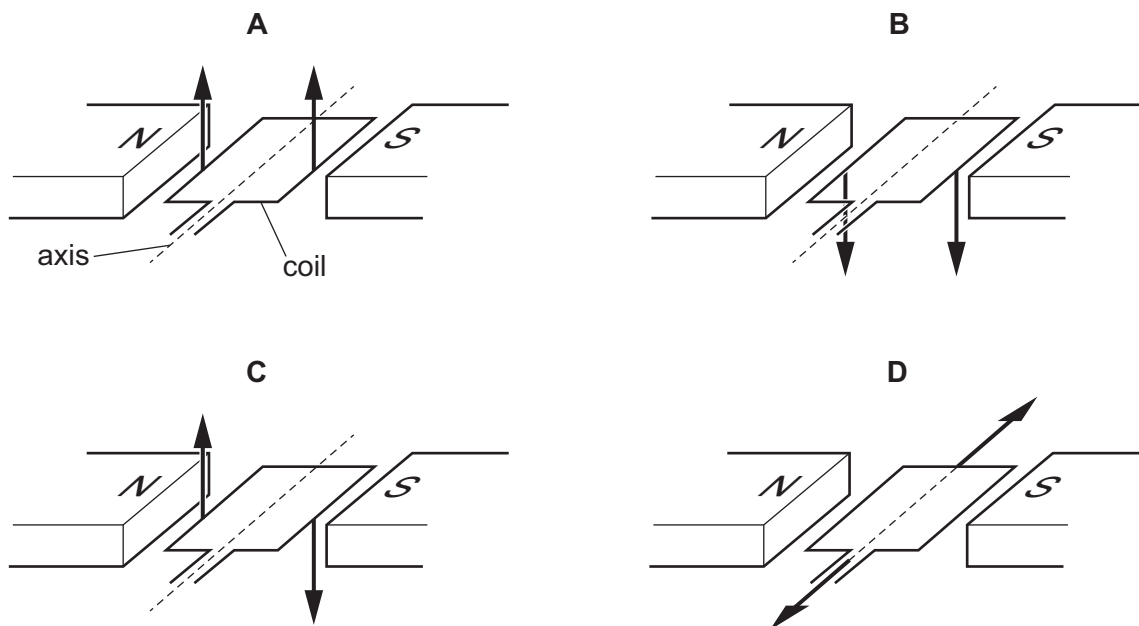

38 The diagram shows a cathode-ray tube. The tube is not working properly.

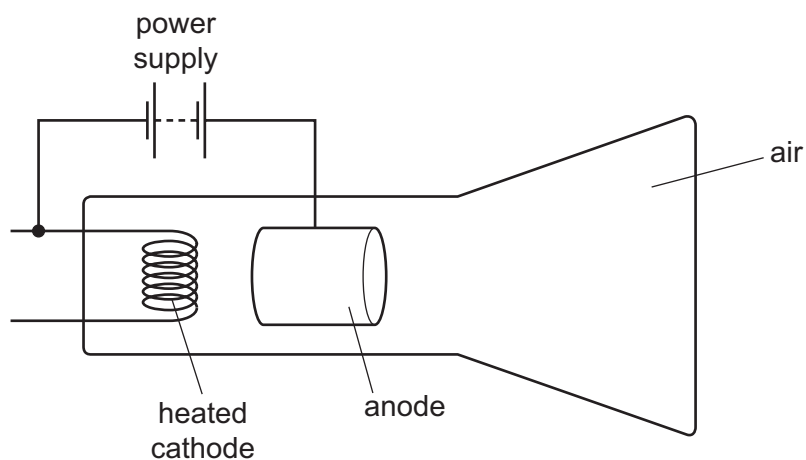

Which change should be made to make the tube work properly to produce cathode rays?

- A Heat the anode instead of the cathode.
- B Reverse the connections of the power supply.
- C Use an a.c. power supply instead of a d.c. power supply.
- D Use a vacuum in the tube instead of air.

39 A radioactive source is placed very close to a detector that is connected to a counter.

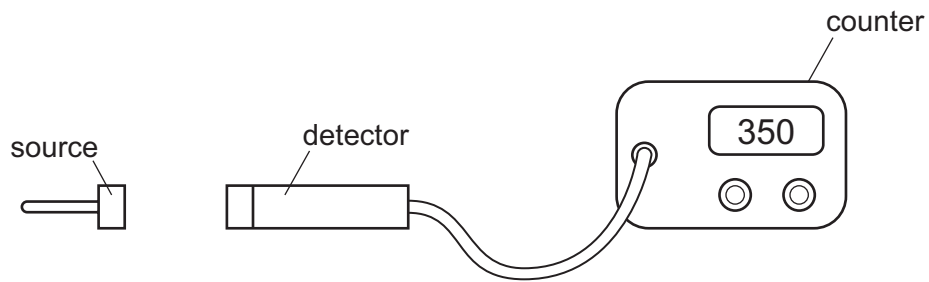

The reading on the counter shows how much radiation is reaching the detector.

The table shows the original reading and the readings when the radiation is travelling perpendicular to an electric field or a magnetic field.

	original reading	reading with an electric field	reading with a magnetic field
detector reading / counts per minute	350	350	350

Which types of radiation are emitted by the source?

- A alpha-particles and beta-particles
- B alpha-particles only
- C beta-particles only
- D gamma-rays only

40 The graph shows the decay curve for one particular radioactive isotope.

The count rate is corrected to remove the effect of background radiation.

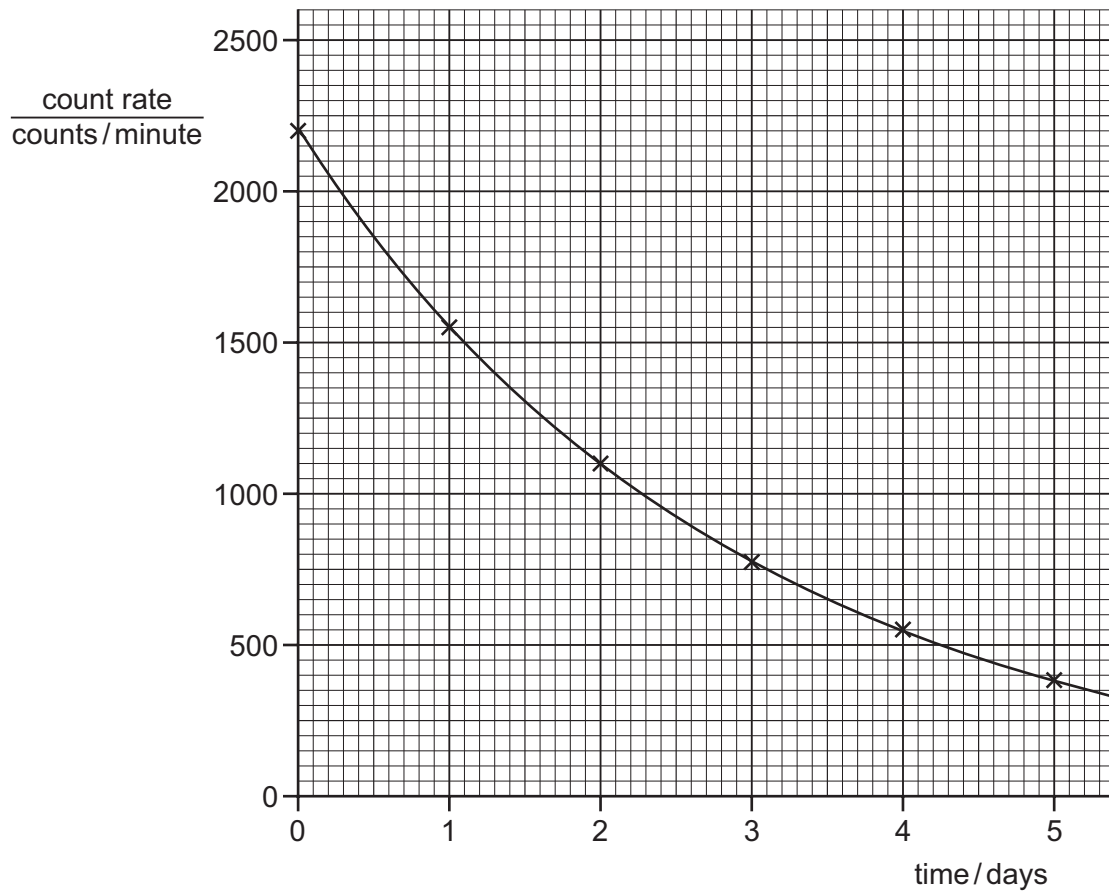

What is the half-life of this isotope?

- A** 1.0 day **B** 1.5 days **C** 2.0 days **D** 2.5 days

BLANK PAGE

BLANK PAGE

BLANK PAGE

Permission to reproduce items where third-party owned material protected by copyright is included has been sought and cleared where possible. Every reasonable effort has been made by the publisher (UCLES) to trace copyright holders, but if any items requiring clearance have unwittingly been included, the publisher will be pleased to make amends at the earliest possible opportunity.

To avoid the issue of disclosure of answer-related information to candidates, all copyright acknowledgements are reproduced online in the Cambridge International Examinations Copyright Acknowledgements Booklet. This is produced for each series of examinations and is freely available to download at www.cie.org.uk after the live examination series.

Cambridge International Examinations is part of the Cambridge Assessment Group. Cambridge Assessment is the brand name of University of Cambridge Local Examinations Syndicate (UCLES), which is itself a department of the University of Cambridge.

The Periodic Table of Elements

		Group															
I	II											III	IV	V	VI	VII	VIII
3 Li lithium 7	4 Be beryllium 9	<div style="border: 1px solid black; padding: 5px; text-align: center;"> Key atomic number atomic symbol name relative atomic mass </div>										5 B boron 11	6 C carbon 12	7 N nitrogen 14	8 O oxygen 16	9 F fluorine 19	10 Ne neon 20
11 Na sodium 23	12 Mg magnesium 24											1 H hydrogen 1	13 Al aluminium 27	14 Si silicon 28	15 P phosphorus 31	16 S sulfur 32	17 Cl chlorine 35.5
19 K potassium 39	20 Ca calcium 40	21 Sc scandium 45	22 Ti titanium 48	23 V vanadium 51	24 Cr chromium 52	25 Mn manganese 55	26 Fe iron 56	27 Co cobalt 59	28 Ni nickel 59	29 Cu copper 64	30 Zn zinc 65	31 Ga gallium 70	32 Ge germanium 73	33 As arsenic 75	34 Se selenium 79	35 Br bromine 80	36 Kr krypton 84
37 Rb rubidium 85	38 Sr strontium 88	39 Y yttrium 89	40 Zr zirconium 91	41 Nb niobium 93	42 Mo molybdenum 96	43 Tc technetium —	44 Ru ruthenium 101	45 Rh rhodium 103	46 Pd palladium 106	47 Ag silver 108	48 Cd cadmium 112	49 In indium 115	50 Sn tin 119	51 Sb antimony 122	52 Te tellurium 128	53 I iodine 127	54 Xe xenon 131
55 Cs caesium 133	56 Ba barium 137	57–71 lanthanoids	72 Hf hafnium 178	73 Ta tantalum 181	74 W tungsten 184	75 Re rhenium 186	76 Os osmium 190	77 Ir iridium 192	78 Pt platinum 195	79 Au gold 197	80 Hg mercury 201	81 Tl thallium 204	82 Pb lead 207	83 Bi bismuth 209	84 Po polonium —	85 At astatine —	86 Rn radon —
87 Fr francium —	88 Ra radium —	89–103 actinoids	104 Rf rutherfordium —	105 Db dubnium —	106 Sg seaborgium —	107 Bh bohrium —	108 Hs hassium —	109 Mt meitnerium —	110 Ds darmstadtium —	111 Rg roentgenium —	112 Cn copernicium —	114 Fl flerovium —	116 Lv livermorium —	—	—	—	—

lanthanoids	57 La lanthanum 139	58 Ce cerium 140	59 Pr praseodymium 141	60 Nd neodymium 144	61 Pm promethium —	62 Sm samarium 150	63 Eu europium 152	64 Gd gadolinium 157	65 Tb terbium 159	66 Dy dysprosium 163	67 Ho holmium 165	68 Er erbium 167	69 Tm thulium 169	70 Yb ytterbium 173	71 Lu lutetium 175
actinoids	89 Ac actinium —	90 Th thorium 232	91 Pa protactinium 231	92 U uranium 238	93 Np neptunium —	94 Pu plutonium —	95 Am americium —	96 Cm curium —	97 Bk berkelium —	98 Cf californium —	99 Es einsteinium —	100 Fm fermium —	101 Md mendelevium —	102 No nobelium —	103 Lr lawrencium —

The volume of one mole of any gas is 24 dm³ at room temperature and pressure (r.t.p.).