



Cambridge IGCSE™

PHYSICAL SCIENCE**0652/52**

Paper 5 Practical Test

October/November 2022

CONFIDENTIAL INSTRUCTIONS

This document gives details of how to prepare for and administer the practical exam.

The information in this document and the identity of any materials supplied by Cambridge International are confidential and must NOT reach candidates either directly or indirectly.

The supervisor must complete the report at the end of this document and return it with the scripts.

INSTRUCTIONS

- If you have any queries regarding these confidential instructions, contact Cambridge International stating the centre number, the syllabus and component number and the nature of the query.
email info@cambridgeinternational.org
phone +44 1223 553554

This document has **8** pages.

General information about practical exams

Centres must follow the guidance on science practical exams given in the *Cambridge Handbook*.

Safety

Supervisors must follow national and local regulations relating to safety and first aid.

Only those procedures described in the question paper should be attempted.

Supervisors must inform candidates that materials and apparatus used in the exam should be treated with caution. Suitable eye protection should be used where necessary.

The following hazard codes are used in these confidential instructions, where relevant:

C	corrosive	MH	moderate hazard
HH	health hazard	T	acutely toxic
F	flammable	O	oxidising
N	hazardous to the aquatic environment		

Hazard data sheets relating to substances used in this exam should be available from your chemical supplier.

Before the exam

- The packets containing the question papers must **not** be opened before the exam.
- It is assumed that standard school laboratory facilities, as indicated in the *Guide to Planning Practical Science*, will be available.
- Spare materials and apparatus for the tasks set must be available for candidates, if required.

During the exam

- It must be made clear to candidates at the start of the exam that they may request spare materials and apparatus for the tasks set.
- Where specified, the supervisor **must** perform the experiments and record the results as instructed. This must be done **out of sight** of the candidates, using the same materials and apparatus as the candidates.
- Any assistance provided to candidates must be recorded in the supervisor's report.
- If any materials or apparatus need to be replaced, for example, in the event of breakage or loss, this must be recorded in the supervisor's report.

After the exam

- The supervisor must complete a report for each practical session held and each laboratory used.
- Each packet of scripts returned to Cambridge International must contain the following items:
 - the scripts of the candidates specified on the bar code label provided
 - the supervisor's results relevant to these candidates
 - the supervisor's reports relevant to these candidates
 - seating plans for each practical session, referring to each candidate by candidate number
 - the attendance register.

Specific information for this practical exam

During the exam, the supervisor (NOT the invigilator) must do the experiments in Questions 1, 2 and 3 and record the results on a spare copy of the question paper, clearly labelled 'supervisor's results'.

Apparatus and chemicals for Question 1

Each candidate will require:

- [MH] (i) 8g sodium carbonate, $\text{Na}_2\text{CO}_3 \cdot 10\text{H}_2\text{O}$ labelled **sodium carbonate**
- (ii) an evaporating basin
- (iii) a burner and a means to light it
- (iv) a heatproof mat
- (v) a tripod
- (vi) a gauze
- (vii) access to a balance to ± 0.1 g
- (viii) tongs.

Apparatus and chemicals for Question 2

Each candidate will require:

- (i) 10 cm³ 1 mol dm⁻³ hydrochloric acid in a small beaker labelled **solution A**
- [C] (ii) 10 cm³ 1 mol dm⁻³ aqueous sodium hydroxide in a small beaker labelled **solution B**
- [MH][N] (iii) 10 cm³ 1 mol dm⁻³ aqueous ammonia in a small beaker labelled **solution C**
- [C] (iv) access to nitric acid, approximately 1 mol dm⁻³ and a dropping pipette
- (v) access to aqueous barium nitrate, approximately 0.1 mol dm⁻³ and a dropping pipette
- [MH][N] (vi) access to aqueous silver nitrate, approximately 0.05 mol dm⁻³ and a dropping pipette
- [C][MH][N] (vii) 5 cm³ 1 mol dm⁻³ aqueous copper sulfate
- (viii) universal indicator solution
- (ix) 11 test-tubes and a means to support them. See note 1
- (x) a small beaker with the end of a wooden splint soaking in a sample of **solution B** labelled **solution B**
- (xi) burner and a means to light it
- (xii) heatproof mat
- (xiii) distilled/deionised water.

Note 1

Centres may provide fewer test-tubes, the minimum being 3 test-tubes (125 mm × 15 mm). If this is the case, candidates will have to rinse test-tubes with distilled water which must be provided and a means to dispose of the waste water.

Apparatus for Question 3

Each candidate will require:

- (i) a resistance wire of length about 105 cm. 32 swg (0.274 mm diameter) constantan (Eureka) is suitable, or any other wire with a resistance of approximately $8 \Omega \text{ m}^{-1}$. See note 1
- (ii) metre rule or wooden strip. See note 1
- (iii) a resistor of nominal value 4.7Ω with a power rating of at least 2 W. See note 2
- (iv) power supply of approximately 3 V. See note 3. Where candidates are provided with a variable power supply, the voltage should be set by the Supervisor and fixed, e.g. taped
- (v) switch. The switch may be an integral part of the power supply
- (vi) sufficient connecting leads to set up the circuit shown in Fig. 3.1. See note 4
- (vii) crocodile clip. See note 4
- (viii) ammeter capable of measuring currents up to 1.00 A with a resolution of at least 0.05 A. See note 5
- (ix) voltmeter capable of measuring up to 3.0 V with a resolution of at least 0.1 V. See note 5.

Notes

1. The resistance wire should be taped to the metre rule or wooden strip between the 0 and 5 cm marks and the 95 and 100 cm marks so that candidates can connect a crocodile clip to points on the wire that will allow them to obtain potential difference values between 0.2 V and 1.6 V. This range may be reduced when using batteries. If this is the case, increase the source voltage to 4.5 V.
2. The resistor must be labelled **X**. The value of resistance must not be visible to the candidates.
3. If cells are used, they must remain adequately charged throughout the examination. Spare cells must be available.
4. The circuit is to be set up for candidates as shown in Fig. 3.1, with the crocodile clip clipped to the resistance wire. The position of the crocodile clip is not important.

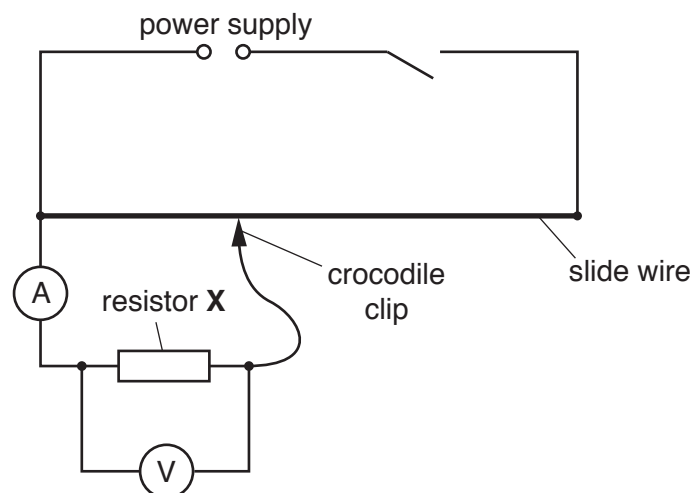
**Fig. 3.1**

5. Either analogue or digital meters are suitable. Any variable settings should be set by the Supervisor and fixed, e.g. taped. Spare meters should be available.

Action at changeover

Ensure that the circuit is connected as shown in Fig. 3.1 and check that the circuit is working. Open the switch.

Apparatus for Question 4

No apparatus is required for this question.

Permission to reproduce items where third-party owned material protected by copyright is included has been sought and cleared where possible. Every reasonable effort has been made by the publisher (UCLES) to trace copyright holders, but if any items requiring clearance have unwittingly been included, the publisher will be pleased to make amends at the earliest possible opportunity.

To avoid the issue of disclosure of answer-related information to candidates, all copyright acknowledgements are reproduced online in the Cambridge Assessment International Education Copyright Acknowledgements Booklet. This is produced for each series of examinations and is freely available to download at www.cambridgeinternational.org after the live examination series.

Cambridge Assessment International Education is part of Cambridge Assessment. Cambridge Assessment is the brand name of the University of Cambridge Local Examinations Syndicate (UCLES), which is a department of the University of Cambridge.

Supervisor's report

Syllabus and component number

				/		
--	--	--	--	---	--	--

Centre number

--	--	--	--	--

Centre name

Time of the practical session

Laboratory name/number

Give details of any difficulties experienced by the centre or by candidates (include the relevant candidate names and candidate numbers).

You must include:

- any difficulties experienced by the centre in the preparation of materials
- any difficulties experienced by candidates, e.g. due to faulty materials or apparatus
- any specific assistance given to candidates.

Declaration

- 1 Each packet that I am returning to Cambridge International contains all of the following items:
 - the scripts of the candidates specified on the bar code label provided
 - the supervisor’s results relevant to these candidates
 - the supervisor’s reports relevant to these candidates
 - seating plans for each practical session, referring to each candidate by candidate number
 - the attendance register.
- 2 Where the practical exam has taken place in more than one practical session, I have clearly labelled the supervisor’s results, supervisor’s reports and seating plans with the time and laboratory name/number for each practical session.
- 3 I have included details of difficulties relating to each practical session experienced by the centre or by candidates.
- 4 I have reported any other adverse circumstances affecting candidates, e.g. illness, bereavement or temporary injury, directly to Cambridge International on a *special consideration form*.

Signed (supervisor)

Name (in block capitals)