



Cambridge International Examinations
Cambridge International General Certificate of Secondary Education

PHYSICS (US)

0443/13

Paper 1 Multiple Choice

May/June 2014

45 minutes

Additional Materials: Multiple Choice Answer Sheet
Soft clean eraser
Soft pencil (type B or HB recommended)

* 4 2 0 0 0 0 5 5 5 2 *

READ THESE INSTRUCTIONS FIRST

Write in soft pencil.
Do not use staples, paper clips, glue or correction fluid.
Write your name, Center number and candidate number on the Answer Sheet in the spaces provided unless this has been done for you.
DO NOT WRITE IN ANY BARCODES.

There are **forty** questions on this paper. Answer **all** questions. For each question there are four possible answers **A, B, C** and **D**.
Choose the **one** you consider correct and record your choice in **soft pencil** on the separate Answer Sheet.

Read the instructions on the Answer Sheet very carefully.

Each correct answer will score one mark. A mark will not be deducted for a wrong answer.
Any rough working should be done in this booklet.
Electronic calculators may be used.

This document consists of **19** printed pages and **1** blank page.

2

- 1 Which instrument is used to compare the masses of objects?
- A a balance
 - B a barometer
 - C a manometer
 - D a graduated cylinder
- 2 The graph shows how the speed of a car changes with time.

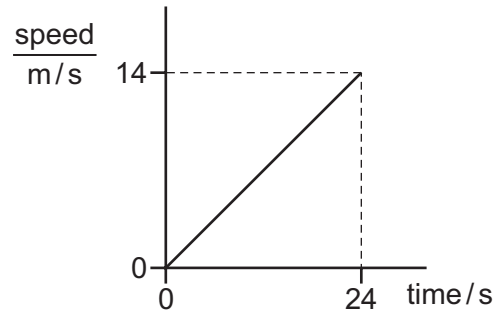

Which calculation gives the distance traveled by the car in 24 seconds?

- A $\left(\frac{14}{24}\right)\text{m}$
- B $\left(\frac{24}{14}\right)\text{m}$
- C $\left(\frac{24 \times 14}{2}\right)\text{m}$
- D $(24 \times 14)\text{m}$

3 Which distance / time graph represents the motion of an object moving at constant speed?

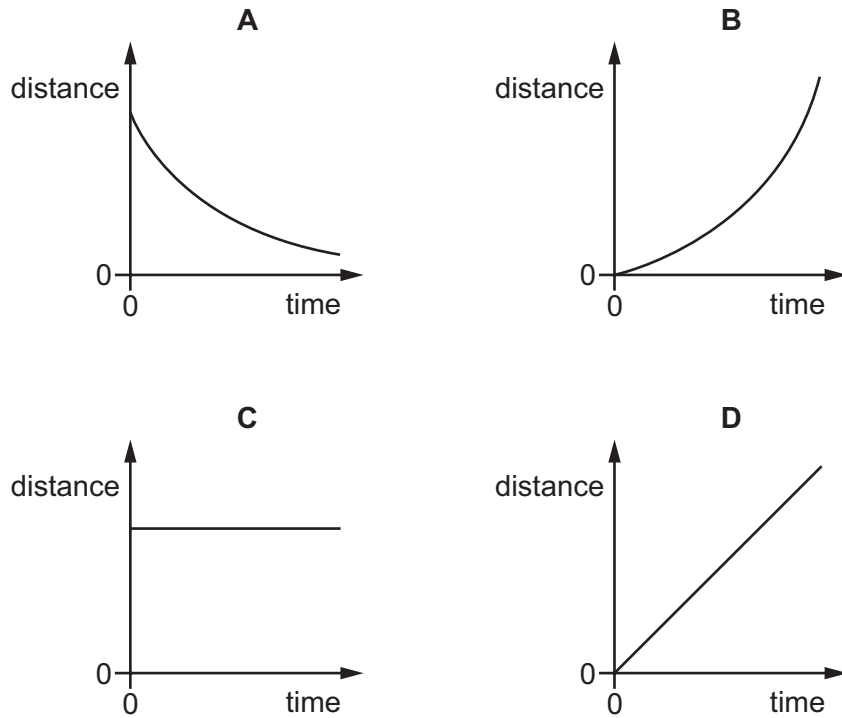

4 A student wishes to measure accurately the volume of approximately 40 cm³ of water. She has two graduated cylinders, a larger one that can hold 100 cm³, and a smaller one that can hold 50 cm³. The water forms a meniscus where it touches the glass.

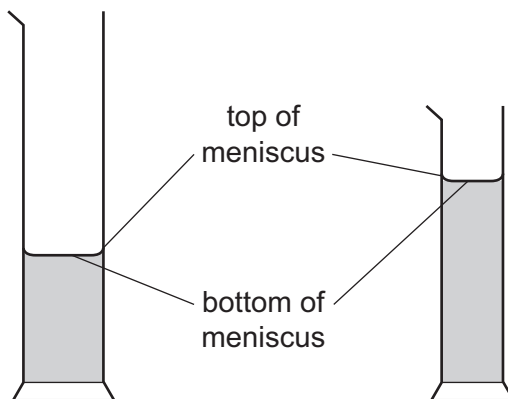

Which cylinder should the student use and which water level should she use to ensure an accurate result?

	cylinder	water level
A	larger one	bottom of meniscus
B	larger one	top of meniscus
C	smaller one	bottom of meniscus
D	smaller one	top of meniscus

4

- 5 A student adds weights to an elastic cord. He measures the length of the cord for each weight. He then plots a graph from the results, as shown.

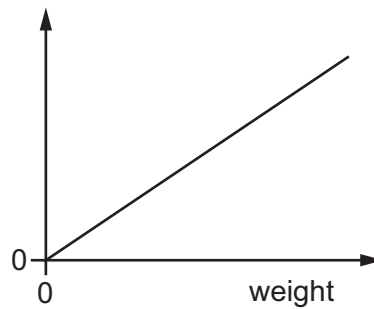

What has he plotted on the vertical axis?

- A measured length
 - B original length
 - C (measured length + original length)
 - D (measured length – original length)
- 6 A liquid has a volume of 100 cm^3 and a mass of 85 g.
The density of water is 1.0 g/cm^3 .
How does the density of the liquid compare with the density of water?
- A Its density is higher than that of water.
 - B Its density is lower than that of water.
 - C Its density is the same as that of water.
 - D It is impossible to say with only this data.
- 7 Which situation is an example of a force acting over a large area to produce a small pressure?
- A a builder hammering a nail into a piece of wood
 - B a cook using a sharp knife to cut vegetables
 - C a nurse pushing a needle into a patient's arm
 - D a soldier marching in flat-soled boots

8 A student places four identical beakers on a bench.

Two beakers contain salt water of density 1.1g/cm^3 and two beakers contain pure water of density 1.0g/cm^3 .

Which beaker exerts the greatest pressure on the bench?

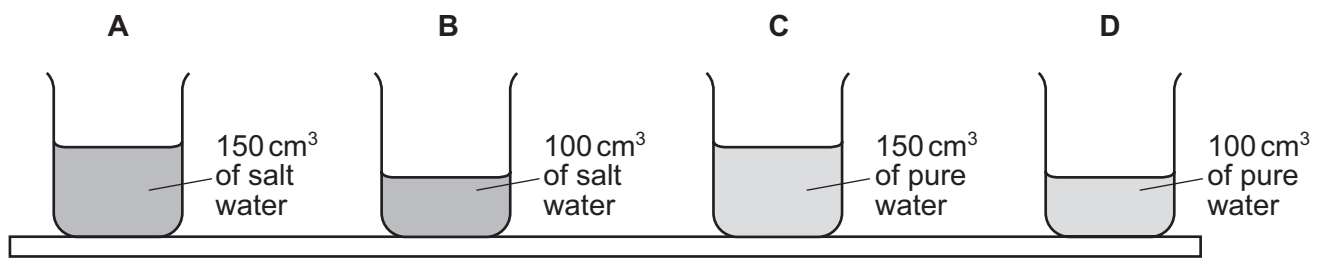

9 A plane lamina with center of mass X touches the ground at point P.

Which diagram shows the lamina in equilibrium?

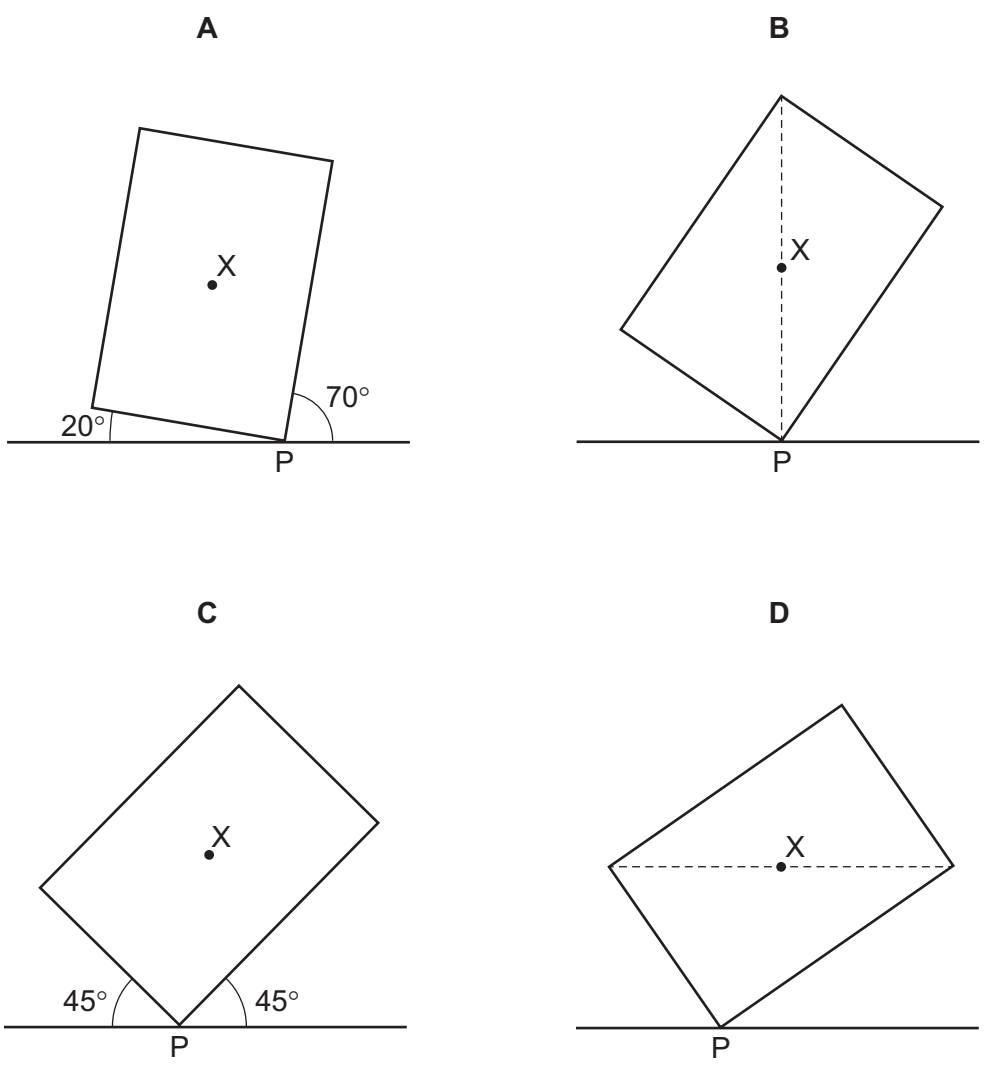

10 Four cars are driven along a road.

The table shows the work done by the engine in each car and the time taken by each car.

Which engine produces the most power?

	work done by engine / J	time taken / s
A	50 000	20
B	50 000	40
C	100 000	20
D	100 000	40

11 Which energy transfer takes place when a matchstick burns?

- A** chemical to thermal
- B** chemical to nuclear
- C** nuclear to chemical
- D** thermal to chemical

12 The diagram shows a heater above a thermometer. The thermometer bulb is in the position shown.

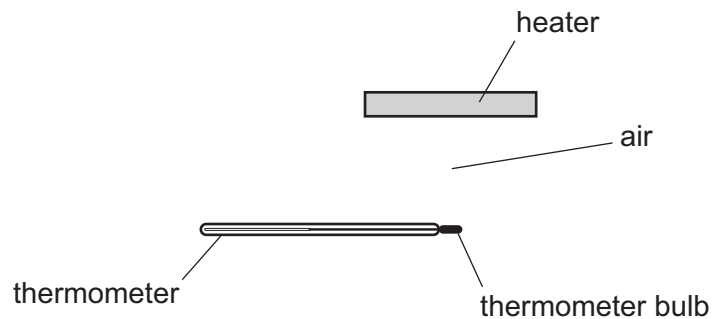

Which row shows how the heat energy from the heater reaches the thermometer bulb?

	conduction	convection	radiation
A	yes	yes	no
B	yes	no	yes
C	no	yes	no
D	no	no	yes

- 13 Which statement about the transfer of thermal energy is correct?
- A All metals conduct thermal energy equally well.
 - B Convection can only occur in solids or liquids.
 - C Convection occurs in liquids because hot liquid is more dense than cold liquid.
 - D The radiation that transfers thermal energy is a type of electromagnetic radiation.

14 In an experiment, a thermometer is placed in a test-tube of hot liquid. The temperature of the liquid is recorded every half minute. The table shows the results.

time/minutes	0.0	0.5	1.0	1.5	2.0	2.5	3.0	3.5	4.0	4.5	5.0	5.5	6.0	6.5	7.0	7.5
temperature/°C	73	65	59	55	55	55	51	48	45	42	40	38	36	35	34	33

What is the melting point of the substance?

- A 0°C
- B 33°C
- C 55°C
- D 73°C

15 A telephone engineer connects a wire between two poles when the weather is very cold.

He makes the wire very loose. The wire passes over a road.

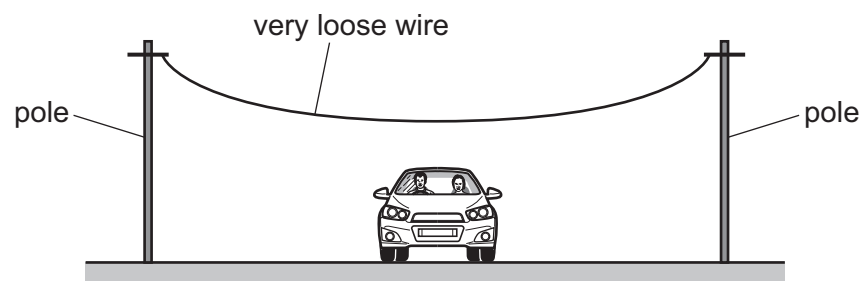

The weather changes and it becomes very hot.

What could happen to the wire and why?

	what could happen	why
A	it breaks	it contracts
B	it breaks	it expands
C	it sags and touches cars on the road	it contracts
D	it sags and touches cars on the road	it expands

- 16 During evaporation, molecules escape rapidly from the surface of a liquid.

What happens to the average energy of the molecules of the remaining liquid and what happens to the temperature of the remaining liquid?

	average energy of remaining molecules	temperature of remaining liquid
A	decreases	decreases
B	decreases	increases
C	stays the same	decreases
D	stays the same	increases

- 17 A student places his thumb firmly on the outlet of a bicycle pump, to stop the air coming out.

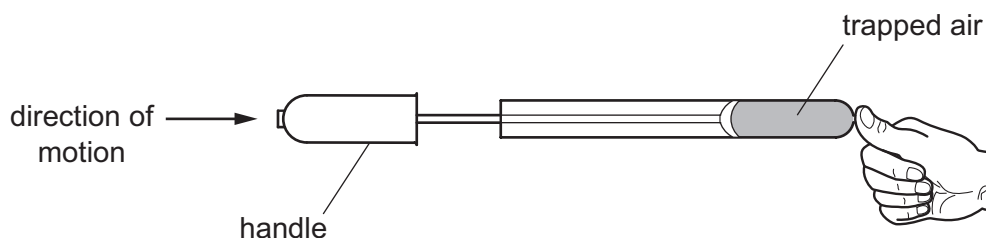

What happens to the pressure and what happens to the volume of the trapped air as the pump handle is pushed in?

	pressure	volume
A	decreases	decreases
B	decreases	remains the same
C	increases	decreases
D	increases	remains the same

- 18 A boy blows a whistle that has a frequency of 10 000 Hz. The boy's friend cannot hear the sound from the whistle. The friend has normal hearing.

What could be a reason why he cannot hear the sound?

- A** The amplitude is too large.
- B** The amplitude is too small.
- C** The frequency is too high.
- D** The frequency is too low.

- 19 A lighted candle is placed in front of a loudspeaker that is making a loud, steady note. The candle flame vibrates because of the sound wave.

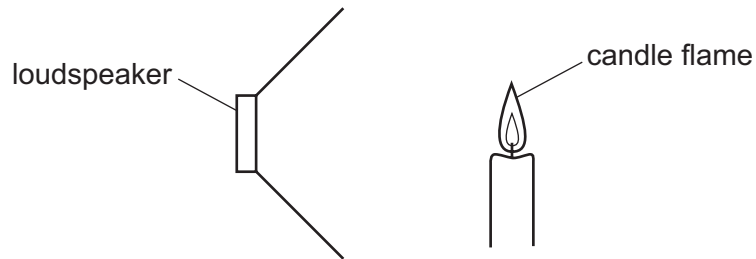

Which type of waves are sound waves and in which direction does the flame vibrate?

	type of wave	direction of vibration
A	longitudinal	↑ ↓
B	transverse	↑ ↓
C	longitudinal	← →
D	transverse	← →

- 20 Which list shows electromagnetic waves in order of increasing frequency?

- A** visible light, X-rays, γ -rays
- B** visible light, γ -rays, X-rays
- C** X-rays, γ -rays, visible light
- D** γ -rays, X-rays, visible light

21 A small boat in a harbor is protected from waves on the sea by harbor walls.

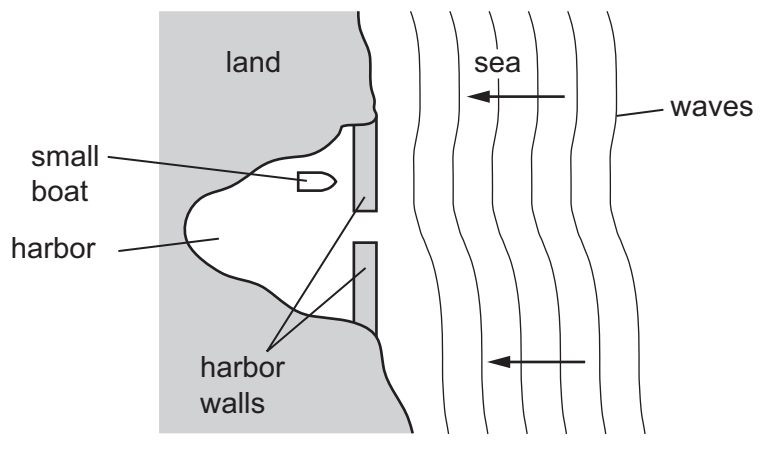

Some waves can curve round the harbor walls and reach the boat.

What is the name of this effect?

- A diffraction
- B dispersion
- C reflection
- D refraction

22 Scout P signals to scout Q on the other side of a valley by using a mirror to reflect the Sun's rays.

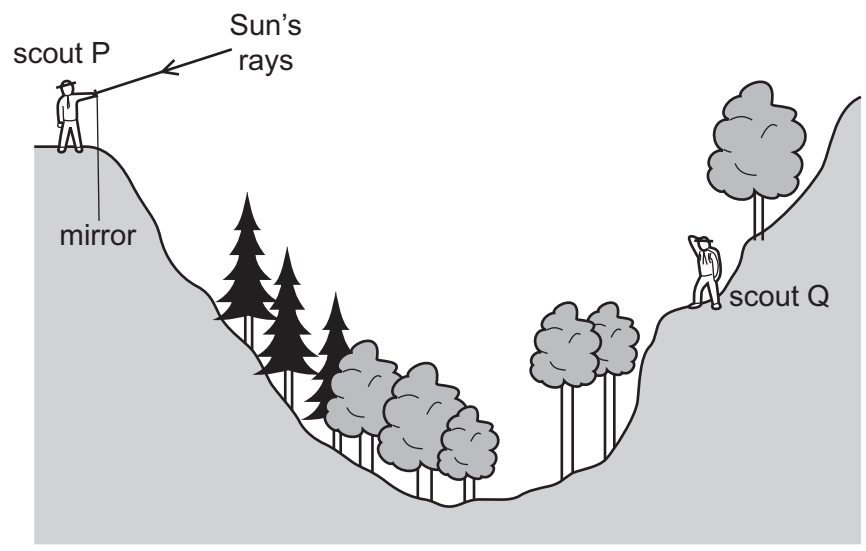

Which mirror position would allow the Sun's rays to be reflected to scout Q?

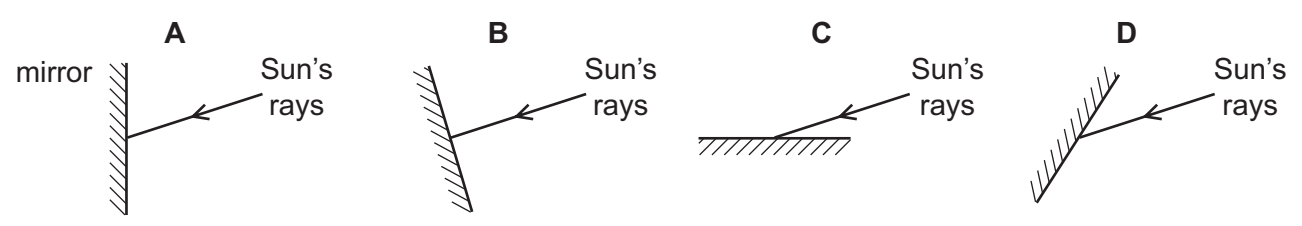

23 Which statement about a converging lens is **not** correct?

- A A ray parallel to the principal axis of the lens is refracted through the principal focus.
- B All rays of light refracted by the lens pass through the principal focus.
- C The distance between the center of the lens and the principal focus is the focal length.
- D The principal focus of the lens is a point on the principal axis.

24 Rays of light enter and leave a box.

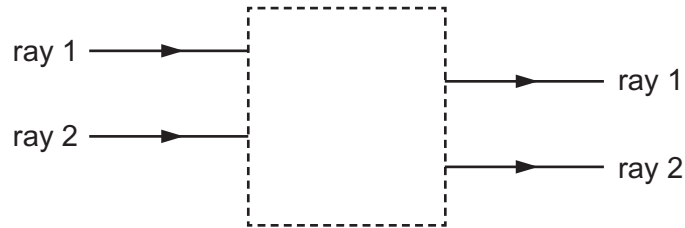

What could be inside the box to make the rays behave as shown?

- A a converging lens
 - B a parallel-sided glass block
 - C a plane mirror
 - D a triangular prism
- 25 A plastic rod and a dry cloth are uncharged.

The rod is now rubbed with the cloth and they both become charged. The rod becomes negatively charged because some charged particles move from the cloth to the rod.

What is the charge on the cloth and which particles moved in the charging process?

	charge on cloth	particles that moved
A	negative	electrons
B	negative	neutrons
C	positive	electrons
D	positive	neutrons

26 The diagram shows a circuit containing three lamps and three switches S_1 , S_2 and S_3 .

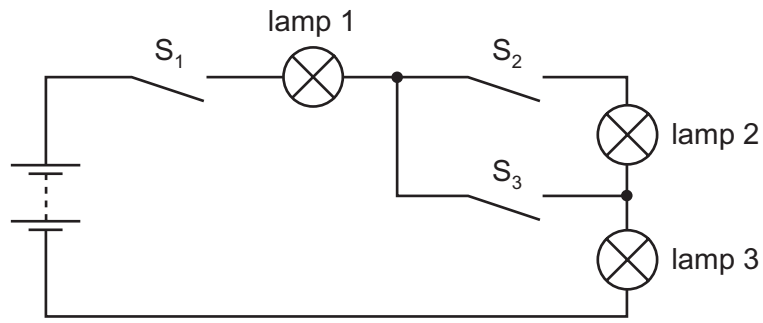

Lamp 1 and lamp 3 are lit, but lamp 2 is not lit.

Which switch or switches is/are closed?

- A S_1 only
- B S_1 and S_2
- C S_1 and S_3
- D S_2 and S_3

27 Which labeled component in the circuit shown controls the brightness of lamp X?

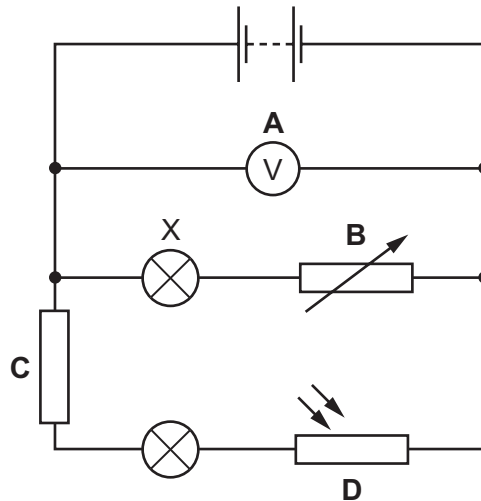

13

28 The diagram shows part of an electric circuit.

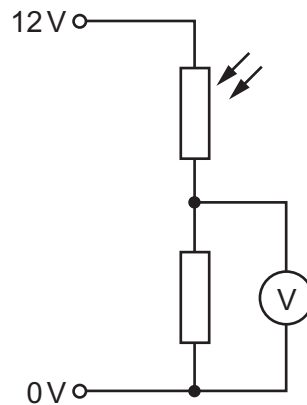

The light falling on the light-dependent resistor (LDR) increases in brightness.

What happens to the resistance of the LDR and what happens to the reading on the voltmeter?

	resistance of LDR	reading on voltmeter
A	decreases	decreases
B	decreases	increases
C	increases	decreases
D	increases	increases

29 The diagram shows an incomplete circuit.

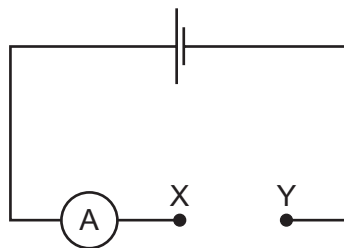

Four wires of different length and thickness are connected in turn between point X and point Y. All four wires are made of the same metal.

Which wire will cause the greatest reading on the ammeter?

- A** long and thick
- B** long and thin
- C** short and thick
- D** short and thin

30 The diagram shows a circuit containing a battery, a lamp, a switch and another component. The switch is initially closed and the lamp is lit.

The switch is now opened and the lamp remains lit for several seconds before slowly going out.

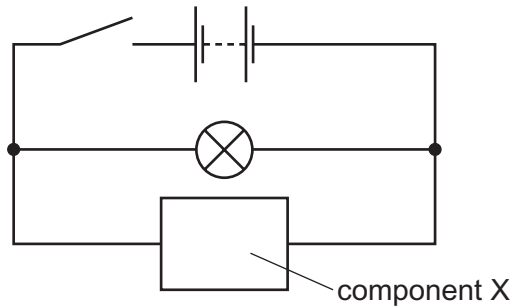

What is component X?

- A a capacitor
- B a light-dependent resistor
- C a thermistor
- D a variable resistor

31 An appliance is connected to a mains supply. Its circuit also contains a switch and a fuse.

Which circuit shows the fuse in the correct position?

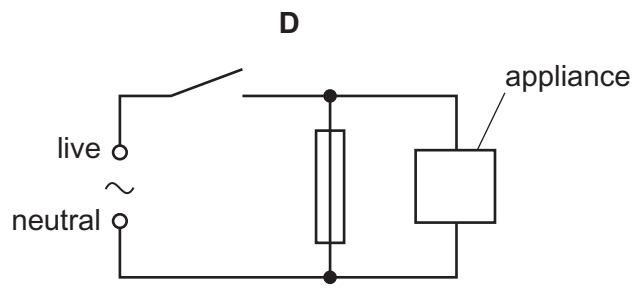
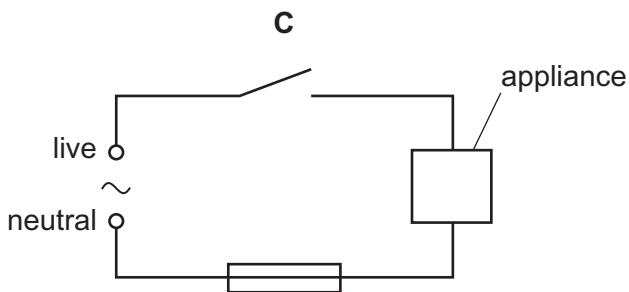
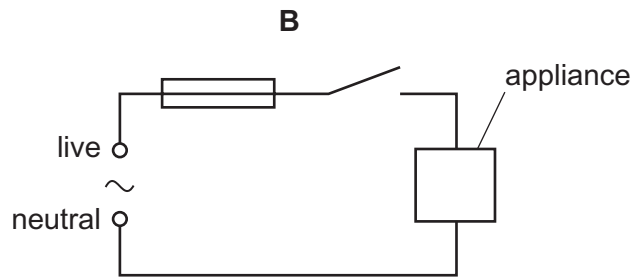
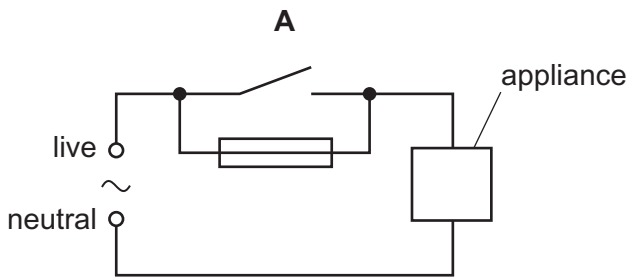

32 Two iron nails hang from a bar magnet.

Which diagram shows the magnetic poles induced in the nails?

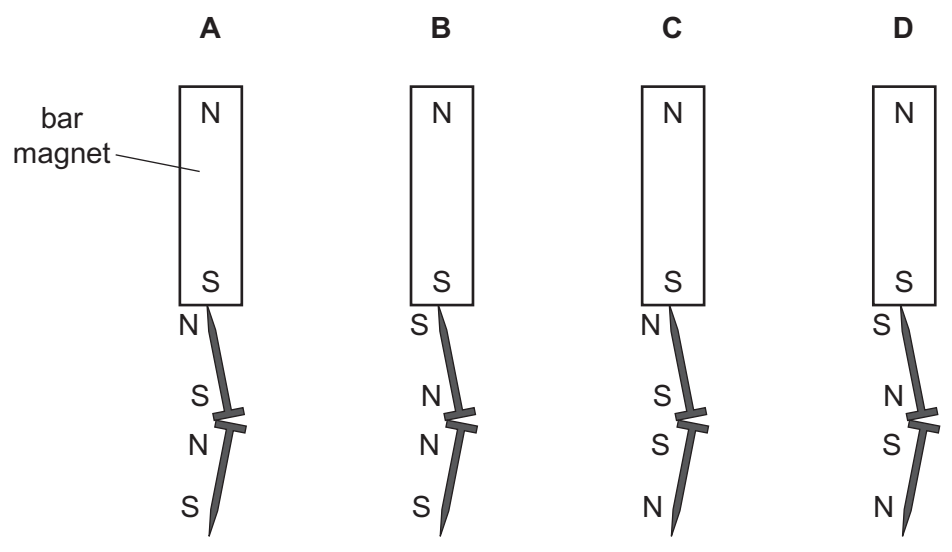

33 A steel magnet is placed inside a coil of wire. There is a large alternating current in the coil. The magnet is slowly moved out of the coil to position P.

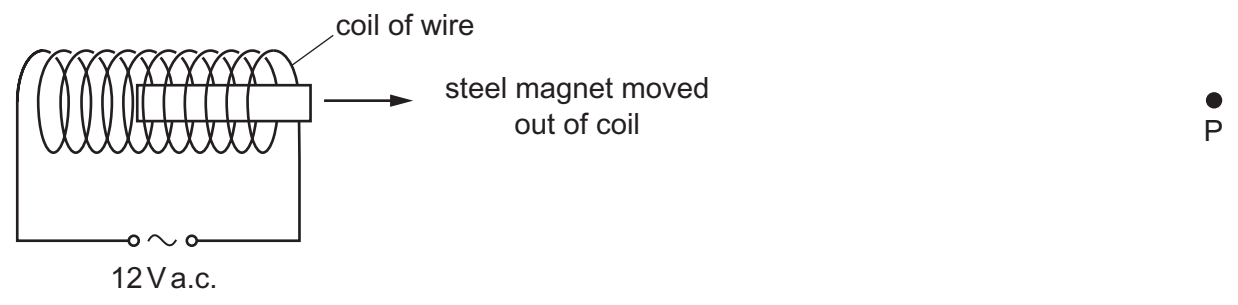

How has the steel changed, if at all, when it reaches position P?

- A It has become a stronger magnet.
- B It has become demagnetized.
- C The poles have changed ends.
- D There has been no change.

- 34 When a wire is moved upwards between the poles of a magnet, an electromotive force is induced across the ends of the wire.

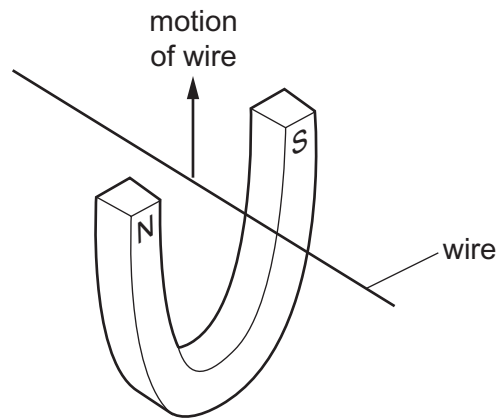

Which device uses a moving wire to induce an e.m.f.?

- A a cathode-ray tube
- B a generator
- C a transformer
- D an electromagnet

17

- 35 An electric current is passed through a coil of wire.

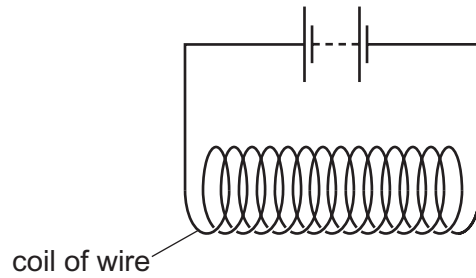

Which diagram shows the shape of the magnetic field produced in the middle of the coil?

A

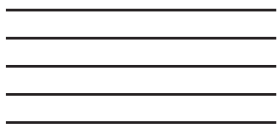

B

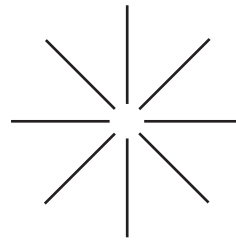

C

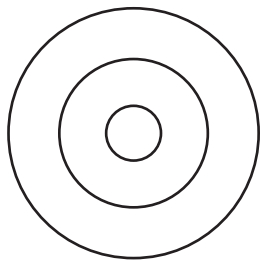

D

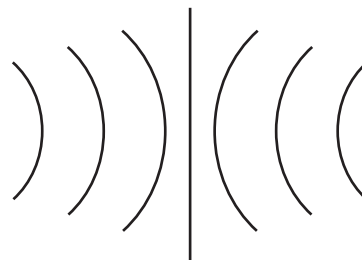

- 36 An input voltage of 10V is supplied to the primary coil of a transformer. An output voltage of 40V is produced across the secondary coil.

The 10V supply at the primary coil is now replaced with a 40V supply.

What is the new output voltage across the secondary coil?

- A 10V B 40V C 70V D 160V
- 37 A lithium nucleus contains 3 protons and 4 neutrons.

What is its nuclide notation?

- A ${}^3_4\text{Li}$ B ${}^4_3\text{Li}$ C ${}^7_3\text{Li}$ D ${}^7_4\text{Li}$

18

38 The diagram shows a box used for storing radioactive sources.

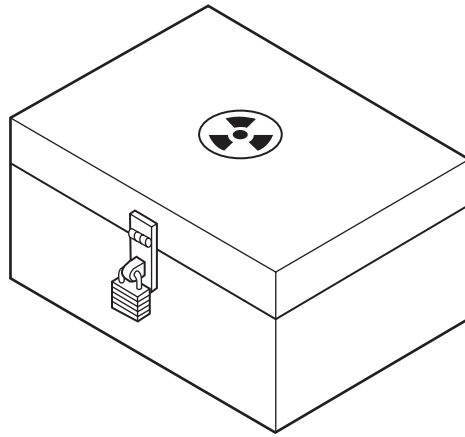

Which material is best for lining the box to prevent the escape of most radioactive emissions?

- A aluminum
- B copper
- C lead
- D steel

39 The table shows the results of an experiment to find the half-life of a radioactive substance.

time / s	count rate from substance
	counts / second
0	150
60	120
120	95
180	75
240	60

What is the half-life of the substance?

- A 60 seconds
- B 120 seconds
- C 180 seconds
- D 240 seconds

40 A beam of cathode rays passes between two parallel metal plates connected to a d.c. power supply.

Which path does the beam follow?

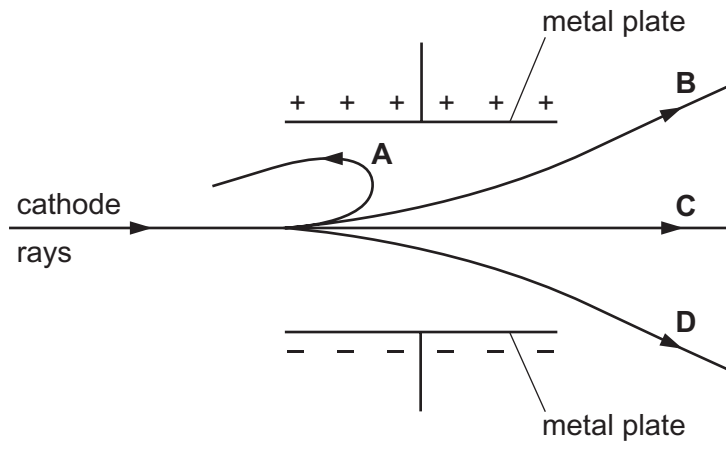

Permission to reproduce items where third-party owned material protected by copyright is included has been sought and cleared where possible. Every reasonable effort has been made by the publisher (UCLES) to trace copyright holders, but if any items requiring clearance have unwittingly been included, the publisher will be pleased to make amends at the earliest possible opportunity.

Cambridge International Examinations is part of the Cambridge Assessment Group. Cambridge Assessment is the brand name of University of Cambridge Local Examinations Syndicate (UCLES), which is itself a department of the University of Cambridge.

© UCLES 2014