

CAMBRIDGE INTERNATIONAL EXAMINATIONS
International General Certificate of Secondary Education

PHYSICS

0625/01

Paper 1 Multiple Choice

October/November 2003

45 minutes

Additional Materials: Multiple Choice Answer Sheet
Soft clean eraser
Soft pencil (type B or HB is recommended)

READ THESE INSTRUCTIONS FIRST

Write in soft pencil.

Do not use staples, paper clips, highlighters, glue or correction fluid.

Write your name, Centre number and candidate number on the Answer Sheet in the spaces provided unless this has been done for you.

There are **forty** questions on this paper. Answer **all** questions. For each question there are four possible answers **A, B, C, and D**.

Choose the **one** you consider correct and record your choice in **soft pencil** on the separate Answer Sheet.

Read the instructions on the Answer Sheet very carefully.

Each correct answer will score one mark. A mark will not be deducted for a wrong answer.
Any rough working should be done in this booklet.

2

- 1 Which of the following is **not** necessary when using a measuring cylinder to measure the volume of a quantity of water?
- A** making sure that the measuring cylinder is vertical
B making sure that your eye is level with the liquid surface
C reading the bottom of the meniscus
D using the largest measuring cylinder possible
- 2 A pendulum is set in motion and 20 complete swings are timed. The time measured is 30 s.
What is the time for one complete swing of the pendulum?
- A** 0.67 s **B** 0.75 s **C** 1.5 s **D** 3.0 s
- 3 Five telegraph poles are positioned at equal distances along the side of a road.

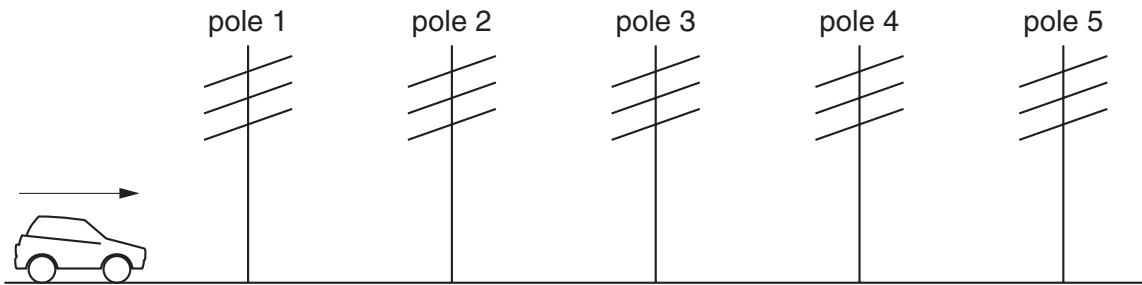

A car accelerates until it is level with pole 4. The car then continues along the road at a steady speed. The times taken to travel between one pole and the next are measured.

Which time is the greatest?

The time between

- A** pole 1 and pole 2.
B pole 2 and pole 3.
C pole 3 and pole 4.
D pole 4 and pole 5.

- 4 A train travels along a track from Aytown to Beetown. The map shows the route.

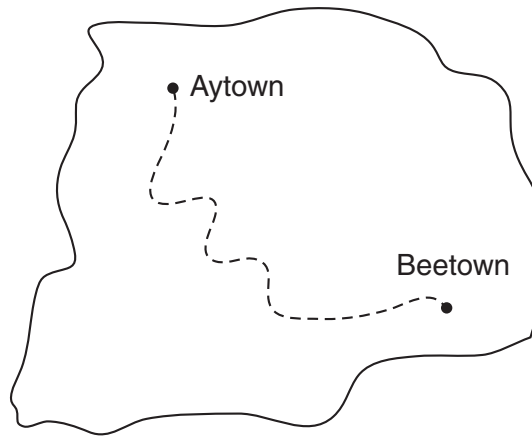

The distance travelled by the train between the towns is 210 km. It moves at an average speed of 70 km/h.

How long does the journey take?

- A less than $\frac{70}{210}$ hours, because the journey is not in a straight line
- B exactly $\frac{70}{210}$ hours
- C exactly $\frac{210}{70}$ hours
- D more than $\frac{210}{70}$ hours, because the journey is not in a straight line
- 5 A beam is pivoted at its centre. Two masses are suspended at equal distances from the pivot as shown in the diagram.

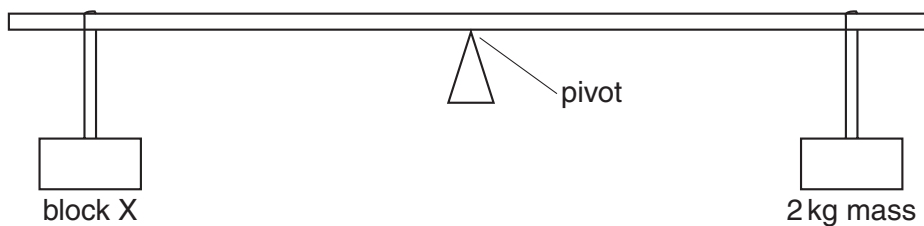

Which statement is correct?

- A If X has a mass of exactly 2 kg, it will rise.
- B If X has a mass of less than 2 kg, it will fall.
- C If X has a mass of more than 2 kg, it will fall.
- D If X has a mass of more than 2 kg, it will rise.

4

- 6 The mass of a full bottle of cooking oil is 1.30 kg.

When exactly half of the oil has been used, the mass of the bottle plus the remaining oil is 0.90 kg.

What is the mass of the bottle?

- A 0.40 kg B 0.50 kg C 0.65 kg D 0.80 kg
- 7 A student tries to find the density of a metal block. First he measures the weight with a forcemeter (spring balance). Next he measures the sides of the block using a rule, in order to calculate the volume of the block. Finally he divides the weight by the volume to find the density.

The student has made a mistake.

Why does his method **not** give the density?

- A Density is volume divided by weight.
B He should have measured the surface area, not the volume.
C He should have used the mass in his calculation, not the weight.
D Weight is not measured with a forcemeter (spring balance).
- 8 Two forces act on an object.
- In which situation is it **impossible** for the object to be in equilibrium?
- A The two forces act in the same direction.
B The two forces act through the same point.
C The two forces are of the same type.
D The two forces are the same size.

- 9 The table below shows the length of a wire as the load on it is increased.

load / N	0	10	20	30
length / cm	50.0	52.1	54.1	56.3

Which graph correctly shows the extension of the wire plotted against load?

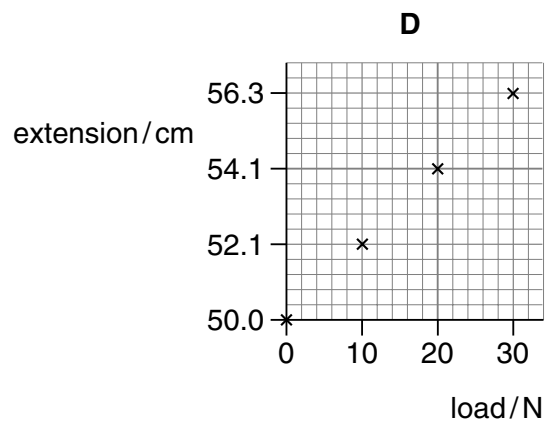
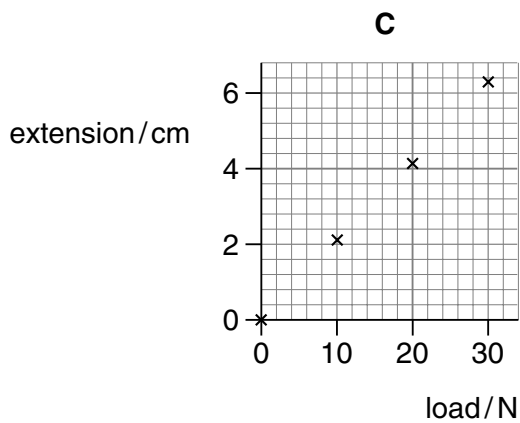
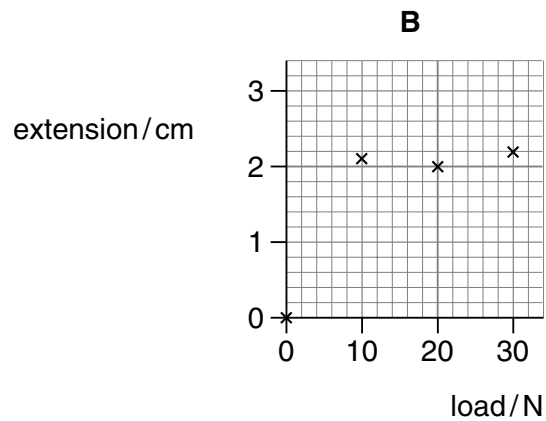
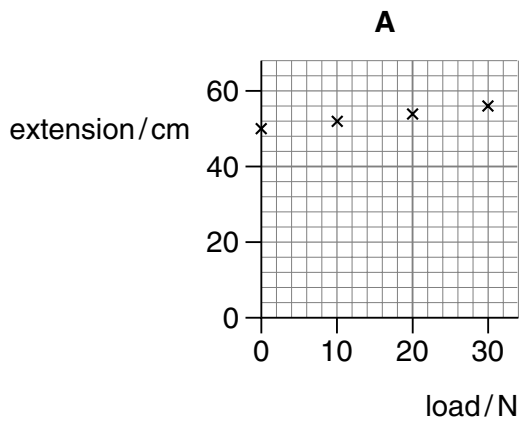

- 10 A large electric motor is used to lift a container off a ship.

Which of the following values are enough to allow the power of the motor to be calculated?

- A** the mass of the container and the distance moved
- B** the force used and the distance moved
- C** the current used and the work done
- D** the work done and the time taken

- 11 A tidal power station is made by building a barrage across the mouth of a river. At low tide sea water is trapped behind the barrage.

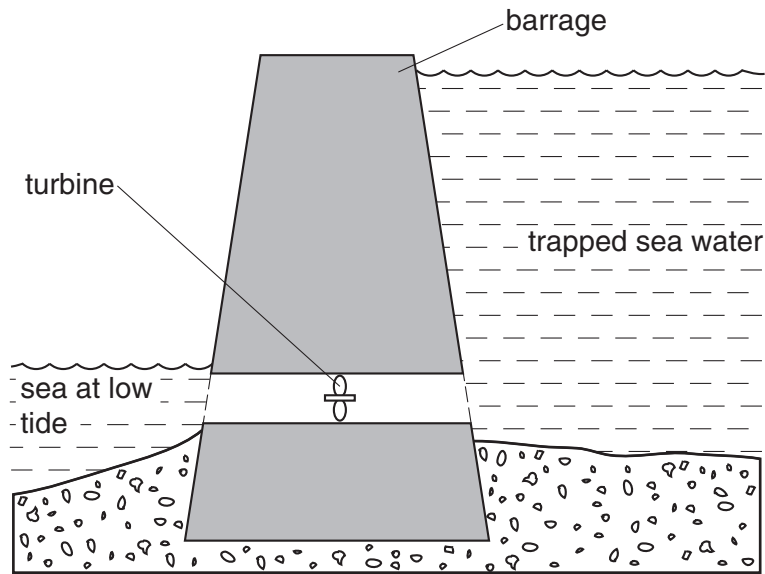

At low tide the water is allowed to flow back into the sea through a turbine.

What is the useful energy change in a tidal power station?

- A electrical energy → energy of position (potential)
 - B electrical energy → energy of motion (kinetic)
 - C energy of motion (kinetic) → energy of position (potential)
 - D energy of position (potential) → electrical energy
- 12 Which diagram shows the child exerting **least** pressure on the ground?

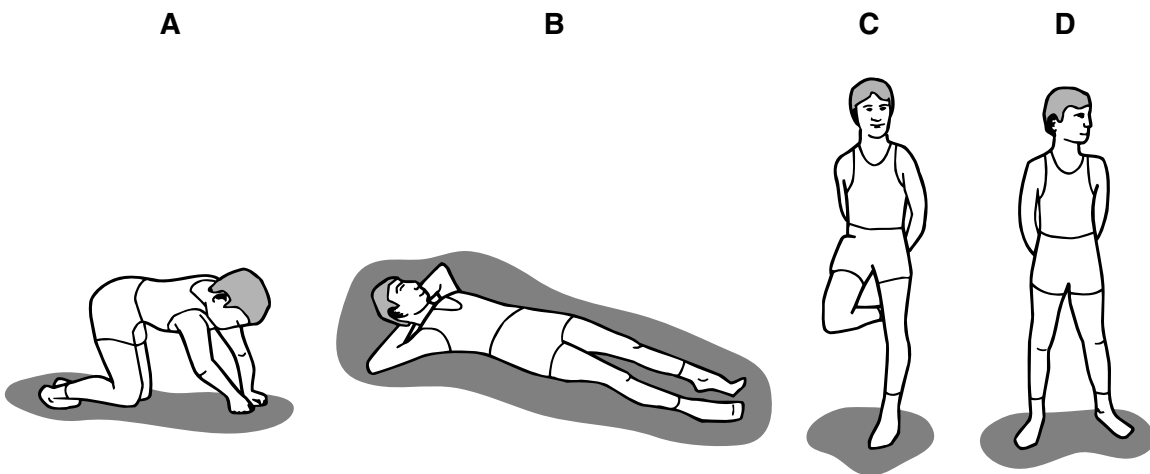

- 13 A manometer is being used to measure the pressure of the gas inside a tank. A, show the manometer at different times.

At which time is the gas pressure inside the tank greatest?

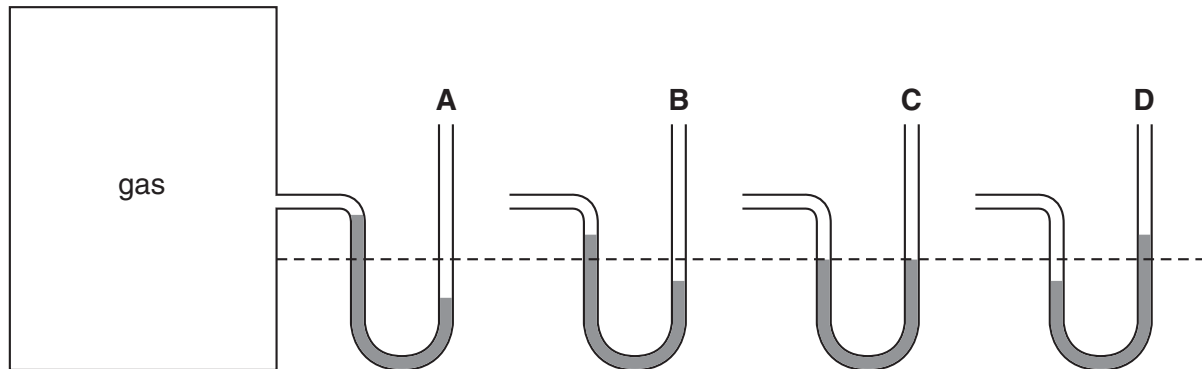

- 14 Which line in the table correctly describes whether the molecules of a solid, liquid and gas are moving or stationary?

	solid	liquid	gas
A	stationary	stationary	stationary
B	stationary	stationary	moving
C	stationary	moving	moving
D	moving	moving	moving

- 15 Driving a car raises the temperature of the tyres.

This causes the pressure of the air in the tyres to increase.

Why is this?

- A Air molecules break up to form separate atoms.
- B Air molecules expand with the rise in temperature.
- C The force between the air molecules increases.
- D The speed of the air molecules increases.

16 The diagram shows how the atoms in a substance rearrange themselves during state.

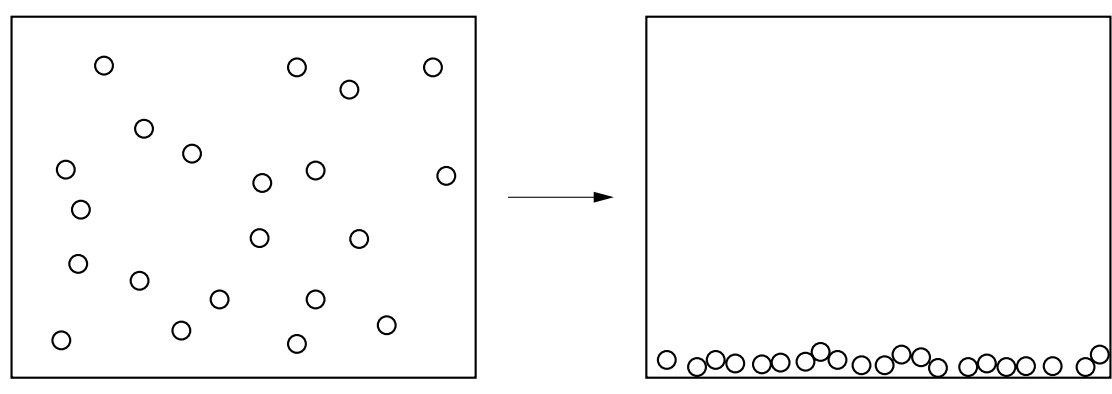

Which change of state is shown?

- A gas to liquid
- B liquid to gas
- C liquid to solid
- D solid to liquid

17 Equal masses of two different liquids are put into identical beakers. They are heated from 20 °C to 30 °C by heaters of the same power. Liquid 2 takes twice as long to heat as liquid 1.

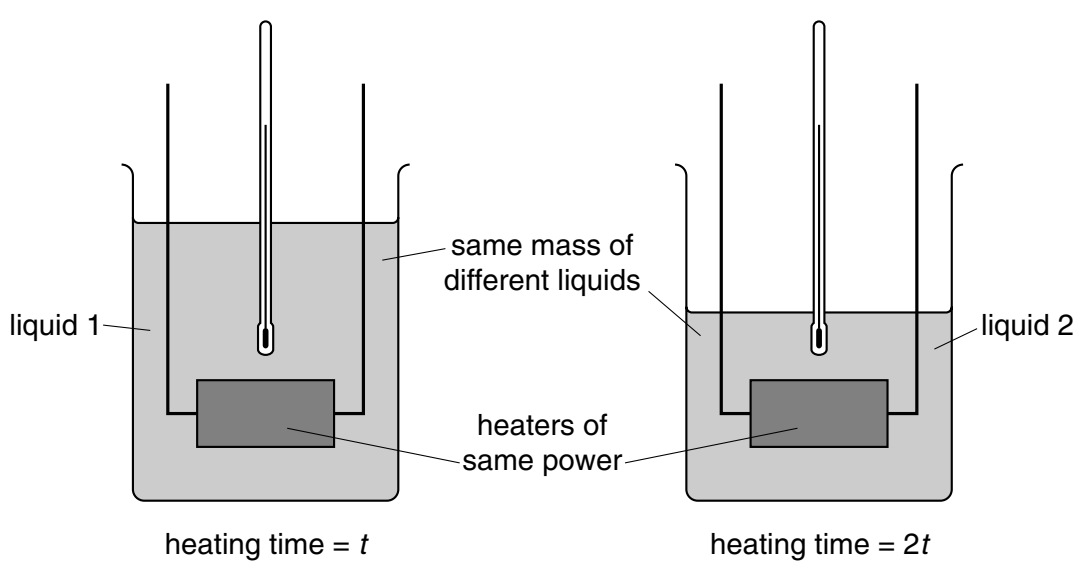

Which statement is correct?

- A Both liquids receive the same amount of energy.
- B Liquid 1 receives more energy than liquid 2.
- C The thermal capacity of liquid 1 is equal to the thermal capacity of liquid 2.
- D The thermal capacity of liquid 1 is less than the thermal capacity of liquid 2.

18 There is a vacuum between the double walls of a vacuum flask.

Which types of heat transfer are reduced by the vacuum?

- A conduction and convection
- B conduction and radiation
- C convection and radiation
- D conduction, convection and radiation

19 The diagrams show four identical pieces of ice that are heated in test-tubes of water.

In which test-tube will the ice take the longest time to melt?

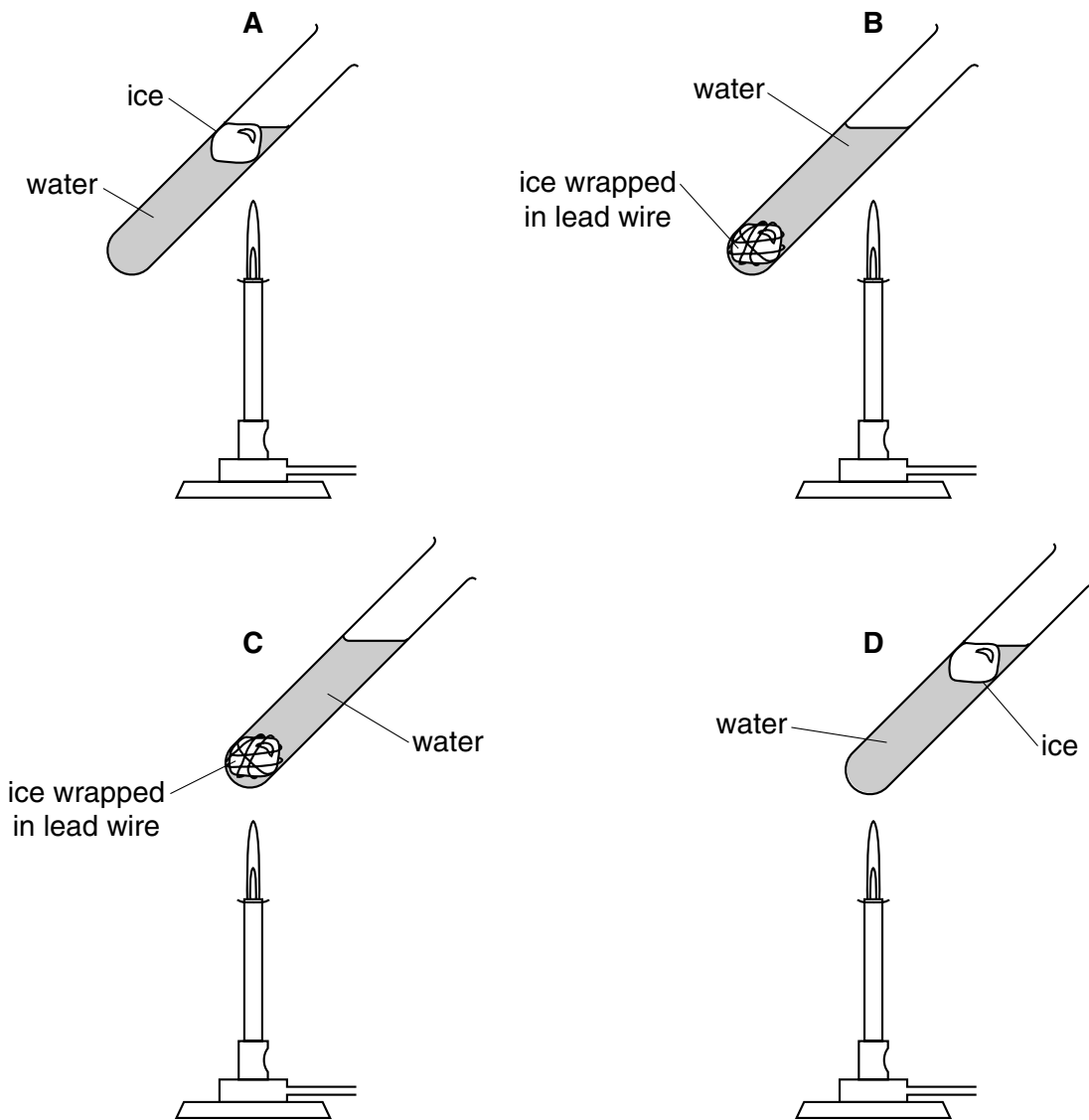

20 The diagram shows a cork with a weight attached so that the cork floats upright.

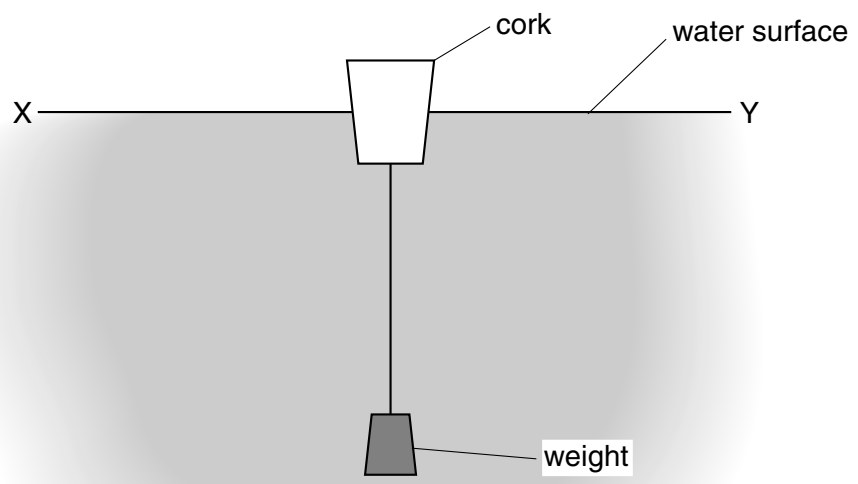

Transverse waves travel across the water from X to Y.

Which way do the waves make the cork move?

- A →← right and left
- B ↑↓ up and down
- C → only to the right
- D ← only to the left

21 Waves travel more slowly on the surface of water when the water is shallow.

A person drops a stone into a pool at X. The diagram shows the first wavefront on the surface of the pool.

Which region of the pool is likely to be most shallow?

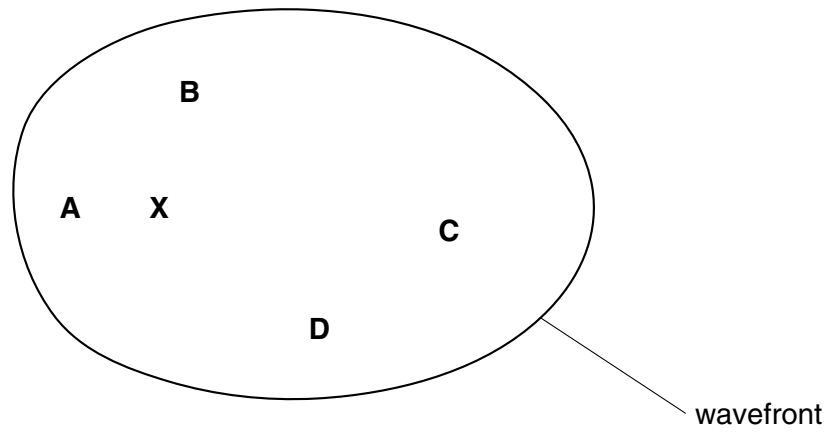

22 Which diagram correctly shows the paths taken by red and blue light when a beam enters a glass prism?

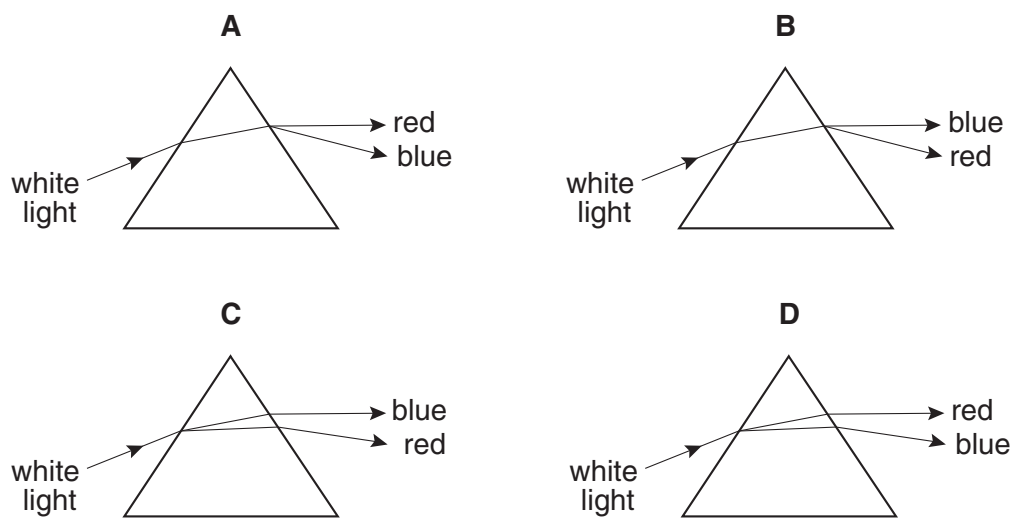

23 Which diagram shows the correct order of the waves in the electromagnetic spectrum?

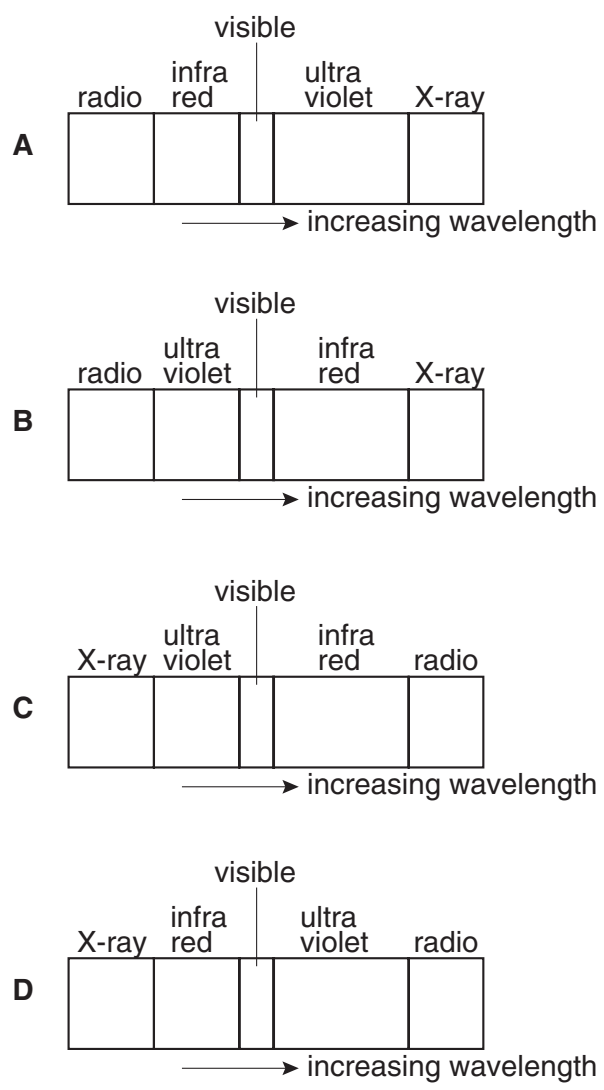

24 Which change will lower the pitch of a sound?

- A decreasing its amplitude
- B decreasing its frequency
- C increasing its amplitude
- D increasing its frequency

25 Astronaut 1 uses a hammer to mend a satellite in space. Astronaut 2 is nearby. There is no atmosphere in space.

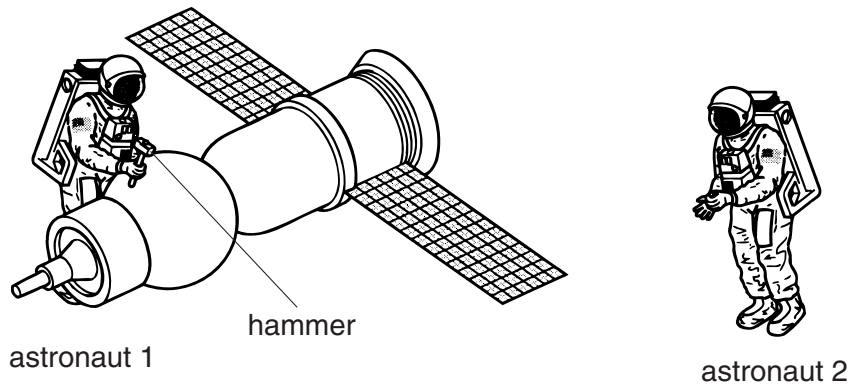

Compared with the sound heard if they were working on Earth, what does astronaut 2 hear?

- A no sound at all
- B a quieter sound
- C a sound of the same loudness
- D a louder sound

26 A steel bar is magnetised by stroking it several times with the south pole of a magnet,

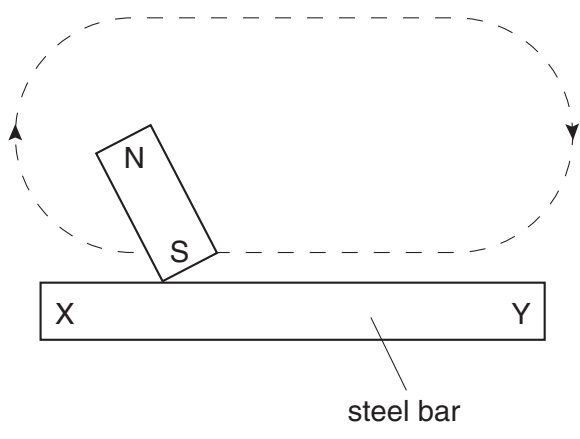

Which poles are formed at X and Y?

	X	Y
A	north	north
B	north	south
C	south	north
D	south	south

27 A steel ball on a horizontal wooden table rolls near the north pole of a bar magnet that is lying on the table.

Which diagram shows the most likely path of the ball, as seen from above the table?

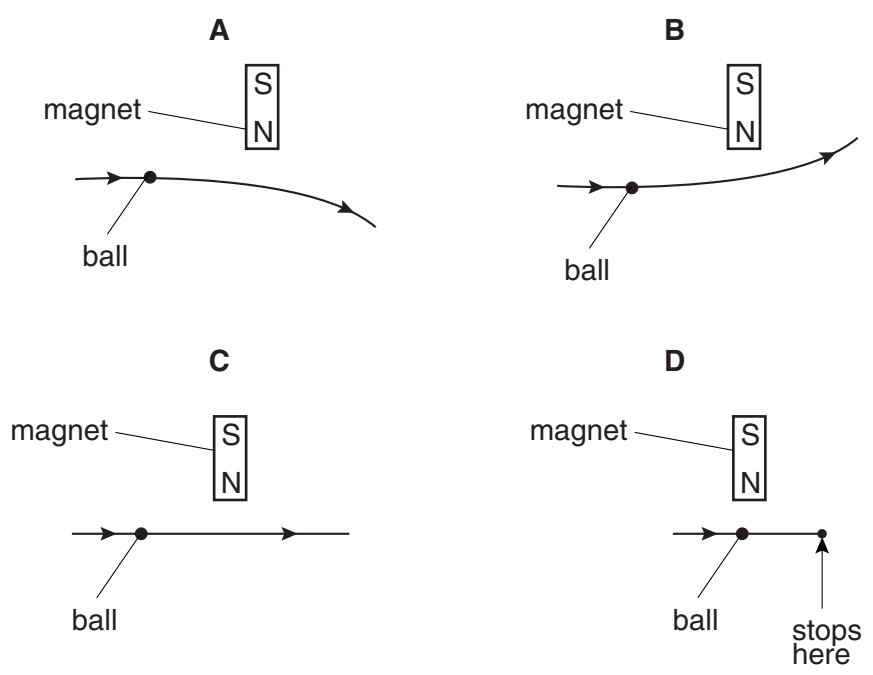

28 A student wants to find the resistance of resistor R using a voltmeter and an ammeter.
Which circuit should the student use?

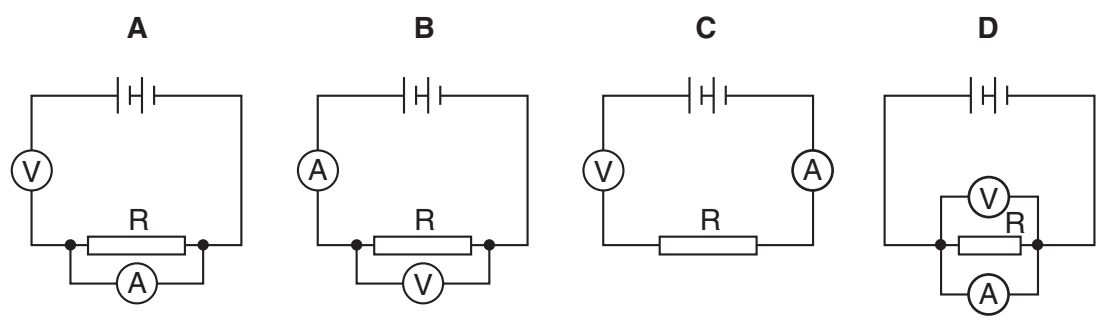

29 Two very light, charged balls P and Q are hung, one above the other, from nylon threads. When a negatively charged plastic sheet is placed alongside them, P is repelled and Q is attracted.

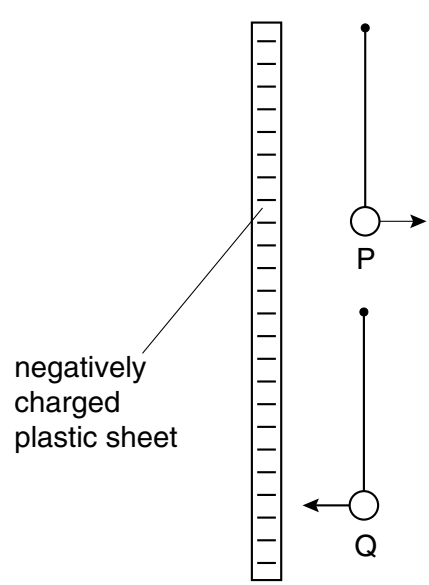

What are the original charges on P and on Q?

	charge on P	charge on Q
A	negative	negative
B	negative	positive
C	positive	negative
D	positive	positive

- 30 Four students are asked to draw a circuit showing three lamps working in parallel, switch that controls all three lamps.

Which student is correct?

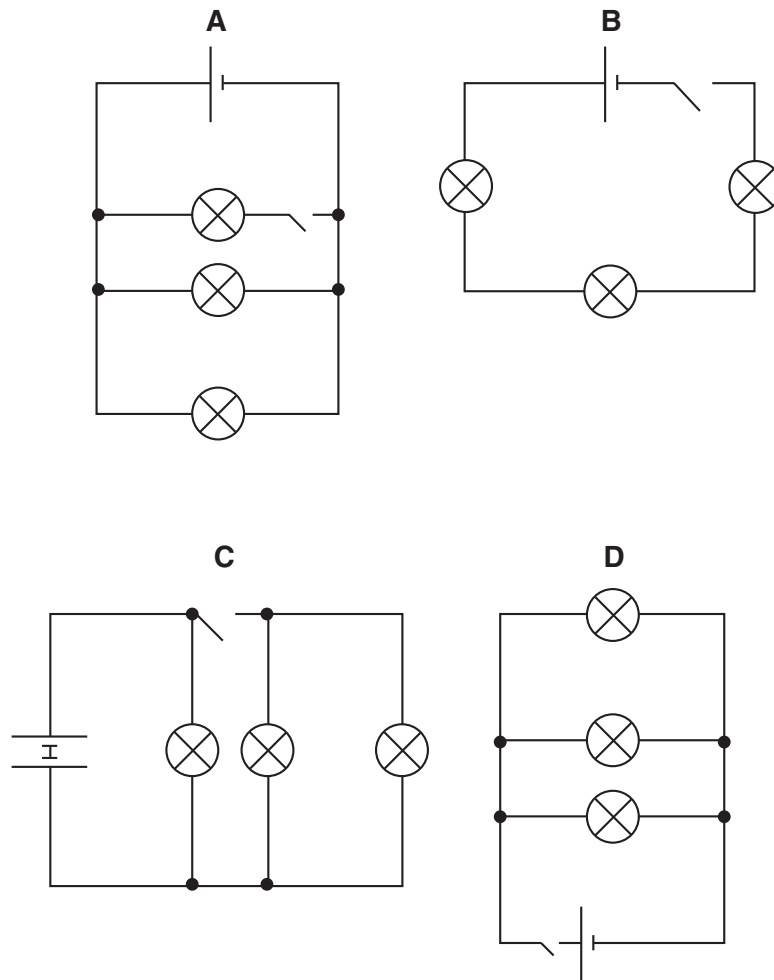

- 31 A $3.0\ \Omega$ lamp and a $6.0\ \Omega$ lamp are connected in series.

What is the total resistance of the combination?

- A $0.5\ \Omega$
 - B $2.0\ \Omega$
 - C $9.0\ \Omega$
 - D $18.0\ \Omega$
- 32 Why is a circuit breaker or a fuse used in a mains electric circuit?
- A It allows spare current to be returned to the mains.
 - B It improves the insulation of the wiring.
 - C It protects the mains wiring from current overload.
 - D It saves energy by reducing the current.

33 The diagrams show two ways in which three lamps may be connected.

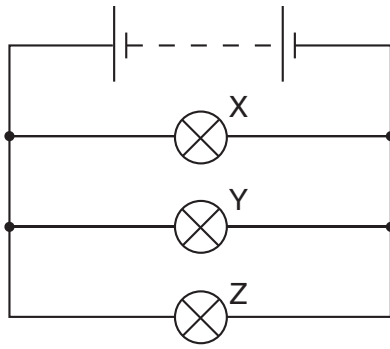

circuit 1

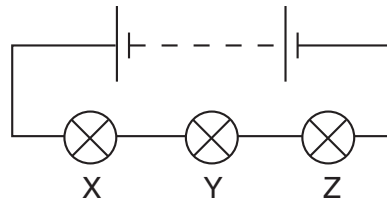

circuit 2

Which statement is correct?

- A If lamp Y breaks in circuit 1, both the other lamps will go out.
- B If lamp Y breaks in circuit 2, both the other lamps will go out.
- C If lamp Y breaks in circuit 1, lamp Z will go out, but lamp X will remain on.
- D If lamp Y breaks in circuit 2, lamp Z will go out, but lamp X will remain on.

34 How is electricity transmitted over large distances and why is it transmitted in this way?

	how	why
A	at high voltage	for safety
B	at high voltage	to reduce energy loss
C	at low voltage	for safety
D	at low voltage	to reduce energy loss

35 In a cathode-ray tube, particles are given off from a hot cathode by thermionic emission.

Which particles are given off?

- A atoms
- B electrons
- C ions
- D protons

- 36 When the thermistor in the circuit below is heated, the lamp becomes brighter.

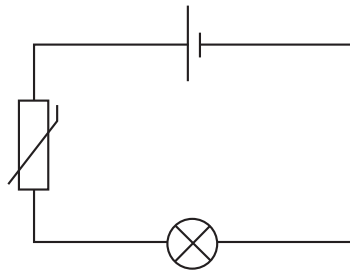

Why does this happen?

- A The resistance of the lamp decreases.
 B The resistance of the lamp increases.
 C The resistance of the thermistor decreases.
 D The resistance of the thermistor increases.
- 37 Which line in the table describes the nature of an α -particle and a γ -ray?

	α -particle	γ -ray
A	helium nucleus	electromagnetic radiation
B	helium nucleus	electron
C	proton	electromagnetic radiation
D	proton	electron

- 38 A radioactive nucleus R decays with the emission of a β -particle as shown.

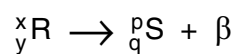

Which equation is correct?

- A $x = p$
 B $y = q$
 C $p = x - 1$
 D $q = y - 1$

39 Which line in the table shows the structure of the nucleus of a helium atom ${}^4_2\text{He}$?

	electrons	neutrons	protons
A	2	2	0
B	2	0	2
C	0	2	2
D	2	2	2

40 A nucleus of substance X has the symbol ${}^{26}_{12}\text{X}$.

How many electrons orbit around the nucleus of a neutral atom of substance X?

- A** 12
- B** 14
- C** 26
- D** 38

