

UNIVERSITY OF CAMBRIDGE INTERNATIONAL EXAMINATIONS
International General Certificate of Secondary Education

PHYSICS

0625/01

Paper 1 Multiple Choice (Core)

October/November 2005

45 minutes

Additional Materials: Multiple Choice Answer Sheet
Soft clean eraser
Soft pencil (type B or HB is recommended)

READ THESE INSTRUCTIONS FIRST

Write in soft pencil.
Do not use staples, paper clips, highlighters, glue or correction fluid.
Write your name, Centre number and candidate number on the Answer Sheet in the spaces provided unless this has been done for you.

There are **forty** questions on this paper. Answer **all** questions.
For each question there are four possible answers **A, B, C** and **D**. Choose the **one** you consider correct and record your choice in **soft pencil** on the separate Answer Sheet.

Read the instructions on the Answer Sheet very carefully.

Each correct answer will score one mark. A mark will not be deducted for a wrong answer.
Any rough working should be done in this booklet.

This document consists of **17** printed pages and **3** blank pages.



2

- 1 A measuring cylinder is used to measure the volume of a liquid.

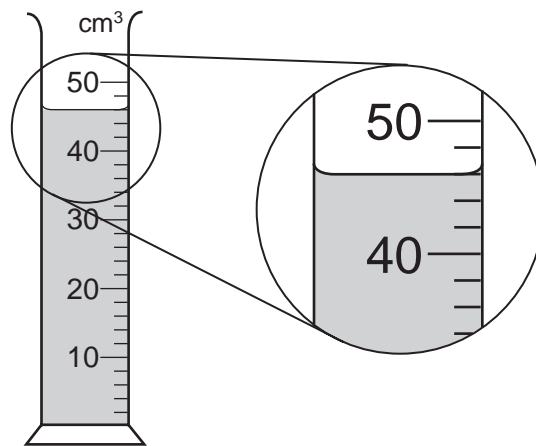

What is the volume of the liquid?

- A 43 cm³ B 46 cm³ C 48 cm³ D 54 cm³
- 2 The graph represents part of the journey of a car.

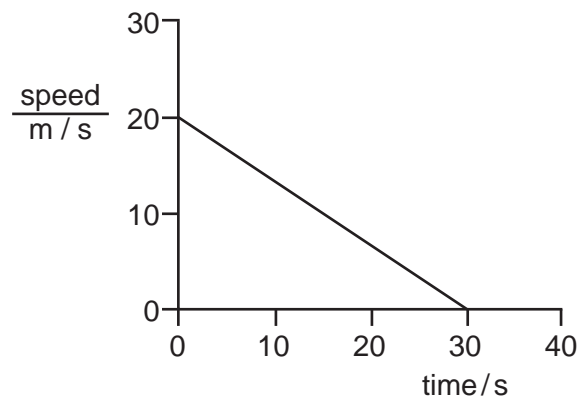

What distance does the car travel during this part of the journey?

- A 150 m B 300 m C 600 m D 1200 m
- 3 A man crosses a road 8.0 m wide at a speed of 2.0 m/s.

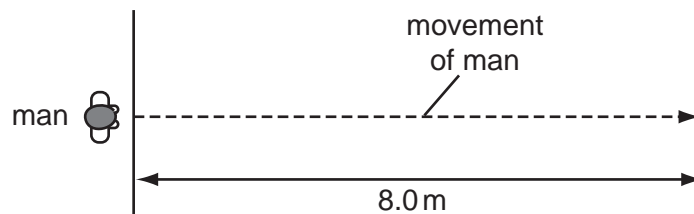

How long does the man take to cross the road?

- A 4.0 s B 6.0 s C 10 s D 16 s

- 4 What is the gravitational force that the Earth exerts on an object?
- A the density of the object
 - B the mass of the object
 - C the volume of the object
 - D the weight of the object

- 5 In an experiment, five identical bags of rice are balanced by a 10 kg mass.

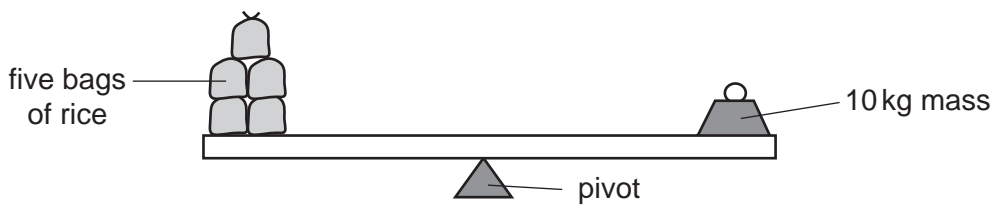

Two bags of rice are added to the other five.

What mass will now balance the bags?

- A 3.5 kg
- B 7.0 kg
- C 10 kg
- D 14 kg

- 6 The same mass of four different liquids is placed in some measuring cylinders.

Which measuring cylinder contains the liquid with the greatest density?

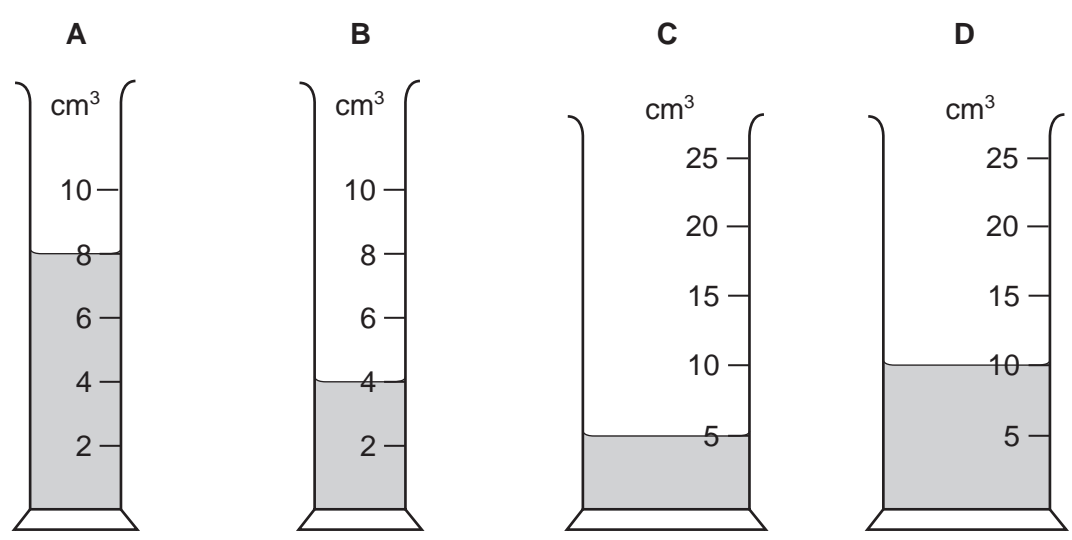

- 7 The diagram shows a flat metal plate that may be hung from a nail so that it can rotate about four holes.

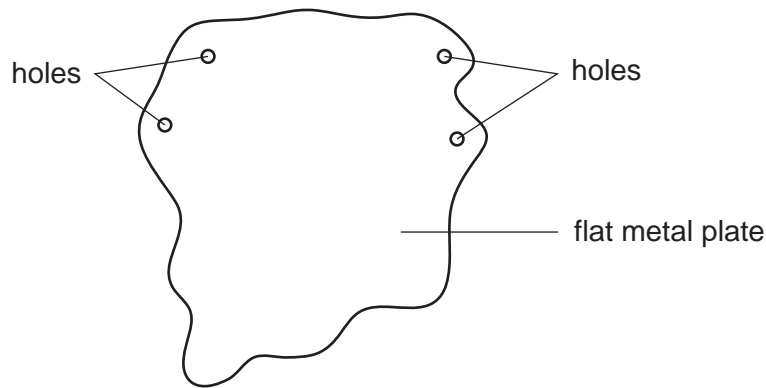

What is the smallest number of holes from which the flat metal plate should be hung in order to find its centre of gravity?

- A 1 B 2 C 3 D 4

- 8 Two equal forces F act on each of four planks.

Which plank turns?

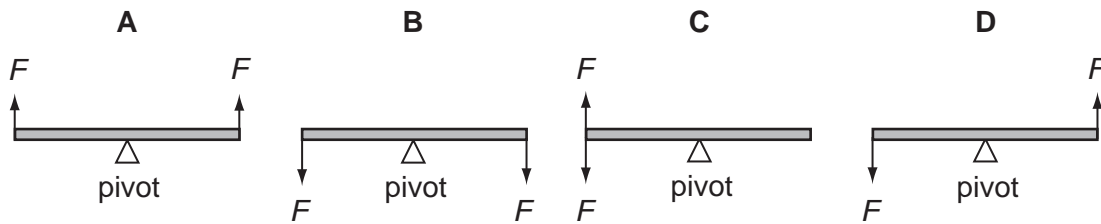

- 9 Which type of power station does **not** use steam from boiling water to generate electricity?
- A geothermal
B hydroelectric
C nuclear
D oil-fired

10 A man standing at the top of a cliff throws a stone.

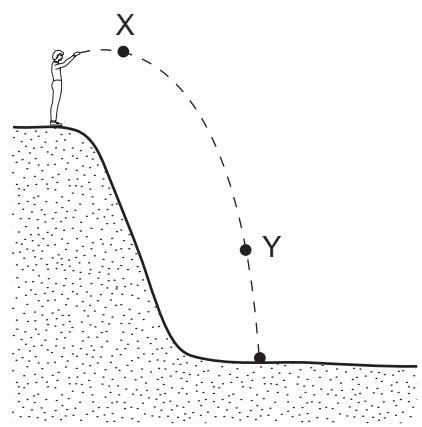

Which forms of energy does the stone have at X and at Y?

	energy at X	energy at Y
A	gravitational only	kinetic only
B	kinetic only	gravitational only
C	gravitational only	gravitational and kinetic
D	gravitational and kinetic	gravitational and kinetic

11 Four blocks, each weighing 10 N, rest on a horizontal table.

Which block applies the greatest pressure on the table?

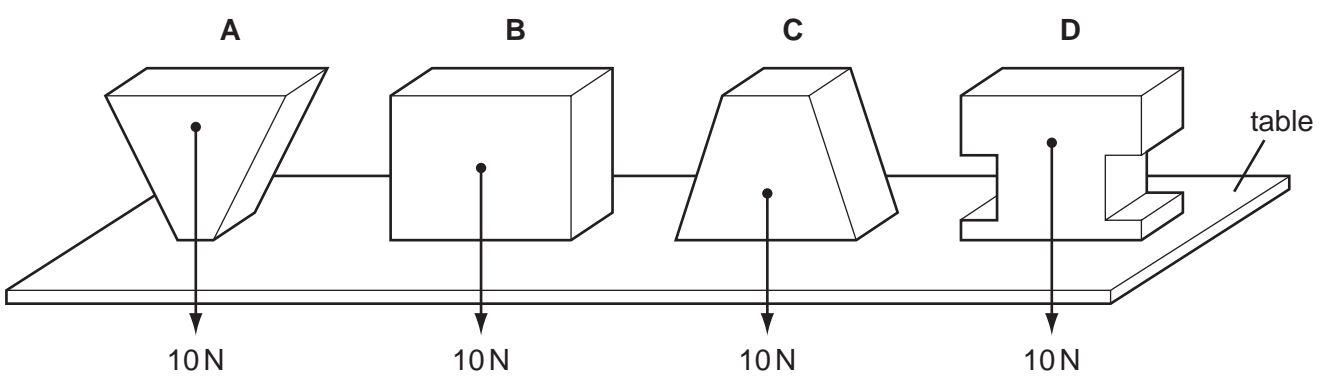

12 The diagram shows a mercury barometer.

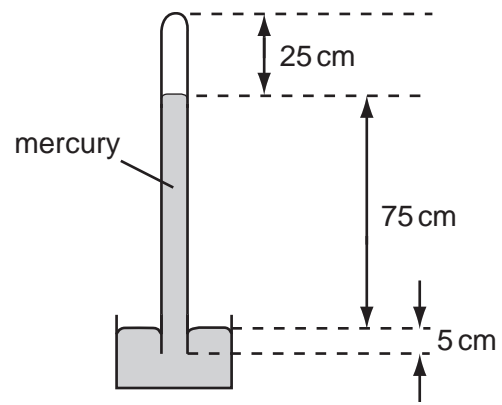

Which distance is used to calculate the pressure of the atmosphere?

- A 25 cm
- B 75 cm
- C 80 cm
- D 100 cm

13 A drop of liquid falls on a student's skin and quickly evaporates.

What is the effect on the skin and the reason?

- A The skin cools because the most energetic molecules escape from the liquid.
- B The skin cools because the most energetic molecules remain in the liquid.
- C The skin warms because the most energetic molecules escape from the liquid.
- D The skin warms because the most energetic molecules remain in the liquid.

14 A suspension of pollen grains in water is observed under a microscope. The pollen grains are seen to be moving all the time.

Which diagram illustrates this motion?

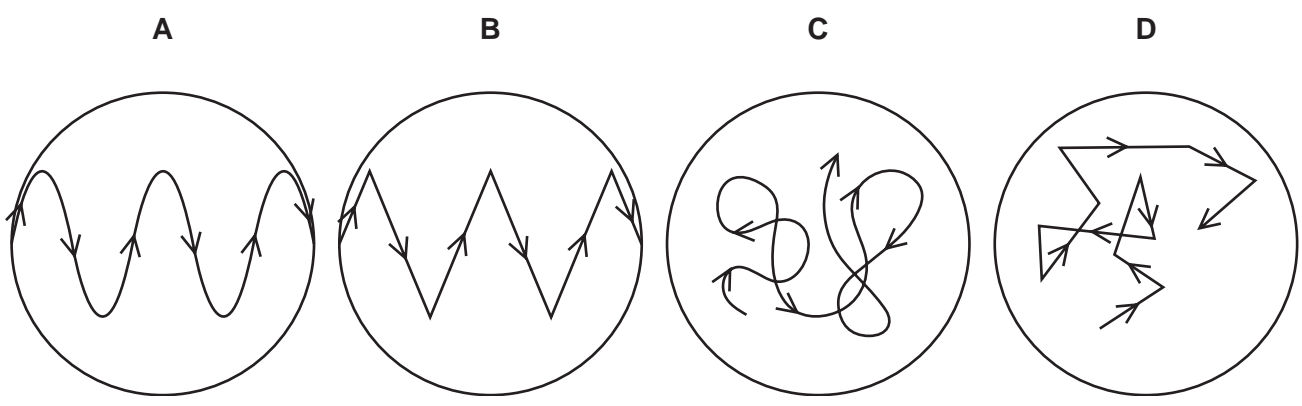

- 15 A knife is being sharpened on a rotating sharpening-stone. A spark flies off and hits the operator's hand. The spark is a very hot, very small piece of metal. The operator feels no pain.

What does this show about the piece of metal?

- A It has a high thermal capacity.
B It has a low thermal capacity.
C It is a good conductor of heat.
D It is a poor conductor of heat.
- 16 Which substance is a liquid at a room temperature of 25°C?

substance	melting point/°C	boiling point/°C
A	-218	-183
B	-39	357
C	44	280
D	119	444

- 17 The diagram shows a cooling unit in a refrigerator.

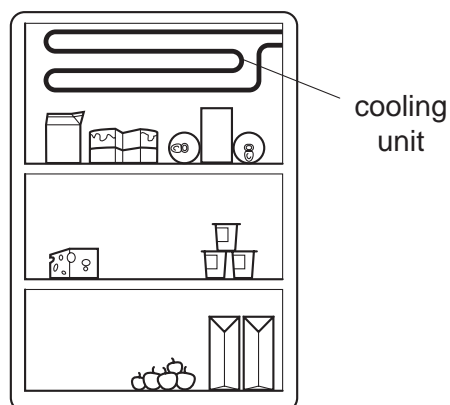

Why is the cooling unit placed at the top?

- A Cold air falls and warm air is displaced upwards.
B Cold air is a bad conductor so heat is not conducted into the refrigerator.
C Cold air is a good conductor so heat is conducted out of the refrigerator.
D Cold air stops at the top and so prevents convection.

18 How does heat from the Sun reach the Earth?

- A conduction only
- B convection only
- C radiation only
- D conduction, convection and radiation

19 The diagrams show four sources of waves.

Which source generates longitudinal waves?

A



stick pushed up and down in water

B

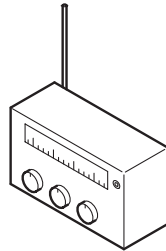

radio transmitter

C

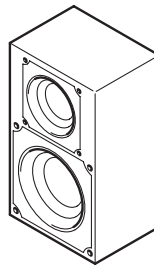

loudspeaker

D

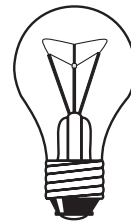

lamp

20 In a ripple tank, water waves move towards a barrier with a narrow gap.

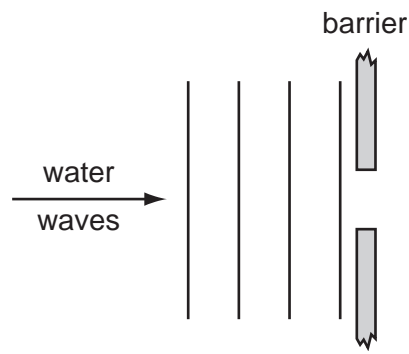

Which diagram best shows the waves beyond the barrier?

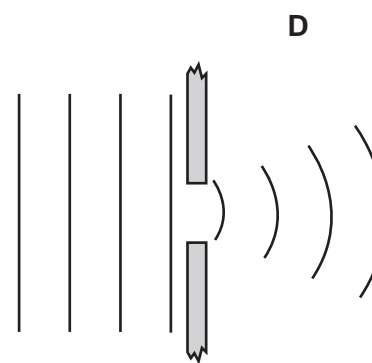
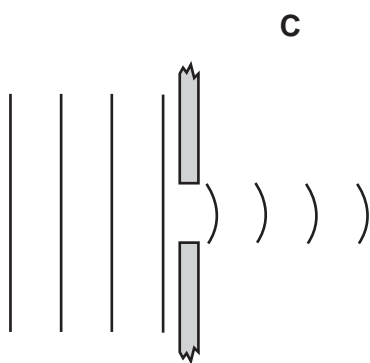
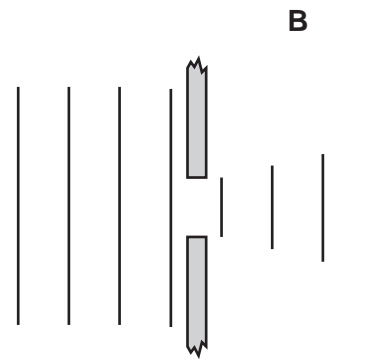
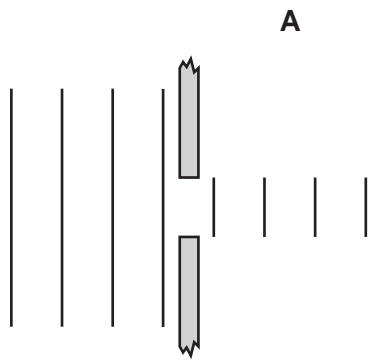

21 A ray of light passes from glass into air at an angle of incidence of 40° . The glass has a refractive index of 1.5 and the air has a refractive index of 1.0.

Which diagram shows what happens to the ray?

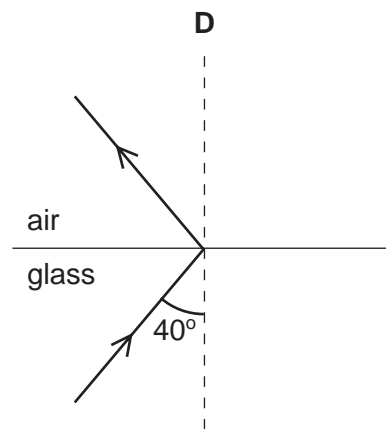
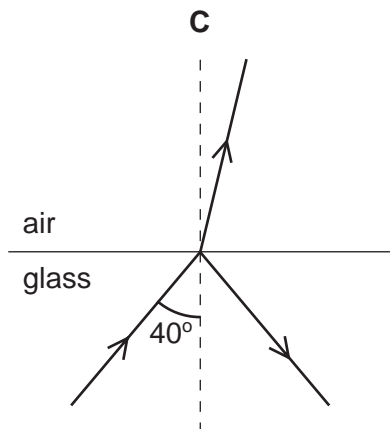
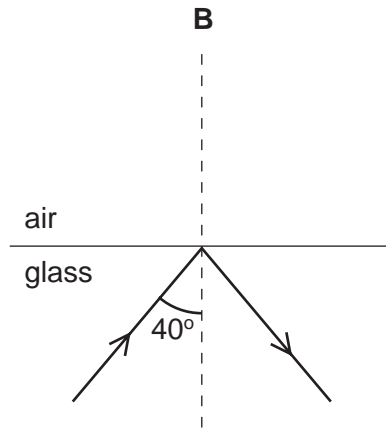
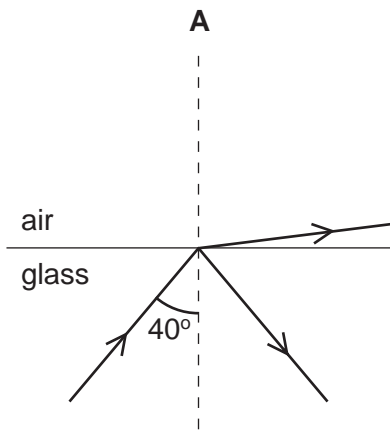

22 Rays of light enter and leave a box.

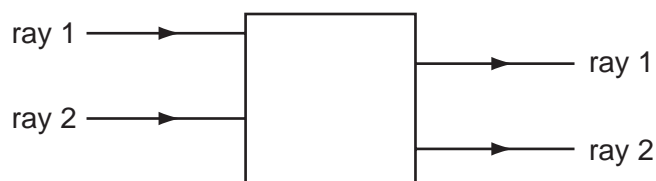

What could be inside the box to make the rays behave as shown?

- A a converging lens
- B a parallel-sided glass block
- C a plane mirror
- D a triangular prism

- 23 A thin converging lens is used to produce, on a screen, a focused image of a candle.

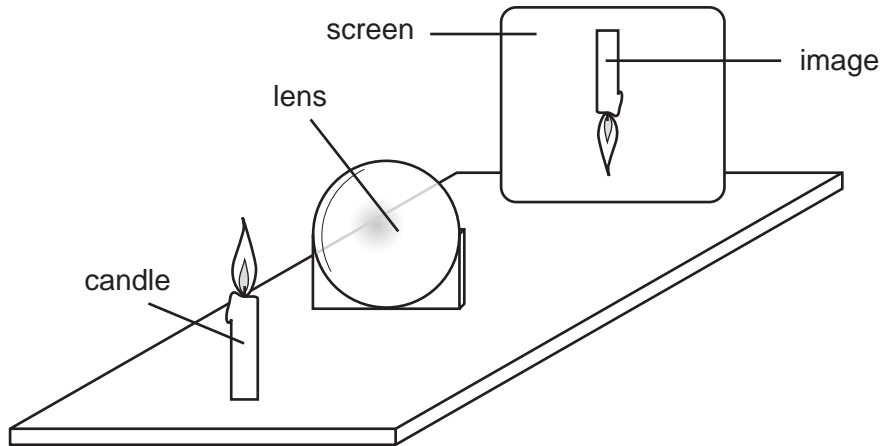

The screen and the lens are moved back and forth and various focused images are produced on the screen.

Which statement is **always** true?

- A The image is at the principal focus (focal point) of the lens.
 - B The image is bigger than the object.
 - C The image is closer to the lens than the object is.
 - D The image is inverted.
- 24 Two astronauts without radios can only communicate in space if their helmets are touching. There is no air in space.

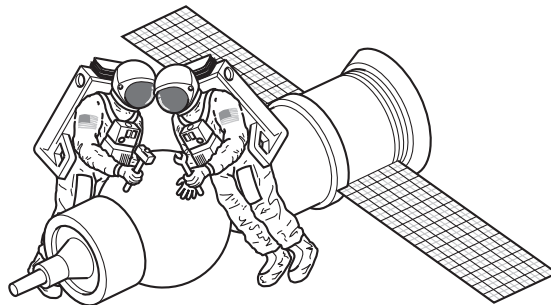

What does this show about sound?

	through a solid	through a vacuum
A	can travel	can travel
B	can travel	cannot travel
C	cannot travel	can travel
D	cannot travel	cannot travel

- 25 When the horn on a ship is sounded, the passengers hear an echo from a cliff after 4 s.
If the speed of sound is 340 m/s, how far away is the cliff?

A 170 m B 340 m C 680 m D 1360 m

- 26 How many of the following methods could be used to demagnetise a piece of steel?

heating it until it is red hot

pulling it from a coil that is carrying an alternating current

placing it in an east-west direction and hammering it

putting it in a coil which is carrying a direct current

A 1 B 2 C 3 D 4

- 27 Two rods X and Y look the same.

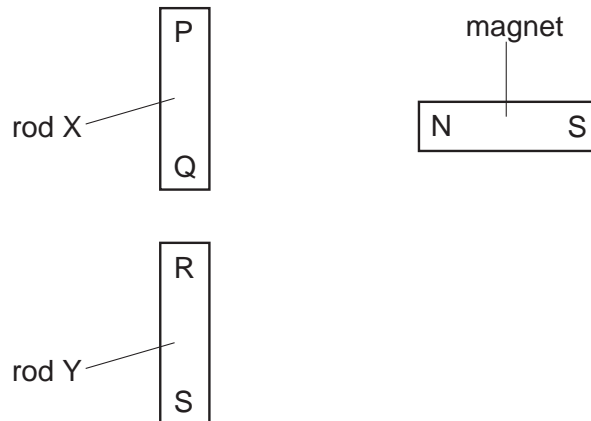

The N pole of a magnet is brought close, in turn, to each end of both rods. The results of these four actions are shown in the table.

end tested	result
P	attraction
Q	attraction
R	attraction
S	repulsion

Which of the rods is a permanent magnet?

- A neither of the rods
B both of the rods
C rod X only
D rod Y only

28 Which circuit should be used to find the resistance of a lamp?

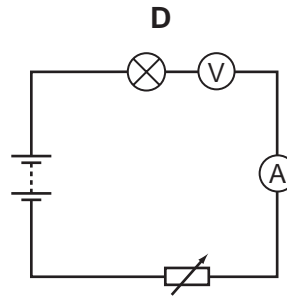
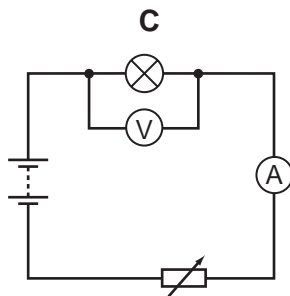
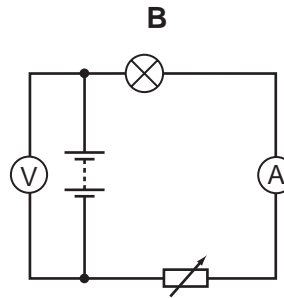
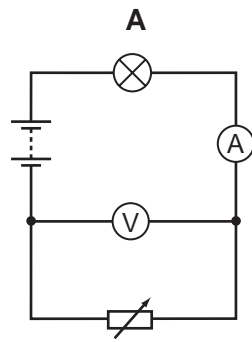

29 The table shows the voltage and current ratings for four electric heaters.

Which heater has the least resistance?

	voltage / V	current / A
A	110	5.0
B	110	10
C	230	5.0
D	230	10

30 Which component can store energy for use in time delay circuits?

- A** capacitor
- B** potentiometer
- C** resistor
- D** thermistor

- 31 When the circuit shown is connected with switch S open, the 6 V lamp glows.

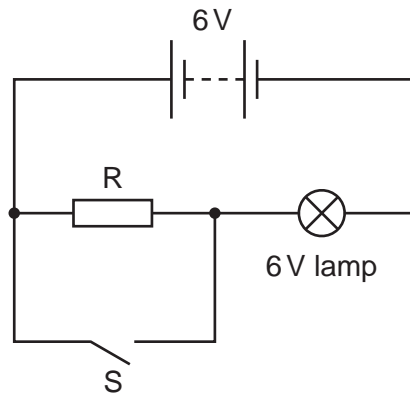

What happens to the brightness of the lamp when switch S is closed?

- A It becomes brighter.
 - B It remains the same.
 - C It becomes dimmer.
 - D It goes off.
- 32 Why are the electric lamps in a house lighting circuit normally connected in parallel?
- A The current in every circuit must be the same.
 - B The lamps are always switched on and off at the same time.
 - C The voltage across each lamp must be the mains voltage.
 - D When one of the lamps blows, all the others go out.
- 33 In the circuit shown, one of the fuses blows and all the lamps go out.

Which fuse blows?

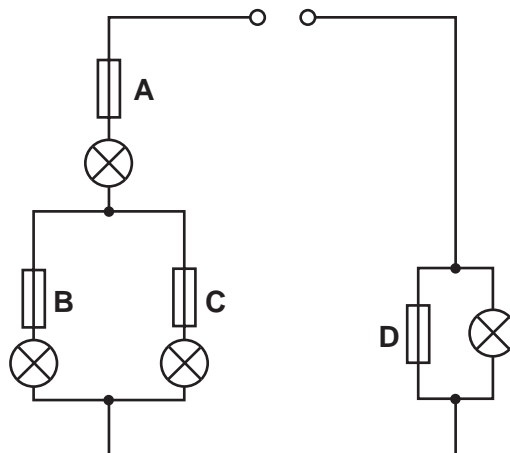

34 Which arrangement may be used to step up a voltage?

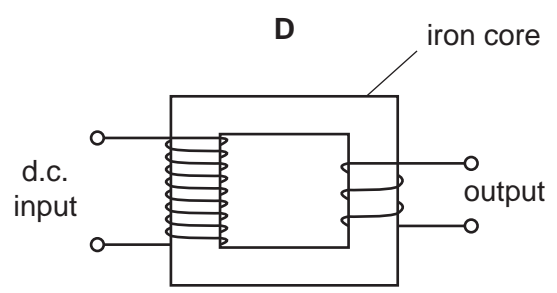
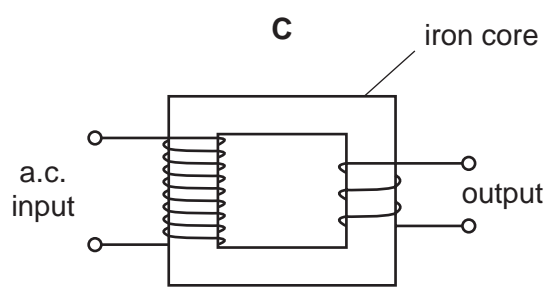
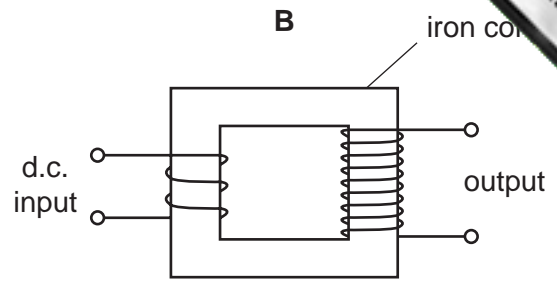
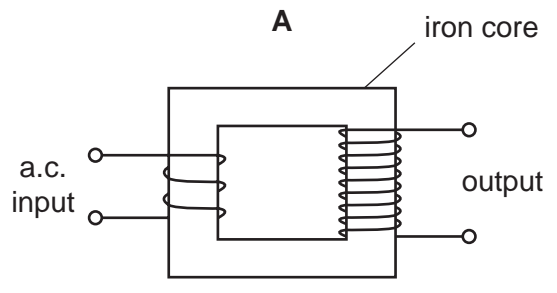

35 The diagrams show a straight wire carrying a current into the paper.

Which diagram shows the magnetic field pattern due to this current?

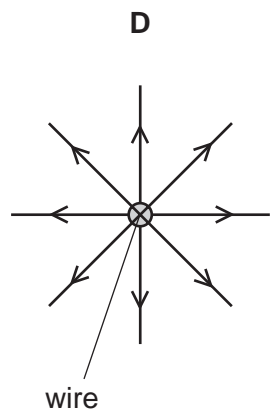
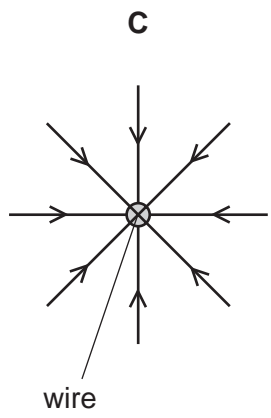
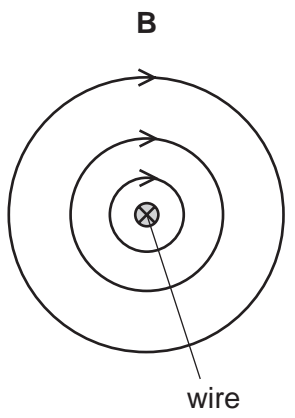
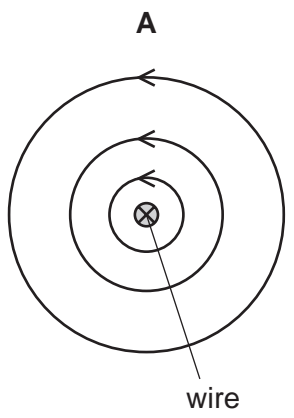

36 A magnet is suspended from a spring so that it can move freely inside a coil which is connected to a sensitive centre-zero ammeter.

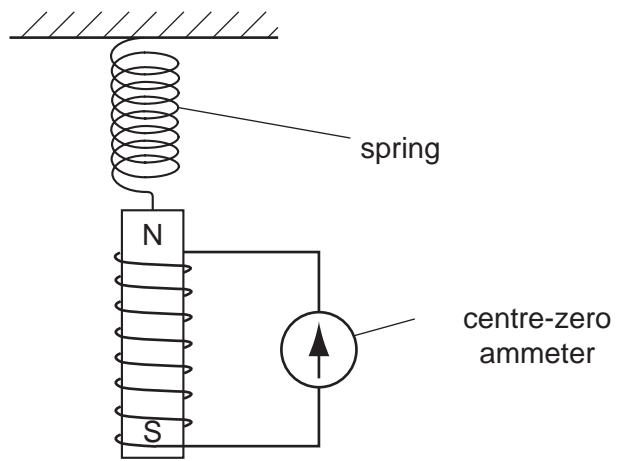

What does the ammeter show when the magnet vibrates slowly up and down?

- A a reading constantly changing from left to right and right to left
- B a steady reading to the left
- C a steady reading to the right
- D a steady zero reading

37 Charged particles are emitted from the cathode of an oscilloscope.

What is the name and the charge of these particles?

	name of particles	charge of particles
A	electrons	negative
B	electrons	positive
C	protons	negative
D	protons	positive

- 38 A radioactive source emits radiation that can pass through a sheet of paper but not aluminium.

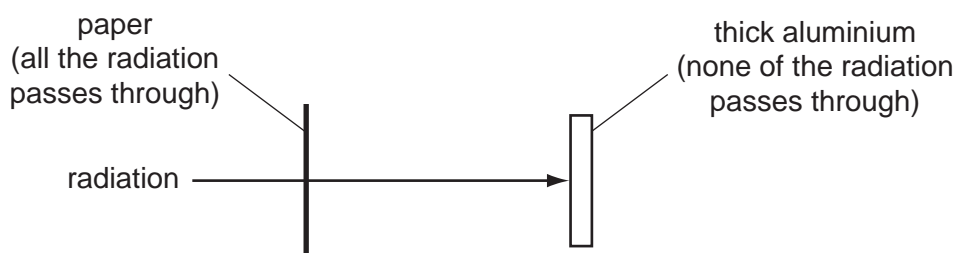

What does this show about the radiation?

- A** It is α -particles.
B It is β -particles.
C It is γ -rays.
D It is a mixture of α -particles and γ -rays.
- 39 An unstable nucleus has 145 neutrons and 92 protons. It emits a β -particle.

How many neutrons and protons does the nucleus have after emitting the β -particle?

	neutrons	protons
A	144	92
B	144	93
C	145	91
D	145	93

- 40 Which particles are found in the nucleus of an atom?

- A** neutrons and protons only
B neutrons only
C protons and electrons only
D protons, electrons and neutrons

