



UNIVERSITY OF CAMBRIDGE INTERNATIONAL EXAMINATIONS  
International General Certificate of Secondary Education

CANDIDATE  
NAME

CENTRE  
NUMBER

--	--	--	--	--

CANDIDATE  
NUMBER

--	--	--	--



**PHYSICS**

**0625/06**

Paper 6 Alternative to Practical

**October/November 2009**

**1 hour**

Candidates answer on the Question Paper.

No Additional Materials are required.

**READ THESE INSTRUCTIONS FIRST**

Write your Centre number, candidate number and name on all the work you hand in.

Write in dark blue or black pen.

You may use a soft pencil for any diagrams, graphs or rough working.

Do not use staples, paper clips, highlighters, glue or correction fluid.

**DO NOT WRITE IN ANY BARCODES.**

Answer **all** questions.

At the end of the examination, fasten all your work securely together.

The number of marks is given in brackets [ ] at the end of each question or part question.

For Examiner's Use	
1	
2	
3	
4	
5	
<b>Total</b>	

This document consists of **14** printed pages and **2** blank pages.



1 The IGCSE class is investigating the period of oscillation of a simple pendulum.

Fig. 1.1 shows the set-up.

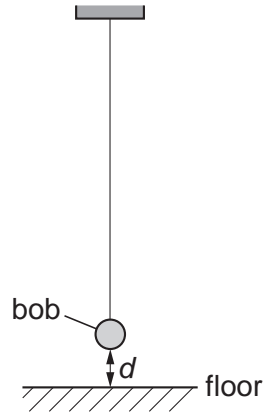

Fig. 1.1

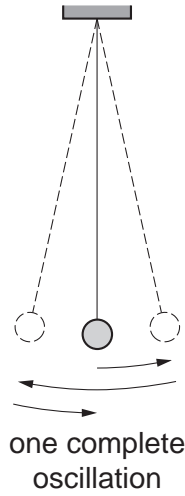

Fig. 1.2

(a) (i) On Fig. 1.1, measure the vertical distance  $d$  from the floor to the bottom of the pendulum bob.

$d = \dots\dots\dots$

(ii) Fig. 1.1 is drawn one twentieth actual size. Calculate the actual distance  $x$  from the floor to the bottom of the pendulum bob. Enter this value in the top row of Table 1.1.

The students displace the pendulum bob slightly and release it so that it swings. They measure and record in Table 1.1 the time  $t$  for 20 complete oscillations of the pendulum (see Fig. 1.2).

Table 1.1

$x/cm$	$t/s$	$T/s$	$T^2/s^2$
	20.0		
20.0	19.0		
30.0	17.9		
40.0	16.8		
50.0	15.5		

(b) (i) Calculate the period  $T$  of the pendulum for each set of readings. The period is the time for one complete oscillation. Enter the values in Table 1.1.

(ii) Calculate the values of  $T^2$ . Enter the  $T^2$  values in Table 1.1.

(c) Use your values from Table 1.1 to plot a graph of  $T^2/s^2$  ( $y$ -axis) against  $x/cm$  ( $x$ -axis). Draw the best-fit line.

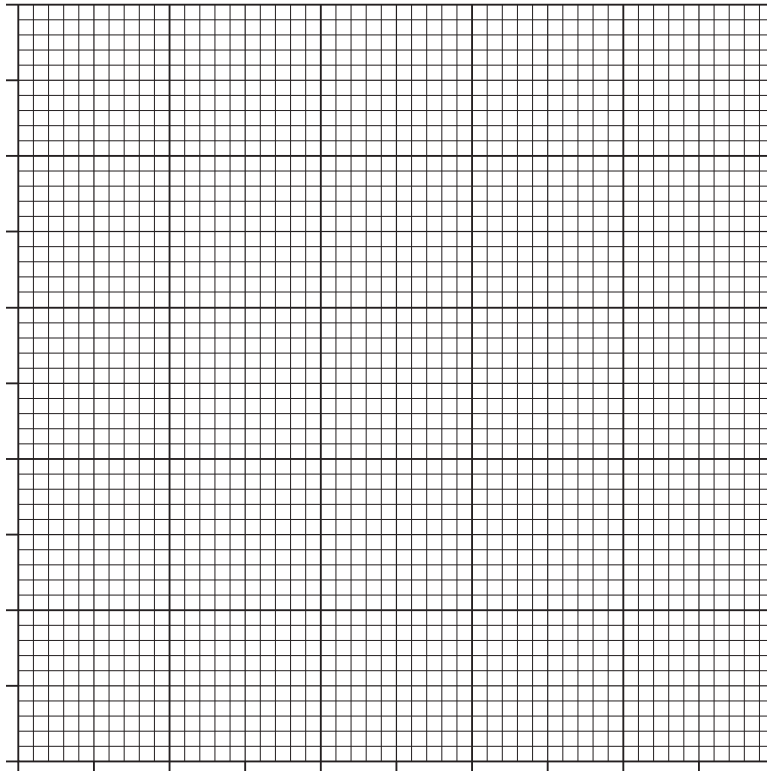

4

(d) State whether or not your graph shows that  $T^2$  is directly proportional to  $x$ . Justify your statement by reference to the graph.

statement .....

justification .....

..... [1]

[Total: 10]



- 2 An IGCSE student is investigating the cooling of thermometer bulbs under different conditions.

He places a thermometer in a beaker of hot water and records the temperature  $\theta_h$  of the hot water.

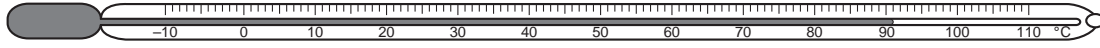

**Fig. 2.1**

- (a) Fig. 2.1 shows the thermometer. Write down the value of  $\theta_h$  that it shows.

$\theta_h$  ..... [1]

He then moves the thermometer until the thermometer bulb is just above the surface of the water (position **A**) and immediately starts a stopclock.

He records the time  $t$  and the temperature reading  $\theta$  every 30s. The readings are shown in Table 2.1.

**Table 2.1**

	<b>Position A</b>	<b>Position B</b>
$t/$	$\theta/$	$\theta/$
30	65	56
60	58	47
90	54	40
120	52	35
150	50	32
180	48	30

- (b) Complete the column headings in the table.

[1]

The student replaces the thermometer in the hot water and then moves the thermometer 15 cm away from the beaker to position **B** and immediately starts the stopclock. He records the time  $t$  and the temperature reading  $\theta$  every 30 s. The readings are shown in Table 2.1.

(c) State in which position the thermometer bulb cooled more quickly. Justify your answer by reference to the readings.

statement .....

justification .....

..... [1]

(d) To make a fair comparison between the rates of cooling of the thermometer bulbs in the two positions, it is important to control other experimental conditions. Suggest two conditions that should be controlled in this experiment.

1. ....

2. .... [2]

[Total: 5]

- 3 The IGCSE class is comparing the combined resistance of lamps arranged either in series or in parallel.

The circuit shown in Fig. 3.1 is used.

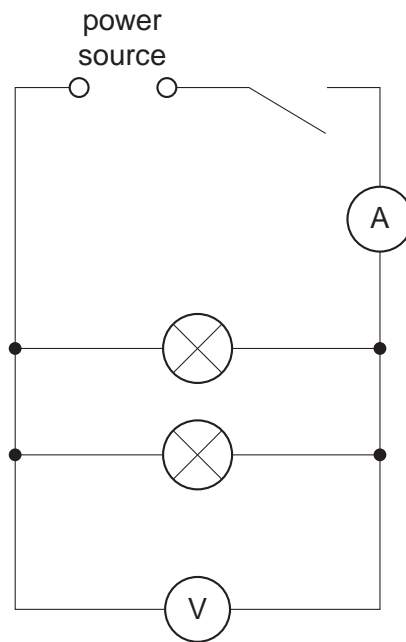

Fig. 3.1

A student measures and records the current  $I$  in the circuit and the p.d.  $V$  across the two lamps.

Fig. 3.2 shows the readings on the two meters.

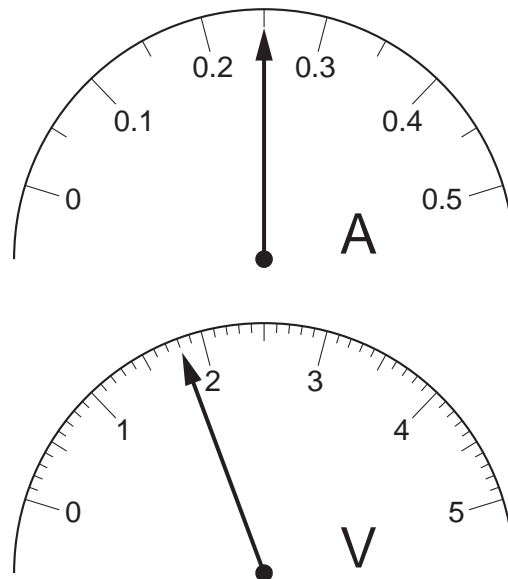

Fig. 3.2



- (a) (i) Write the voltage and current readings in Table 3.1, below.  
 (ii) Complete the column headings in Table 3.1.

[3]

- (b) The student then sets up the circuit shown in Fig. 3.3 and records the readings. These readings have already been entered in Table 3.1.

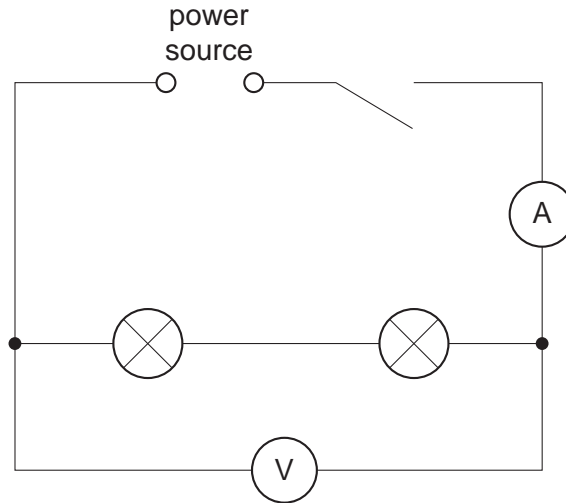

Fig. 3.3

For each set of readings in the table, calculate the combined resistance  $R$  of the two lamps using the equation  $R = V/I$ . Record the values of  $R$  in Table 3.1. [2]

Table 3.1

	$V/$	$I/$	$R/$
Circuit of Fig. 3.1			
Circuit of Fig. 3.3	1.8	0.52	

- (c) Using the values of resistance you have obtained, calculate the ratio  $y$  of the resistances using the equation

$$y = \frac{\text{resistance of lamps in series}}{\text{resistance of lamps in parallel}}$$

$y = \dots\dots\dots$

[2]

(d) Fig. 3.4 shows a circuit including two motors A and B.

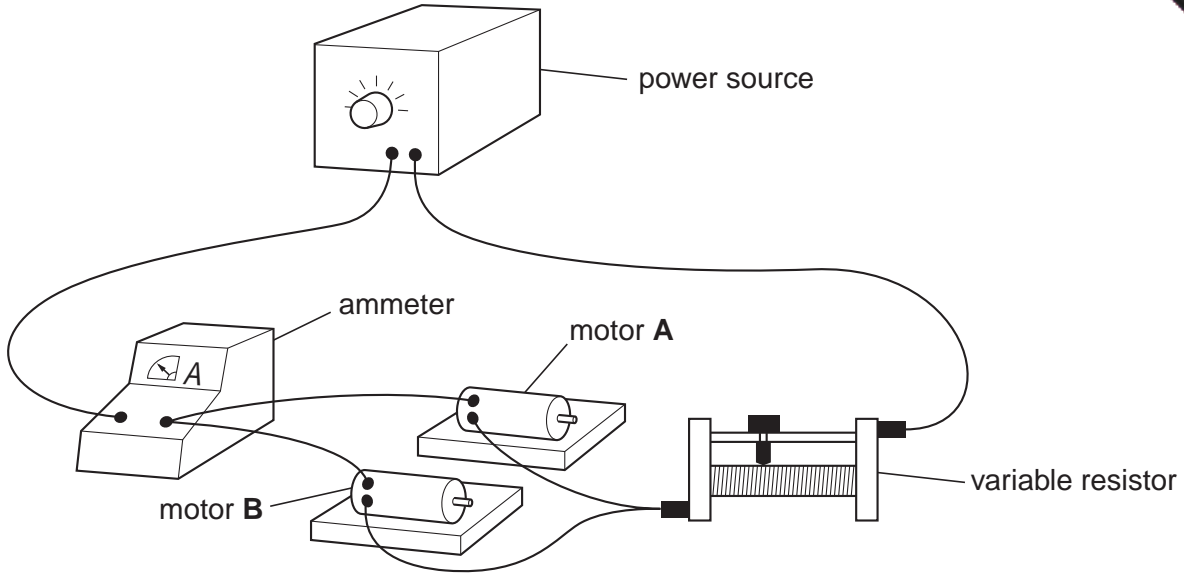
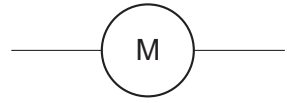

Fig. 3.4

(i) Draw a diagram of the circuit using standard circuit symbols. The circuit symbol for a motor is:



(ii) An engineer wishes to measure the voltage across motor A.

1. On Fig. 3.4, mark with the letters **X** and **Y** where the engineer should connect the voltmeter.
2. State the purpose of the variable resistor.

.....  
.....

[3]

[Total: 10]

4 An IGCSE student is determining the focal length of a lens by two different methods.

The set-up for Method 1 is shown in Fig. 4.1.

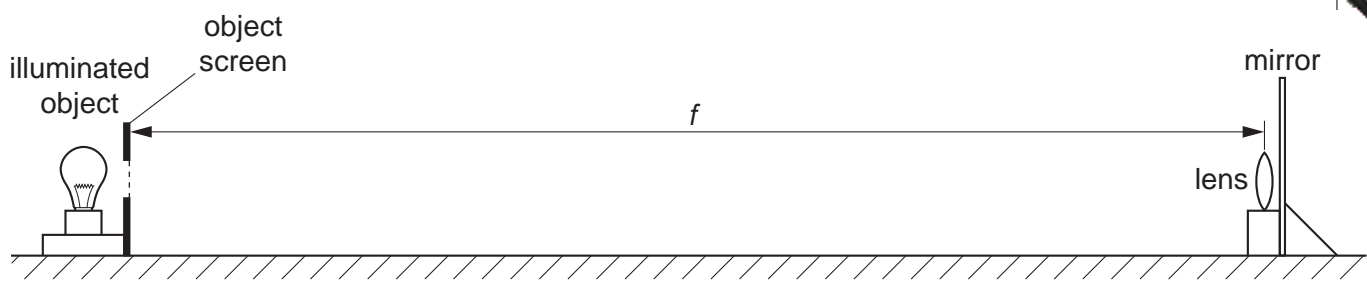

Fig. 4.1

The student moves the lens and the mirror slowly towards the object screen until a sharply focused image is obtained on the object screen as shown in Fig. 4.2.

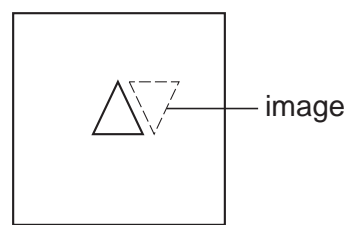

Fig. 4.2

(a) On Fig. 4.1, use your rule to measure the distance  $f$  between the lens and the object screen. This is the focal length of the lens.

$f = \dots\dots\dots$  [2]

(b) For Method 2, the student takes measurements of the diameter  $d$  and maximum thickness  $t$  of the lens. Use your rule to take measurements on Fig. 4.3.

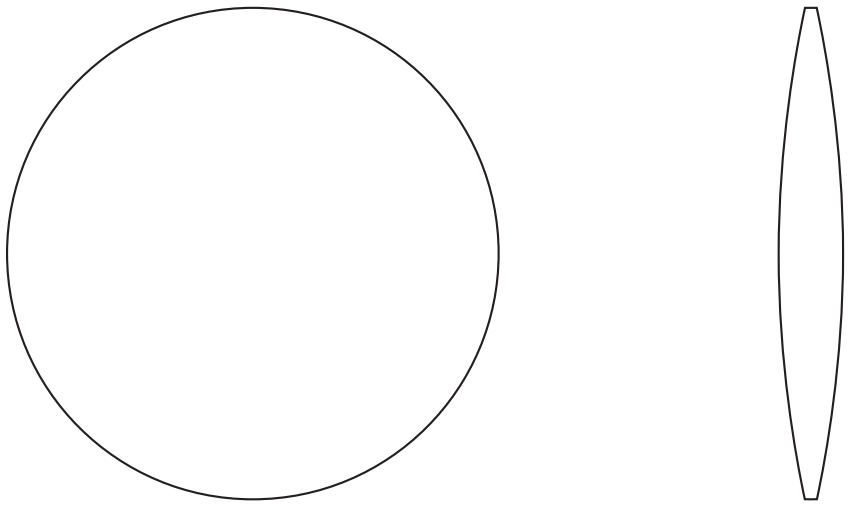

Fig. 4.3

(i) Determine an average value for the diameter  $d$  of the lens. Record your reading in the space below.

$d = \dots\dots\dots$

(ii) Measure the maximum thickness  $t$  of the lens.

$t = \dots\dots\dots$

(iii) Draw a diagram to show how, in the laboratory you would use two rectangular blocks of wood and a metre rule to measure the thickness of the lens as accurately as possible.

(iv) Theory shows that, for a perfectly formed lens, the focal length is given by the formula

$$f = \frac{d^2}{kt} \quad \text{where } k = 4.16.$$

Calculate the focal length  $f$  of the lens using this formula.

$f = \dots\dots\dots$

[7]

(c) Explain whether your results from Methods 1 and 2 support the theory in part (b)

.....  
.....  
..... [1]

[Total: 10]

5 An IGCSE student is carrying out an optics experiment.

The experiment involves using a lens to focus the image of an illuminated object onto a screen.

(a) Complete the diagram below to show the apparatus you would use. Include a metre rule to measure the distances between the object and the lens and between the lens and the screen. The illuminated object is drawn for you.

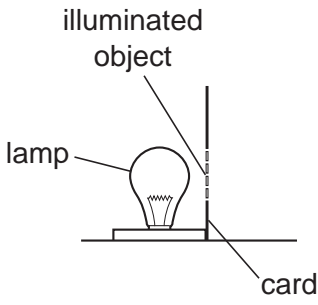

[3]

(b) State two precautions that you would take to obtain accurate results in this experiment.

- 1. ....
- 2. ....

[2]

[Total: 5]

