



UNIVERSITY OF CAMBRIDGE INTERNATIONAL EXAMINATIONS
International General Certificate of Secondary Education

PHYSICS

0625/13

Paper 1 Multiple Choice

October/November 2010

45 minutes

Additional Materials: Multiple Choice Answer Sheet
Soft clean eraser
Soft pencil (type B or HB recommended)

* 9 8 0 7 7 2 5 6 6 7 *

READ THESE INSTRUCTIONS FIRST

Write in soft pencil.

Do not use staples, paper clips, highlighters, glue or correction fluid.

Write your name, Centre number and candidate number on the Answer Sheet in the spaces provided unless this has been done for you.

There are **forty** questions on this paper. Answer **all** questions. For each question there are four possible answers **A, B, C** and **D**.

Choose the **one** you consider correct and record your choice in **soft pencil** on the separate Answer Sheet.

Read the instructions on the Answer Sheet very carefully.

Each correct answer will score one mark. A mark will not be deducted for a wrong answer. Any rough working should be done in this booklet.

This document consists of **18** printed pages and **2** blank pages.



2

- 1 A student is trying to find the density of water and of a large, regularly shaped concrete block. Which apparatus is needed to find the density of **both** the water and the concrete block?

- A balance, clock, measuring cylinder
- B balance, clock, ruler
- C balance, measuring cylinder, ruler
- D clock, measuring cylinder, ruler

- 2 Liquid X has a density of 1010 kg/m^3 . Liquid Y has a density of 950 kg/m^3 .

The liquids are poured into tubes as shown.

Which tube has the greatest pressure on its base?

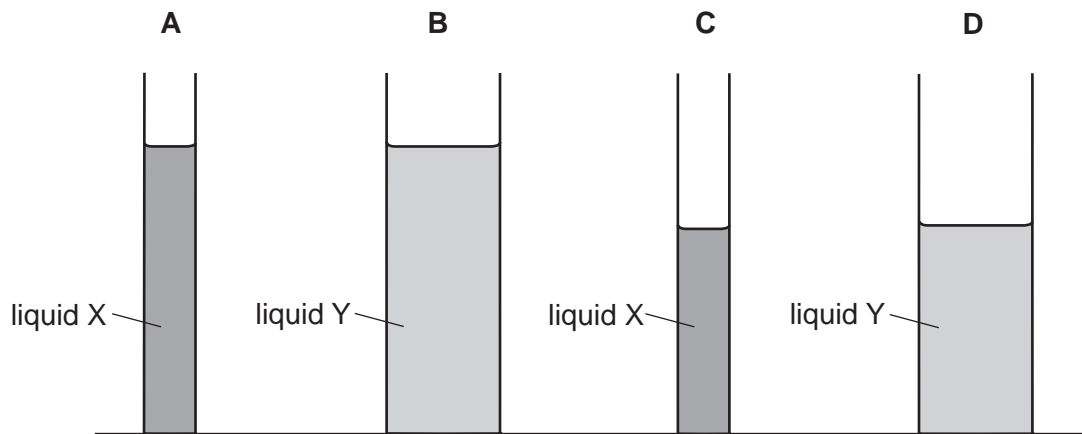

- 3 What is a simple mercury barometer designed to measure?

- A the pressure beneath a liquid
- B the pressure of a gas supply
- C the pressure of car tyres
- D the pressure of the atmosphere

4 The diagrams show an experiment to determine the volume of a stone.

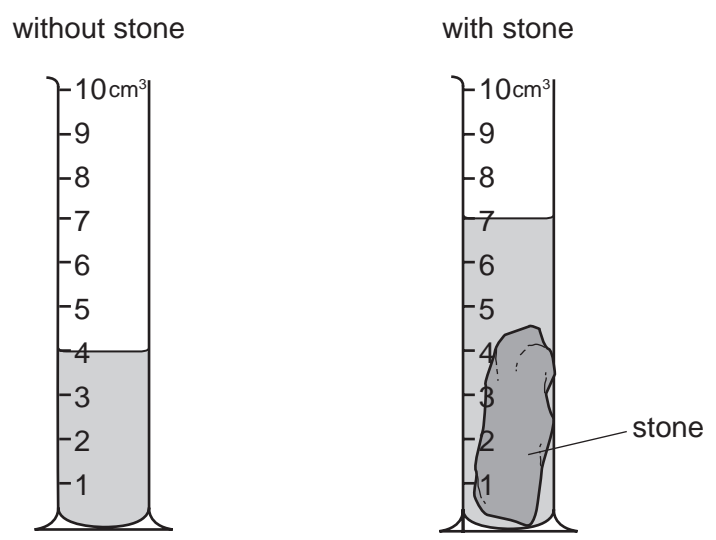

What is the volume of the stone?

- A 3 cm³
- B 4 cm³
- C 7 cm³
- D 11 cm³

5 The reading on a spring balance with a holder and eight identical discs is 3.0 N.

Six discs are removed and the reading becomes 1.2 N.

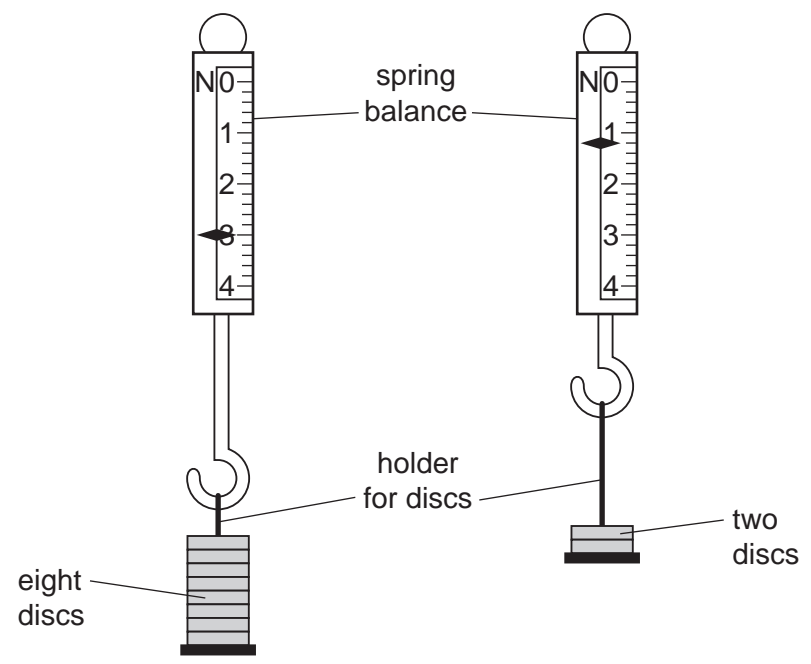

What is the weight of one disc?

- A 0.2 N
- B 0.3 N
- C 0.5 N
- D 0.6 N

4

- 6 The extension/load graph for a spring is shown. The unloaded length of the spring is

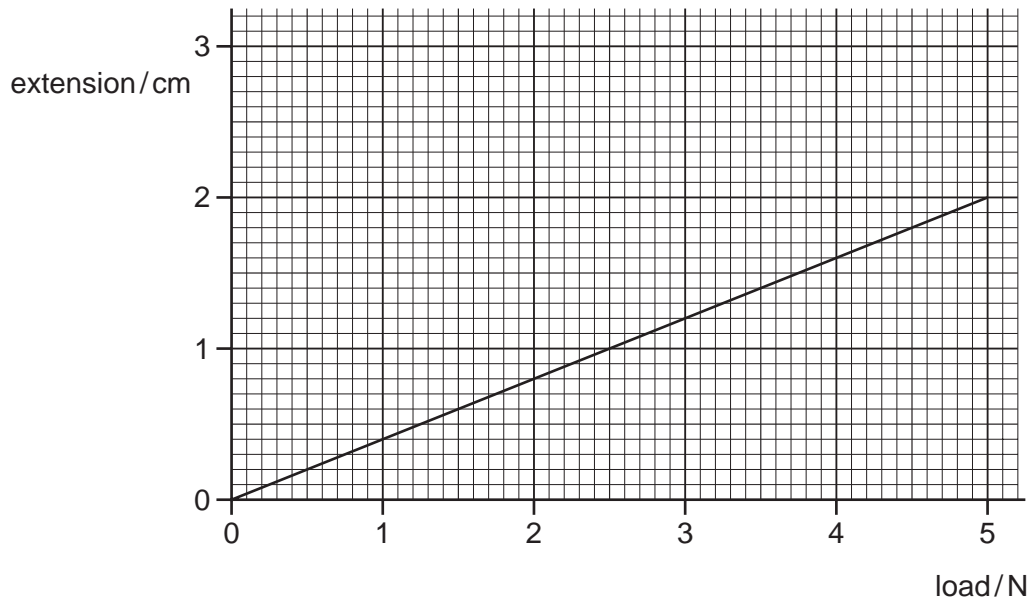

When an object of unknown weight is hung on the spring, the length of the spring is 16.4 cm.

What is the weight of the object?

- A** 0.55 N **B** 0.67 N **C** 3.5 N **D** 4.1 N
- 7 Four athletes run twice around a track. The table shows their times at the end of each lap.

Which athlete runs the second lap the fastest?

athlete	time at end of first lap / s	time at end of second lap / s
A	22.99	47.04
B	23.04	47.00
C	23.16	47.18
D	23.39	47.24

5

- 8 A car travels along the route PQRST in 30 minutes.

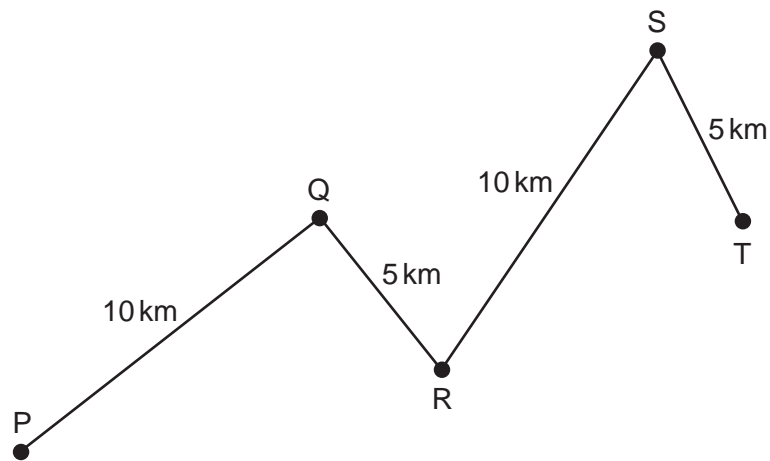

What is the average speed of the car?

- A** 10 km/hour **B** 20 km/hour **C** 30 km/hour **D** 60 km/hour
- 9 The diagram shows the speed/time graph for an object moving at constant speed.

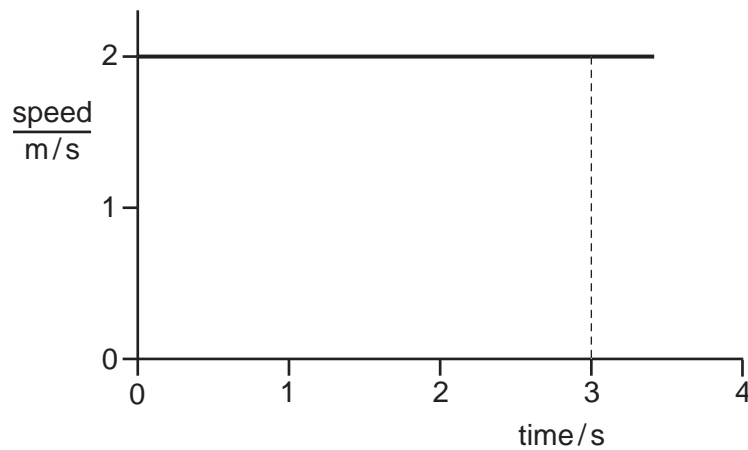

What is the distance travelled by the object in the first 3 s?

- A** 1.5 m **B** 2.0 m **C** 3.0 m **D** 6.0 m
- 10 Which list contains the name of a force?

- A** acceleration, charge, temperature
B density, resistance, speed
C distance, frequency, mass
D energy, power, weight

11 A force acts on a moving rubber ball.

Which of these changes could **not** happen to the ball because of the force?

- A a change in direction
- B a change in mass
- C a change in shape
- D a change in speed

12 A car is driven on a long journey along a flat, horizontal road. The car stops several times on the journey and its engine becomes hot.

Which type of energy does **not** change during the journey?

- A the chemical energy in the fuel tank
- B the gravitational energy of the car
- C the internal (thermal) energy of the engine
- D the kinetic energy of the car

13 Which of these is designed to change electrical energy into kinetic energy?

- A a capacitor
- B a generator
- C a motor
- D a transformer

14 An electric heater is placed inside a metal box which has one side open. The diagram shows four possible positions for the box.

The heater is switched on for several minutes.

In which position does the box become the hottest?

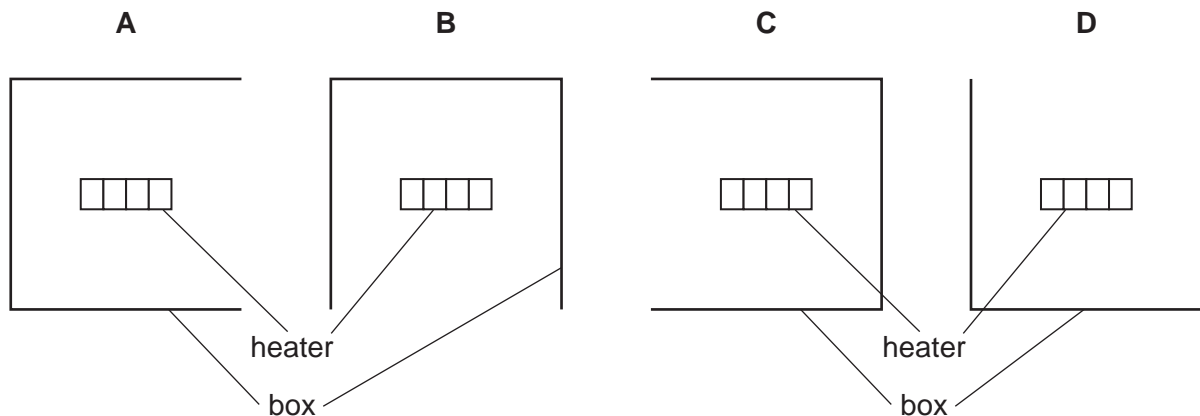

15 Some gas in a sealed plastic bag is cooled.

How do the gas molecules behave when this happens?

- A They move more quickly and become closer together.
- B They move more quickly and become further apart.
- C They move more slowly and become closer together.
- D They move more slowly and become further apart.

16 Which change is condensation?

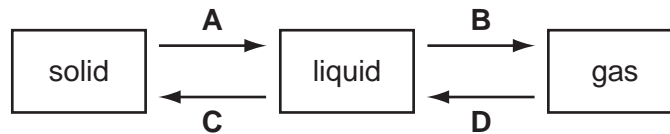

17 A block of ice cream is prevented from melting by wrapping it in newspaper soaked in water. The water evaporates from the newspaper.

Which molecules escape from the water and what happens to the average speed of the water molecules that remain in the newspaper?

	escaping molecules	average speed of the remaining water molecules
A	the more energetic ones	decreases
B	the more energetic ones	increases
C	the less energetic ones	decreases
D	the less energetic ones	increases

18 A beaker containing ice and a thermometer is left in a warm room for 15 minutes.

No water is visible in the beaker until 5 minutes has passed. After 15 minutes some ice is visible.

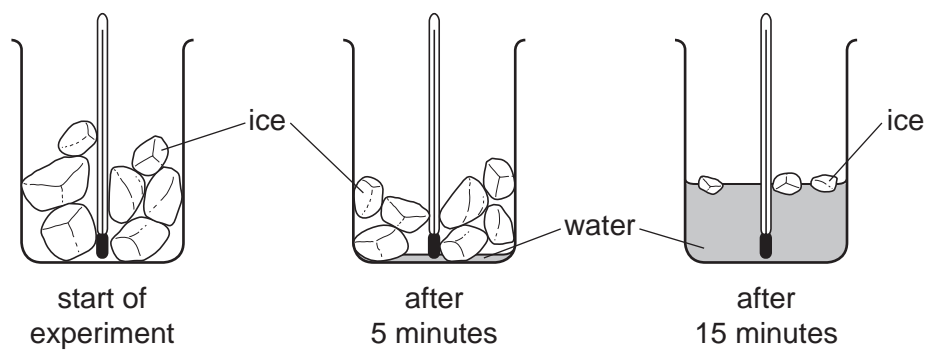

Which graph shows how the thermometer reading changes?

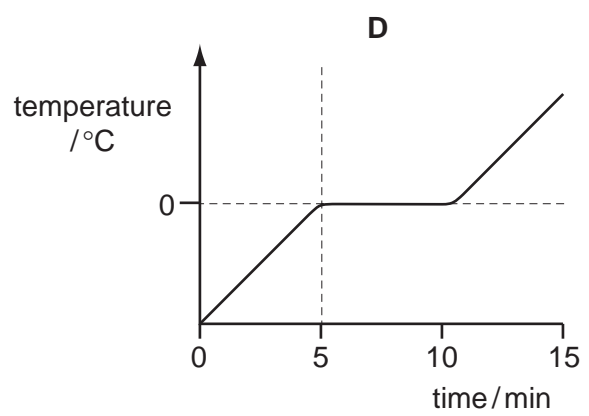
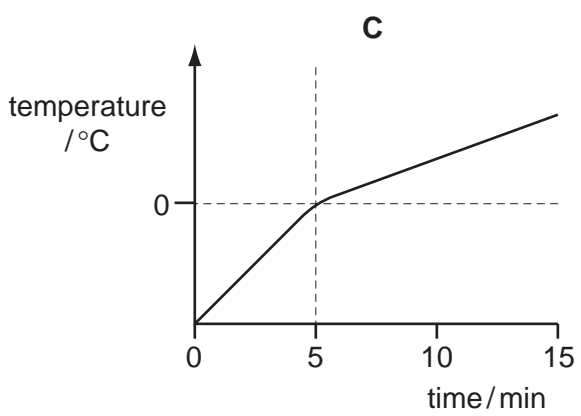
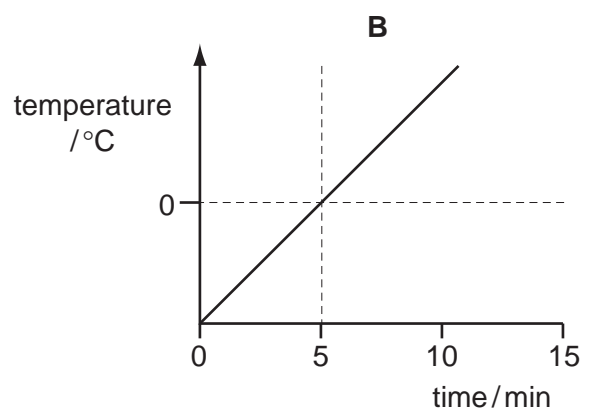
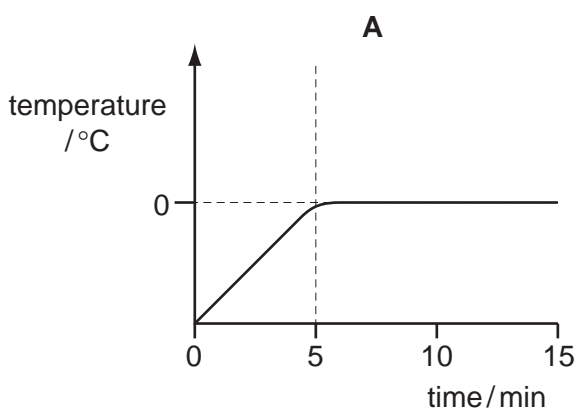

- 19 A piece of wood has some iron nails pushed through it. One side of the wood is covered with heat sensitive paper which turns from pink to blue when heated. The wood is heated as shown in the diagram for a few minutes and blue dots appear on the heat sensitive paper where it touches the nails.

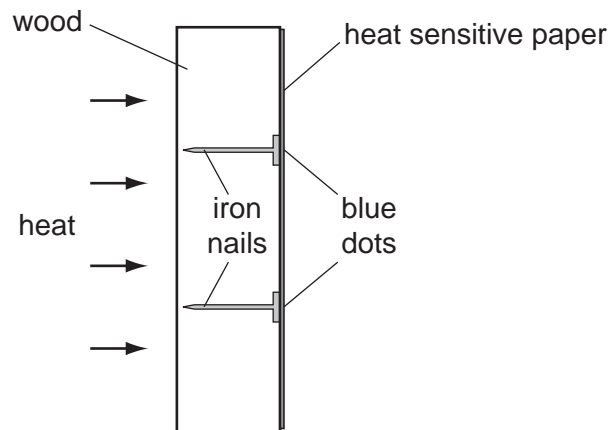

This experiment shows that, compared to wood, iron is a good

- A absorber of heat.
 - B conductor of heat.
 - C convector of heat.
 - D emitter of heat.
- 20 Which group contains only transverse waves?
- A infra-red waves, light waves, sound waves
 - B infra-red waves, light waves, ultra-violet waves
 - C infra-red waves, ultra-violet waves, sound waves
 - D light waves, sound waves, ultra-violet waves

21 The diagrams represent two different sound waves.

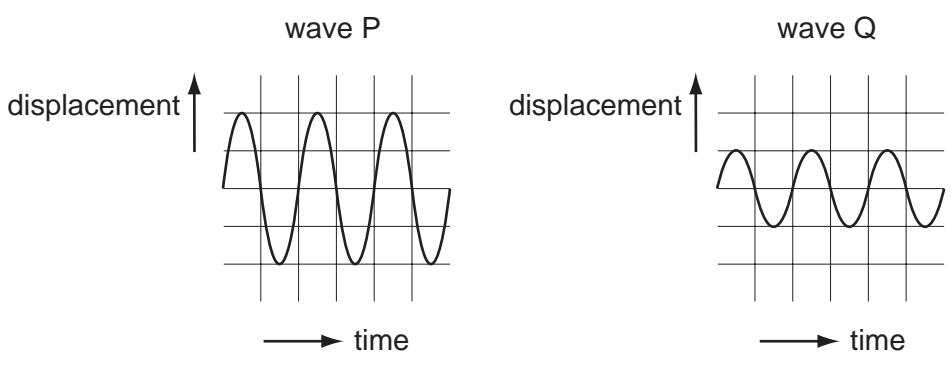

How do the frequency and pitch of P compare with the frequency and pitch of Q?

	frequency of P	pitch of P
A	greater than Q	higher than Q
B	greater than Q	same as Q
C	same as Q	higher than Q
D	same as Q	same as Q

22 A ship sends a pulse of sound vertically downwards to the sea bed. An echo is heard 0.4 seconds later.

If the speed of sound in the water is 1200 m/s, how deep is the water below the ship?

- A** 240 m **B** 480 m **C** 1500 m **D** 3000 m

23 A girl writes the word **LEFT** on a piece of card.



She looks at the image of this card, made by reflection by a plane mirror.

What does she see?

- A** **B** **C** **D**

- 24 Water waves in a tank pass over a thin plastic block as shown.

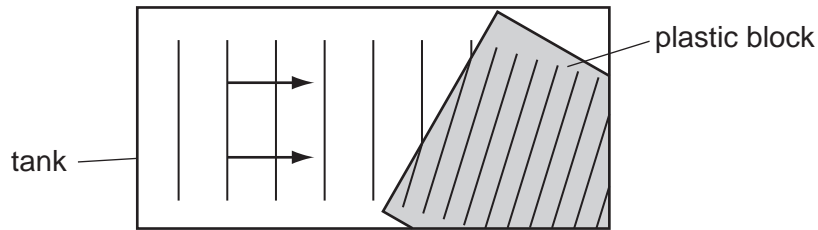

What happens to the waves as they reach the plastic block?

- A They are diffracted because they slow down.
 B They are diffracted because they speed up.
 C They are refracted because they slow down.
 D They are refracted because they speed up.
- 25 A scientist is trying to direct a ray of light through a glass block without any light leaving the top of the block. However, some light does leave the top.

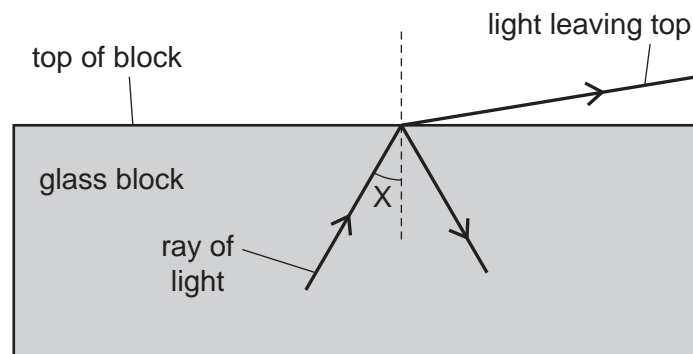

The scientist changes angle X and stops the ray of light leaving the top.

Which row in the table describes the change to angle X and the name of the effect produced?

	change to angle X	name of effect produced
A	decrease	total internal reflection
B	decrease	total internal refraction
C	increase	total internal reflection
D	increase	total internal refraction

- 26 Which statement about a magnet is **not** correct?

- A It can attract another magnet.
 B It can attract an unmagnetised piece of iron.
 C It can repel another magnet.
 D It can repel an unmagnetised piece of iron.

- 27 A chain of steel nails and a chain of iron nails hang from a strong magnet. The chains are carefully removed from the magnet.

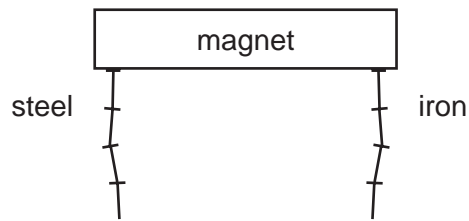

What happens to the chains?

- A Both chains fall apart.
 - B Both chains stay together.
 - C Only the chain of iron nails falls apart.
 - D Only the chain of steel nails falls apart.
- 28 The diagram shows a circuit containing two ammeters and three resistors.

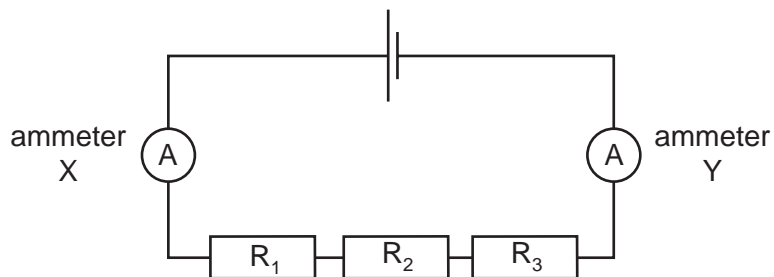

Which of the ammeters will show the current in resistor R_2 ?

- A ammeter X only
- B ammeter Y only
- C both ammeter X and ammeter Y
- D neither ammeter X nor ammeter Y

- 29 A circuit contains two resistors connected in parallel with a battery.

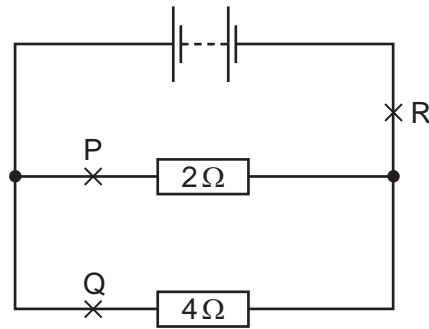

Which of the following statements about the currents at P, Q and R is true?

- A** The current at P is the greatest.
B The current at Q is the greatest.
C The current at R is the greatest.
D The current is the same at points P, Q and R.
- 30 A potential difference (p.d.) across a resistor causes a current in it.

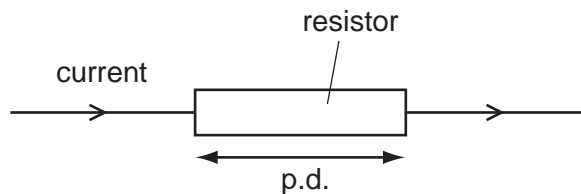

The p.d. and the resistance of the resistor can both be changed.

Which row shows two changes that will **both** increase the current in the resistor?

	change	change
A	decrease p.d.	decrease resistance
B	decrease p.d.	increase resistance
C	increase p.d.	decrease resistance
D	increase p.d.	increase resistance

14

31 The potential divider shown is connected across a constant 12V supply.

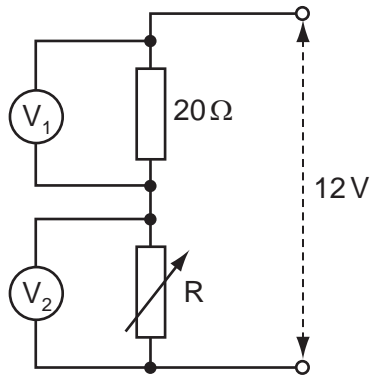

When R has a value of $20\ \Omega$, the voltmeter readings are equal.

How do these readings change when the value of R is reduced to $10\ \Omega$?

	reading on V_1	reading on V_2
A	decreases	decreases
B	decreases	increases
C	increases	decreases
D	increases	increases

32 Which component can store energy and can be used in time-delay circuits?

- A** a capacitor
- B** a potentiometer
- C** a resistor
- D** a thermistor

33 A coil is rotated steadily between the poles of a magnet. The coil is connected to an

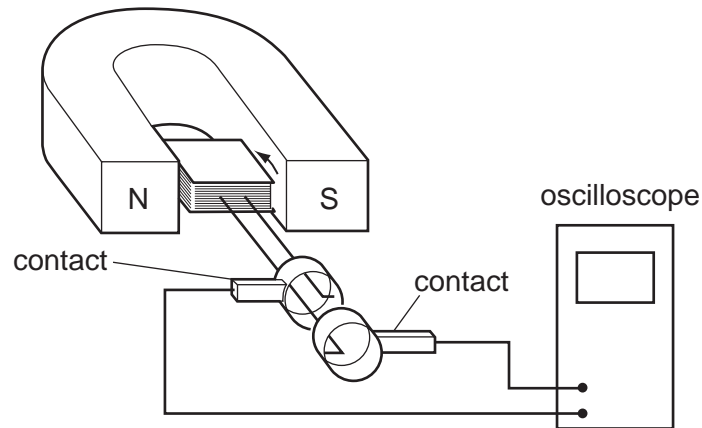

Which graph shows the output voltage V against time t ?

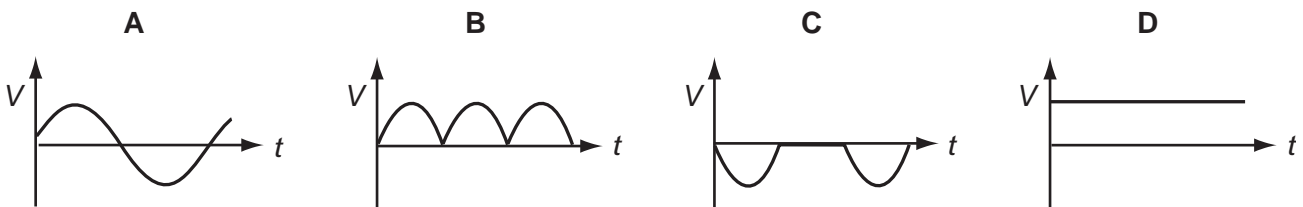

34 A fuse is a safety device for use in an electrical appliance.

How does a fuse affect a circuit when the current in it becomes higher than the correct value for the appliance?

- A It completely stops the current.
- B It reduces the current to the correct value for the appliance.
- C It sends the current to the outer case of the appliance.
- D It sends the excess current to the earth wire.

- 35 Some electrical equipment is connected to a 230 V supply. It is kept inside a metal case which is not earthed. The case is fixed to a plastic support. A strand of wire has become loose and touches the metal case as shown.

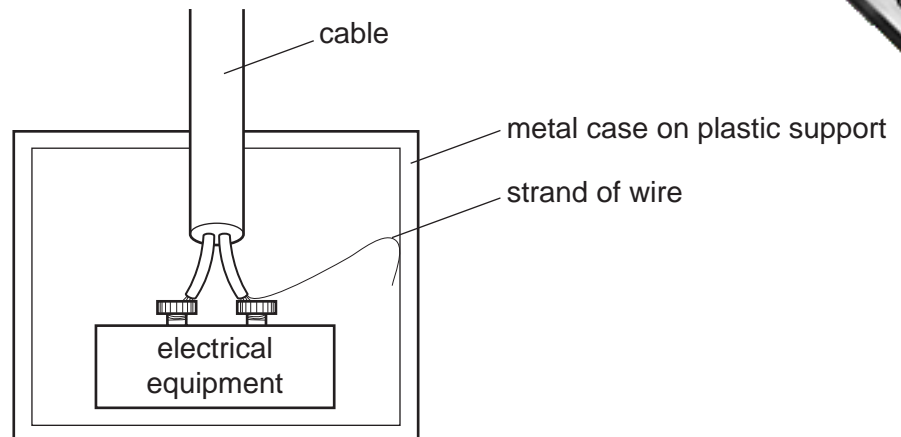

Which statement about this situation is correct?

- A** An electric current is passing through the metal case.
B A fuse in the live wire will blow.
C Someone touching the case would receive an electric shock.
D The metal case is at 0V.
- 36 A village has to be supplied with electricity from a power station that is a long way from the village.

Which type of current should be used, and at which voltage?

	type of current	voltage
A	alternating current	high voltage
B	alternating current	low voltage
C	direct current	high voltage
D	direct current	low voltage

37 An electric field is set up between two parallel plates.

Cathode rays are directed into this field, parallel to the plates.

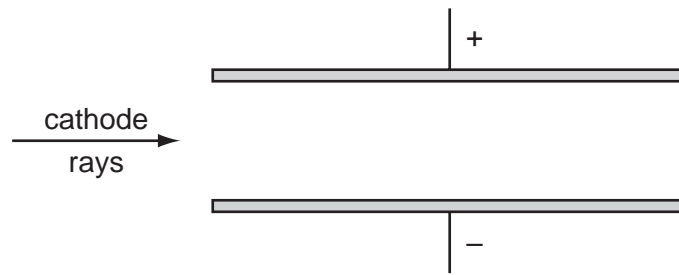

In which direction are the cathode rays deflected by the electric field?

- A downwards
 - B upwards
 - C into the page
 - D out of the page
- 38 S is a radioactive source emitting α -particles, β -particles and γ -rays. A detector is placed 5 cm away from S. A thin sheet of paper is placed as shown in the diagram.

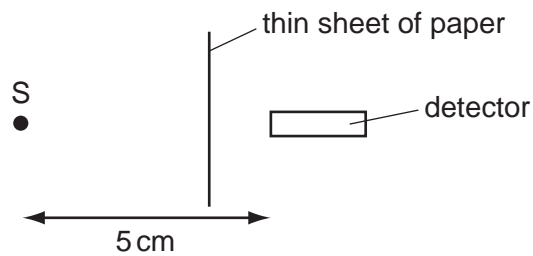

Which radiations can be detected?

- A α -particles and β -particles only
- B α -particles and γ -rays only
- C β -particles and γ -rays only
- D α -particles, β -particles and γ -rays

- 39 A radioactive element has a half-life of 70 s.

The number of emissions per second, N , of a sample of the element is measured at a time.

What was the number of emissions per second 70 s earlier?

- A 0 B $N/2$ C N D $2N$

- 40 In the atomic model, an atom consists of a central mass, orbited by much smaller particles.

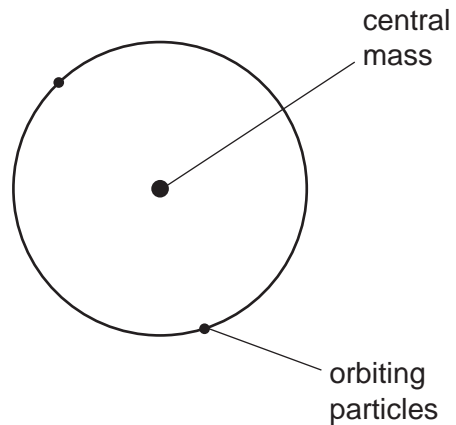

What is the name of the central mass and of the orbiting particles?

	central mass	orbiting particles
A	neutron	α -particles
B	neutron	electrons
C	nucleus	α -particles
D	nucleus	electrons

