



UNIVERSITY OF CAMBRIDGE INTERNATIONAL EXAMINATIONS
International General Certificate of Secondary Education

CANDIDATE
NAME

CENTRE
NUMBER

--	--	--	--	--

CANDIDATE
NUMBER

--	--	--	--



PHYSICS

0625/62

Paper 6 Alternative to Practical

October/November 2011

1 hour

Candidates answer on the Question Paper.
No Additional Materials are required.

READ THESE INSTRUCTIONS FIRST

Write your Centre number, candidate number and name on all the work you hand in.
Write in dark blue or black pen.
You may use a pencil for any diagrams, graphs or rough working.
Do not use staples, paper clips, highlighters, glue or correction fluid.
DO NOT WRITE IN ANY BARCODES.

Answer **all** questions.

At the end of the examination, fasten all your work securely together.
The number of marks is given in brackets [] at the end of each question or part question.

This document consists of **11** printed pages and **1** blank page.



1 The IGCSE class is investigating the law of moments.

Fig. 1.1 shows the apparatus used.

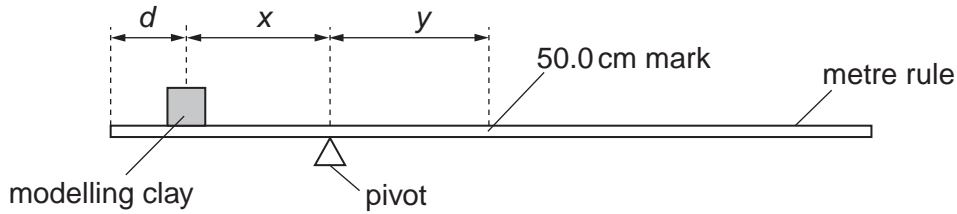

Fig. 1.1

(a) A student moulds a piece of modelling clay into a cube shape. He places the modelling clay on the rule so that its centre is a distance $d = 10.0$ cm from the zero end of the rule, as shown in Fig.1.1.

He adjusts the position of the rule so that it is as near as possible to being balanced, with the 50.0 cm mark to the right of the pivot.

(i) On Fig.1.1, measure the distance x from the centre of the modelling clay to the pivot.

$x =$

(ii) On Fig.1.1, measure the distance y from the pivot to the 50.0 cm mark on the rule.

$y =$ [1]

(b) The diagram is drawn one tenth of actual size.

(i) Calculate the actual distance X from the centre of the modelling clay to the pivot.

$X =$

(ii) Calculate the actual distance Y from the pivot to the 50.0 cm mark on the rule.

$Y =$

(iii) Calculate the mass m_1 of the piece of modelling clay using the equation

$$m_1 = \frac{MY}{X}$$

where the mass of the metre rule $M = 112$ g.

$m_1 =$

- (c) The student cuts the piece of modelling clay into two pieces, with one piece approximately twice the size of the other piece.

Using the larger piece of modelling clay, he repeats the procedure and obtains a result for mass m_2 of 64.9 g.

Using the smaller piece of modelling clay, he repeats the procedure and obtains a result for the mass m_3 of 34.5 g.

Calculate $(m_2 + m_3)$.

$(m_2 + m_3) = \dots\dots\dots$ [1]

- (d) Assuming that the experiment has been carried out with care, suggest two reasons why $(m_2 + m_3)$ may not be equal to m_1 .

1.

2.
 [2]

- (e) Explain briefly how you would ensure that the centre of the cube of modelling clay is at the 10.0 cm mark on the metre rule. You may draw a diagram.

.....

 [1]

[Total: 9]

2 An IGCSE student is investigating temperature changes when hot water and cold water are mixed. She is provided with a supply of hot water and a supply of cold water.

(a) The temperature θ_c of the cold water is 24°C .

She pours 100cm^3 of the hot water into a beaker. Record the temperature θ_h of this water, as shown on the thermometer.

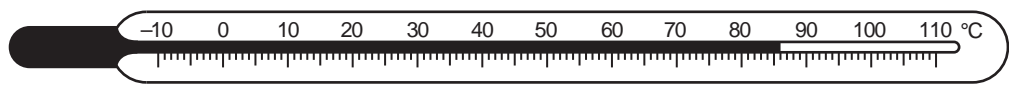

Fig. 2.1

$\theta_h = \dots\dots\dots [1]$

(b) She adds 10cm^3 of the cold water to the beaker of hot water. She briefly stirs the mixture of hot and cold water and records in Table 2.1 the temperature θ_m of the mixture of hot and cold water. She quickly repeats this five times, adding 10cm^3 of cold water each time, until a total of 60cm^3 has been added. She records the temperature θ_m of the mixture of hot and cold water at each stage.

Table 2.1

$V/$	$\theta_m/$
	78
	74
	68
	63
	61
	59

(i) Complete the volume column in the table, where V is the total volume of cold water so far added.

(ii) Complete the column headings in the table. [2]

(c) Plot the graph of temperature θ (y-axis) against volume V (x-axis).

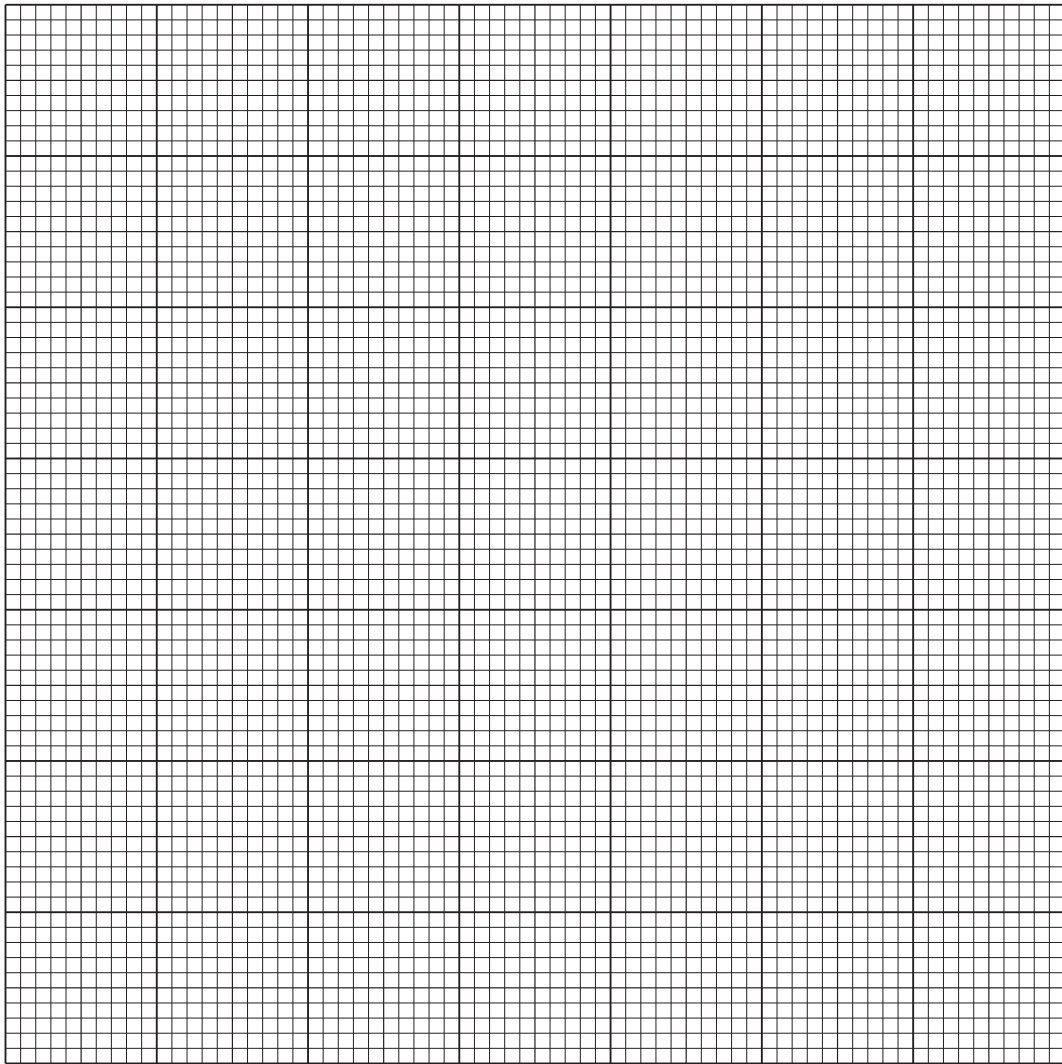

[4]

(d) If this experiment were to be repeated in order to check the results, it would be important to control the conditions. Suggest two such conditions that should be controlled.

1.

2.[2]

(e) Suggest a practical precaution that will enable readings in this experiment to be taken as accurately as possible.

.....

.....[1]

[Total: 10]

3 The IGCSE class is investigating the potential difference across resistors in a circuit.

Fig. 3.1 shows the circuit.

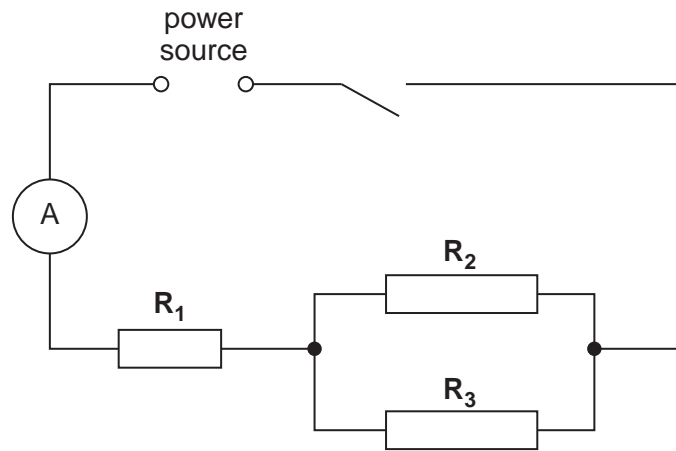

Fig. 3.1

(a) A student measures the potential difference V_A across resistor R_1 .

Write down the reading of V_A shown in Fig. 3.2.

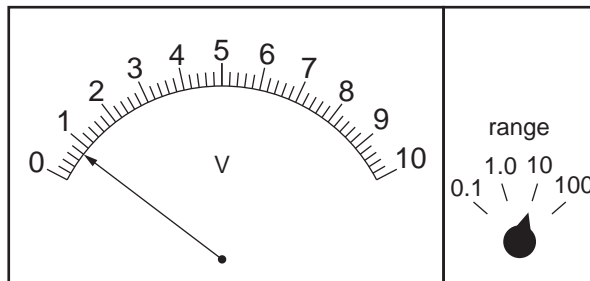

Fig. 3.2

V_A [1]

(b) He then measures the potential difference V_B across resistors R_2 and R_3 and the potential difference V_C across the combination of the three resistors.

The values are: $V_B = 1.4V$ and $V_C = 2.1V$.

Theory suggests that $V_C = (V_A + V_B)$.

(i) Calculate $(V_A + V_B)$.

$(V_A + V_B) =$

- (ii) State whether the experimental results support the theory. Justify your statement with reference to the results.

statement

justification

.....

.....

[3]

- (c) The current I indicated by the ammeter is 0.27A. Calculate the resistance R of the combination of the three resistors using the equation $R = \frac{V_C}{I}$.

$R =$ [1]

- (d) On Fig. 3.1, draw in the voltmeter connected to measure the potential difference V_B across resistors R_2 and R_3 . Use the standard symbol for a voltmeter. [1]

- (e) Refer to Fig. 3.2. Comment on the student's choice of the 10V range for the measurement of V_A .

.....

.....

.....[1]

[Total: 7]

4 An IGCSE student is investigating the reflection of light by a plane mirror.

Fig. 4.1 shows her ray trace sheet.

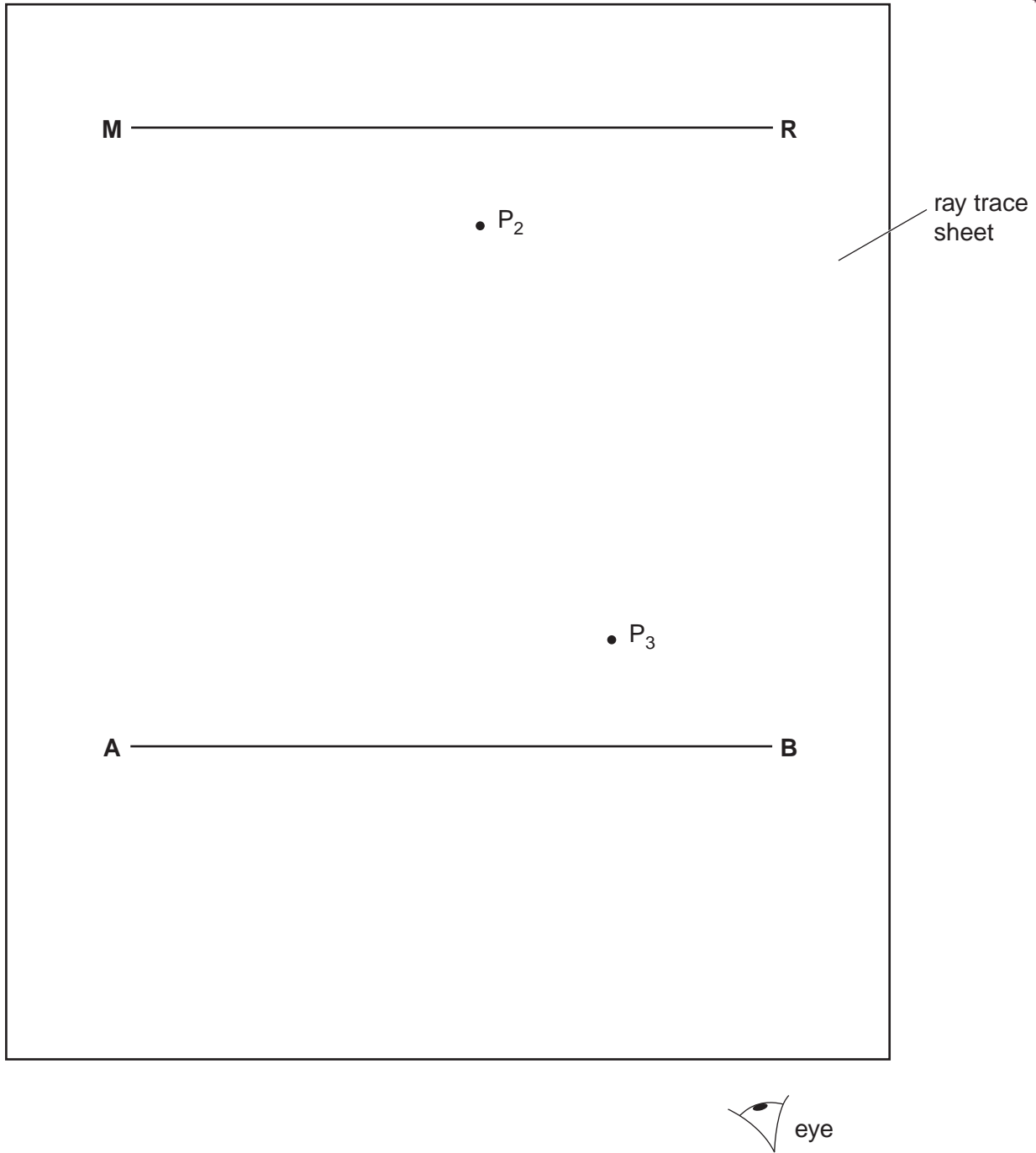

Fig. 4.1

- (a) The line **MR** shows the position of a mirror.
 - (i) Draw a normal to **MR** at its centre. Label the normal **NL** with **N** at the centre of **MR** and **L** on **AB**.
 - (ii) Mark a point on **AB**, 3.0 cm to the left of **L**. Label this point **C**.

[2]

- (b) Fig. 4.2 shows the mirror which is made of polished metal and has a vertical line. The lower end of this line is at point **N**.

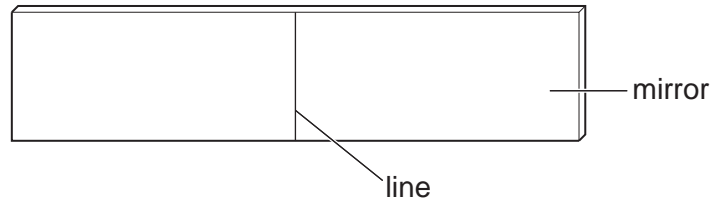

Fig. 4.2

In the experiment, the student places a pin P_1 at **C**. The student views the line on the mirror and the image of pin P_1 from the direction indicated by the eye in Fig. 4.1. She places two pins P_2 and P_3 some distance apart so that the image of P_1 , the line on the mirror, and pins P_2 and P_3 , all appear exactly one behind the other. The positions of P_2 and P_3 are shown.

- (i) Draw the line joining the positions of P_2 and P_3 . Continue the line until it meets the normal.
- (ii) Draw the line joining point **C** and point **N**. [1]
- (iii) Measure, and record in Table 4.1, the angle of incidence i between the normal **NL** and the line **CN**. Measure, and record in the table, the angle of reflection r between the normal and the line passing through P_2 and P_3 .
- (iv) Complete the column headings in the table.

Table 4.1

distance of P_1 from the normal/	$i/$	$r/$
3.0		
4.0	23	22
5.0	27	28

[2]

- (c) The student repeats the procedure using positions of P_1 that are 4.0cm and 5.0cm from the normal. The readings are shown in the table.

In spite of carrying out this experiment with reasonable care, it is possible that the values of the angle of reflection r will not be exactly the same as the values obtained from theory. Suggest two possible causes of this inaccuracy.

1.
 2.
- [2]

(d) Suggest one precaution that you would take in this experiment to ensure that the results are as accurate as possible.

.....
.....[1]

[Total: 8]

5 The IGCSE class is investigating springs.

A student measures the length l_0 of a spring and then uses a stand and clamp to suspend the spring vertically. He hangs a weight W on the spring and measures the new length l . He calculates the extension e of the spring. He repeats the procedure using a range of weights.

Table 5.1 shows some readings obtained by the student. The unstretched length l_0 of the spring is 16mm.

Table 5.1

W/N		
0	16	0
0.10	17	
0.20	19	
0.30	21	
0.40	23	
0.50	27	
0.60	33	

- (a) Complete the column headings in Table 5.1.
- (b) Complete the third column in the table by calculating the extension e of the spring.
- (c) State whether the results support the suggestion that the extension is directly proportional to the load. Justify your answer by reference to the results.

statement

justification

.....

.....[2]

- (d) Draw a diagram of the apparatus including the spring, clamp, a weight hanging on the spring and a ruler positioned to measure the length of the spring.

[2]

[Total: 6]

