



Cambridge International Examinations
Cambridge International General Certificate of Secondary Education

CANDIDATE
NAME

CENTRE
NUMBER

--	--	--	--	--

CANDIDATE
NUMBER

--	--	--	--



PHYSICS

0625/62

Paper 6 Alternative to Practical

May/June 2015

1 hour

Candidates answer on the Question Paper.

No Additional Materials are required.

READ THESE INSTRUCTIONS FIRST

Write your Centre number, candidate number and name on all the work you hand in.

Write in dark blue or black pen.

You may use an HB pencil for any diagrams or graphs.

Do not use staples, paper clips, glue or correction fluid.

DO NOT WRITE IN ANY BARCODES.

Answer **all** questions.

Electronic calculators may be used.

You may lose marks if you do not show your working or if you do not use appropriate units.

At the end of the examination, fasten all your work securely together.

The number of marks is given in brackets [] at the end of each question or part question.

The syllabus is approved for use in England, Wales and Northern Ireland as a Cambridge International Level 1/Level 2 Certificate.

This document consists of **12** printed pages.

1 The class is investigating a pendulum.

Figs. 1.1 and 1.2 show the pendulum.

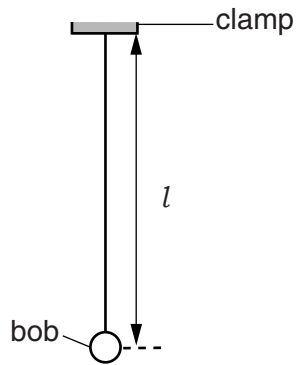

Fig. 1.1

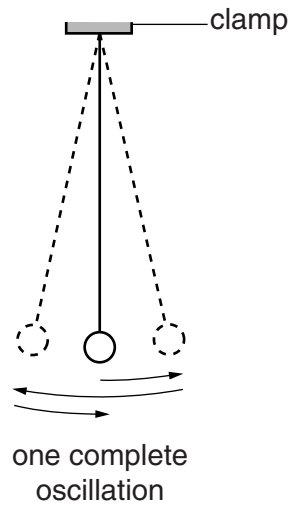

Fig. 1.2

(a) A student adjusts the pendulum until its length $l = 50.0$ cm.

State one precaution that you would take to measure the length l as accurately as possible. You may draw a diagram.

.....
[1]

- (b) The student displaces the pendulum bob slightly and releases it so that it swings. She measures the time t for 20 complete oscillations of the pendulum (see Fig. 1.2).

- (i) Record the time t , in s, shown on the stopwatch in Fig. 1.3.



Fig. 1.3

$t = \dots\dots\dots$ s [1]

- (ii) Calculate the period T of the pendulum. The period is the time for one complete oscillation.

$T = \dots\dots\dots$ [1]

- (iii) Explain why measuring the time for 20 oscillations, rather than 1 oscillation, gives a more accurate value for T .

.....
 [1]

- (c) The student adjusts the length of the pendulum until its length $l = 100.0$ cm. She repeats the procedure and obtains a value for the period T .

$T = \dots\dots\dots 2.06$ s.....

Another student suggests that doubling the length l of the pendulum should double the period T .

State whether the results support this suggestion. Justify your answer by reference to the results.

statement

justification

..... [2]

- (d) To continue the investigation of the relationship between the length l of the pendulum and the period T , it is necessary to use a range of values of length l .

List additional l values that you would plan to use in the laboratory.

..... [2]

2 The class is investigating the cooling of water.

- (a) A student pours 100cm^3 of hot water into a beaker. He places a thermometer in the water. Fig. 2.1 shows the thermometer.

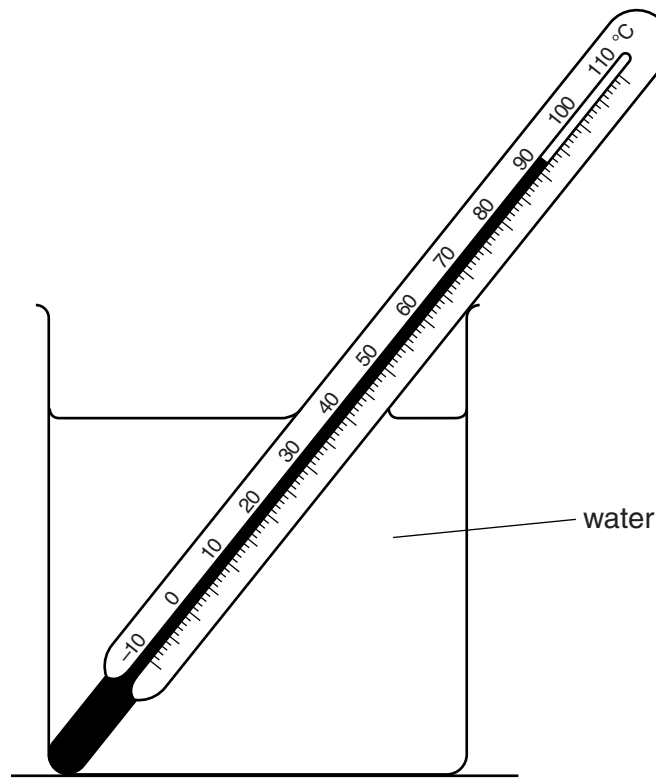

Fig. 2.1

- (i) Record the temperature θ_H of the hot water as shown on the thermometer in Fig. 2.1.

$$\theta_H = \dots\dots\dots [1]$$

- (ii) State one precaution that you would take to ensure that the temperature reading for the hot water is as reliable as possible.

.....
 [1]

- (b) The student adds 50cm^3 of cold water to the hot water. He records the temperature θ_1 .

$$\theta_1 = \dots\dots\dots 71^\circ\text{C} \dots\dots\dots$$

Calculate the decrease in temperature θ_A using the equation $\theta_A = (\theta_H - \theta_1)$.

$$\theta_A = \dots\dots\dots [1]$$

5

- (c) The student adds a further 100cm^3 of cold water to the water in the beaker. He records the temperature θ_2 .

$$\theta_2 = \dots\dots\dots 57^\circ\text{C} \dots\dots\dots$$

Calculate the decrease in temperature θ_B using the equation $\theta_B = (\theta_1 - \theta_2)$.

$$\theta_B = \dots\dots\dots [1]$$

- (d) Suggest two factors, other than the volume and temperature of the cold water added, that affect the decrease in temperature of the hot water.

1.

.....

2.

.....

[2]

- (e) Describe briefly how a measuring cylinder is read to obtain an accurate value for the volume of water. You may draw a diagram.

.....

.....

.....

..... [2]

[Total: 8]

- 3 The class is investigating the resistance of lamps.

Fig. 3.1 shows the first circuit used.

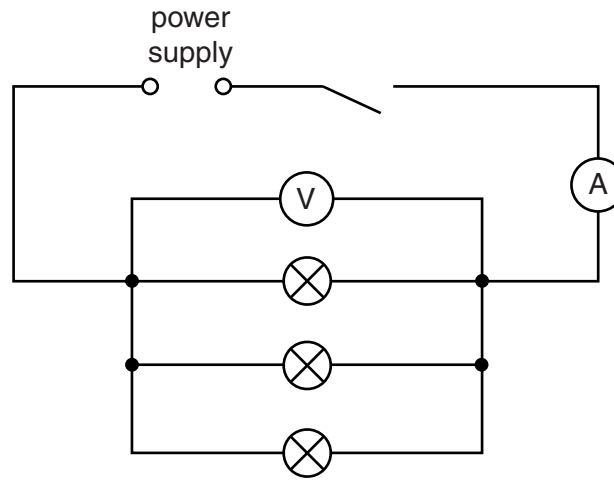

Fig. 3.1

- (a) A student measures the potential difference V_P across the lamps and the current I_P in the circuit. The readings are shown in Figs. 3.2 and 3.3.

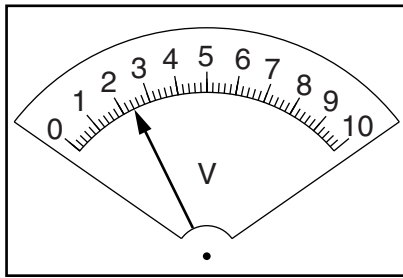

Fig. 3.2

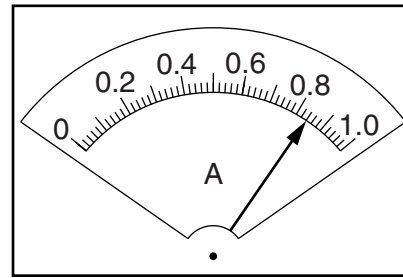

Fig. 3.3

- (i) Write down the readings shown on the meters.

$$V_P = \dots\dots\dots$$

$$I_P = \dots\dots\dots$$

[2]

- (ii) Calculate the resistance R_P of the lamp filaments using the equation $R_P = \frac{V_P}{I_P}$.

$$R_P = \dots\dots\dots [1]$$

- (b) The student rearranges the circuit so that
- the lamps are in series
 - the ammeter will measure the total current in the circuit
 - the voltmeter will measure the potential difference across all three lamps.

In the space below, draw a diagram of this circuit using standard circuit symbols.

[2]

- (c) The student measures the potential difference V_S across the lamps and the current I_S in the circuit in (b).

$$V_S = \dots\dots\dots 2.5V \dots\dots\dots$$

$$I_S = \dots\dots\dots 0.22A \dots\dots\dots$$

Calculate the resistance R_S of the lamp filaments using the equation $R_S = \frac{V_S}{I_S}$.

$$R_S = \dots\dots\dots [1]$$

- (d) (i) A student wishes to vary the current in the first circuit, shown in Fig. 3.1, using a variable resistor.

In the space below, draw the standard circuit symbol for a variable resistor.

[1]

- (ii) On Fig. 3.1, label with X a suitable position in the first circuit for a variable resistor used to vary the current in all the lamps. [1]

[Total: 8]

- 4 The class is investigating reflection using a plane mirror.

Fig. 4.1 shows a student's ray-trace sheet. The student uses an A4 sheet of plain paper.

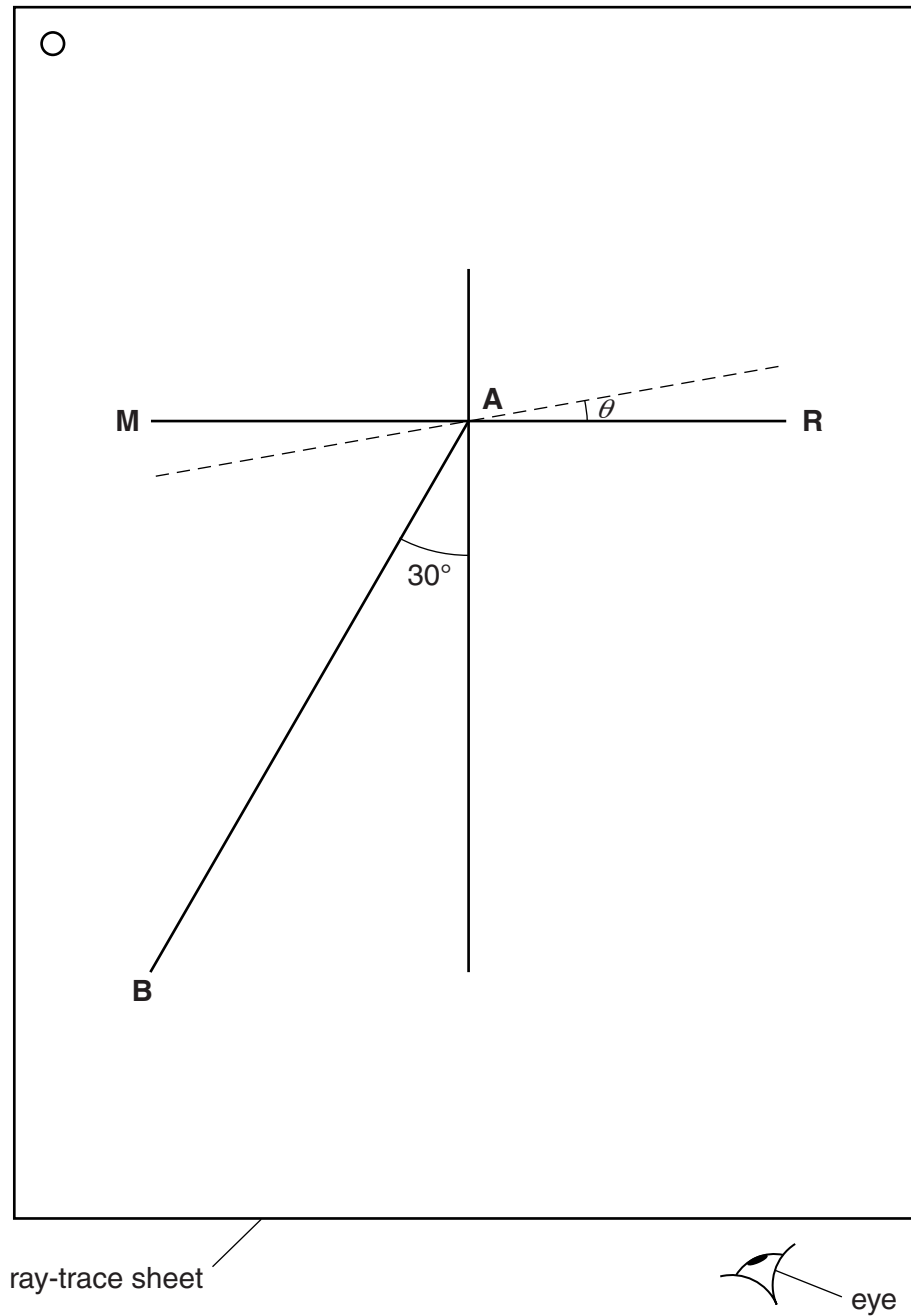

Fig. 4.1

- (a) On Fig. 4.1, the mirror is placed along the line **MR**. Label the normal **NL**. [1]
- (b) The student places two pins P_1 and P_2 on line **AB** at a suitable distance apart, so that she can accurately observe the reflection of line **AB**.

Suggest a suitable distance between the two pins.

distance =[1]

- (c) The student determines the angle between the reflected ray and the normal by viewing the images of pins P_1 and P_2 from the direction indicated by the eye in Fig. 4.1. She places two pins P_3 and P_4 , some distance apart, so that pins P_3 and P_4 , and the images of P_2 and P_1 , all appear exactly one behind the other. She draws a line joining the positions of P_3 and P_4 .

She measures the angle α between the normal and the line joining the positions of P_3 and P_4 . At this stage the angle θ between the mirror and line **MR** is 0° , as shown in Table 4.1.

She moves the mirror to a new position, shown by the dotted line on Fig. 4.1, at an angle $\theta = 10^\circ$ to **MR**. She repeats the procedure with pins P_3 and P_4 .

She continues using angles $\theta = 20^\circ$, 30° and 40° . The readings are shown in Table 4.1.

Table 4.1

$\theta/^\circ$	$\alpha/^\circ$
0	32
10	50
20	69
30	92
40	108

- (i) Plot a graph of $\alpha/^\circ$ (y -axis) against $\theta/^\circ$ (x -axis).

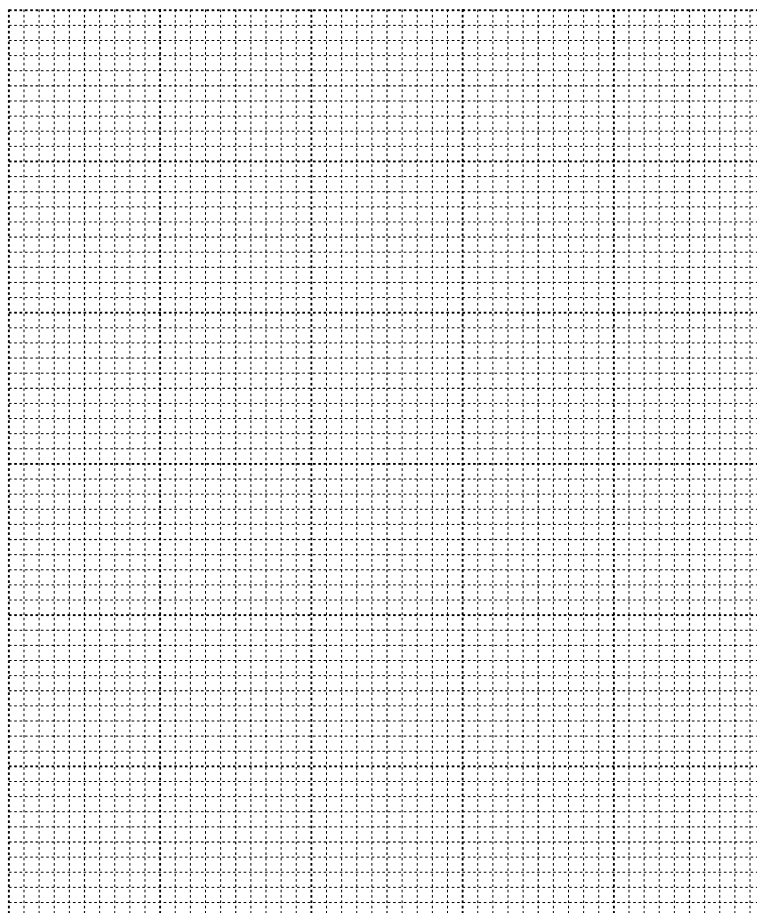

[5]

- (ii) State whether your graph line shows that the angle α is directly proportional to the angle θ . Justify your statement by reference to your graph line.

statement

justification

..... [2]

- (iii) Suggest why, when this experiment is carried out carefully, the points plotted may not all lie on the graph line.

.....
..... [1]

[Total: 10]

- 5 The class is investigating the image formed by a converging lens.

Fig. 5.1 shows the experimental set up.

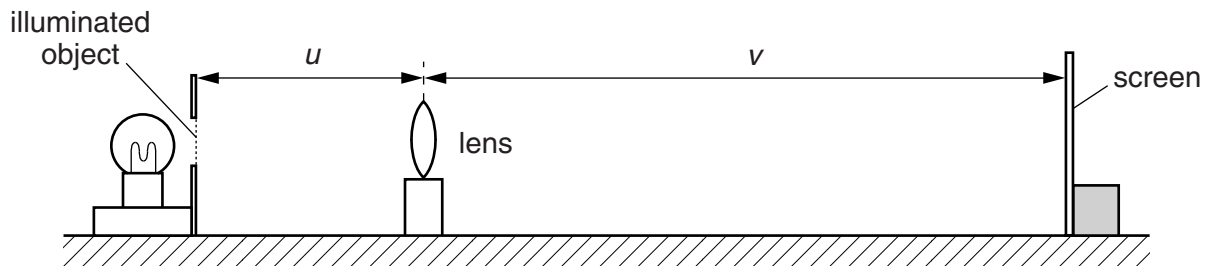

Fig. 5.1

A student positions the illuminated object and the lens and then moves the screen away from the lens until a sharply focused image of the object is formed on the screen.

The student measures the distances u and v , as shown in Fig. 5.1.

$$u = \dots\dots\dots 25.8 \text{ cm}$$

$$v = \dots\dots\dots 36.2 \text{ cm}$$

- (a) Calculate the focal length f of the lens using the equation $f = \frac{uv}{(u + v)}$. Give your answer to a suitable number of significant figures for this experiment.

$$f = \dots\dots\dots [2]$$

- (b) State two precautions you would take in the laboratory in order to obtain reliable measurements when doing this experiment.

1.

2.

[2]

Question 5 continues on the next page.

(c) The object in Fig. 5.1 is an illuminated triangle, as shown in Fig. 5.2.

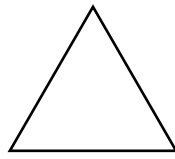

Fig. 5.2

Suggest two differences between the appearance of the illuminated object and the well-focused image on the screen.

1.

2.

[2]

[Total: 6]

Permission to reproduce items where third-party owned material protected by copyright is included has been sought and cleared where possible. Every reasonable effort has been made by the publisher (UCLES) to trace copyright holders, but if any items requiring clearance have unwittingly been included, the publisher will be pleased to make amends at the earliest possible opportunity.

To avoid the issue of disclosure of answer-related information to candidates, all copyright acknowledgements are reproduced online in the Cambridge International Examinations Copyright Acknowledgements Booklet. This is produced for each series of examinations and is freely available to download at www.cie.org.uk after the live examination series.

Cambridge International Examinations is part of the Cambridge Assessment Group. Cambridge Assessment is the brand name of University of Cambridge Local Examinations Syndicate (UCLES), which is itself a department of the University of Cambridge.