



**Cambridge International Examinations**  
Cambridge International General Certificate of Secondary Education

---

**COMBINED SCIENCE**

**0653/12**

Paper 1 Multiple Choice

**May/June 2014**

**45 minutes**

Additional Materials:      Multiple Choice Answer Sheet  
   Soft clean eraser  
   Soft pencil (type B or HB is recommended)

\* 7 9 1 4 8 7 3 5 1 2 \*

---

**READ THESE INSTRUCTIONS FIRST**

Write in soft pencil.

Do not use staples, paper clips, glue or correction fluid.

Write your name, Centre number and candidate number on the Answer Sheet in the spaces provided unless this has been done for you.

**DO NOT WRITE IN ANY BARCODES.**

There are **forty** questions on this paper. Answer **all** questions. For each question there are four possible answers **A, B, C** and **D**.

Choose the **one** you consider correct and record your choice in **soft pencil** on the separate Answer Sheet.

**Read the instructions on the Answer Sheet very carefully.**

Each correct answer will score one mark. A mark will not be deducted for a wrong answer.

Any rough working should be done in this booklet.

A copy of the Periodic Table is printed on page 20.

Electronic calculators may be used.

---

This document consists of **17** printed pages and **3** blank pages.

- 1 Which feature of a bird is the only one that helps to define it as a living organism?
- A It can fly.
  - B It has a hard, horny beak or bill.
  - C It is able to reproduce.
  - D The female lays eggs.
- 2 What causes oxygen to diffuse into the blood from an alveolus in the lungs?
- A The oxygen concentration in the alveolus is higher than in the atmosphere.
  - B The oxygen concentration in the alveolus is lower than in the blood.
  - C The oxygen concentration in the atmosphere is higher than the carbon dioxide concentration.
  - D The oxygen concentration in the blood is lower than in the alveolus.
- 3 What are enzymes made of?
- A carbohydrate
  - B fat
  - C fibre
  - D protein
- 4 The diagram shows part of the digestive system.

Where does egestion occur?

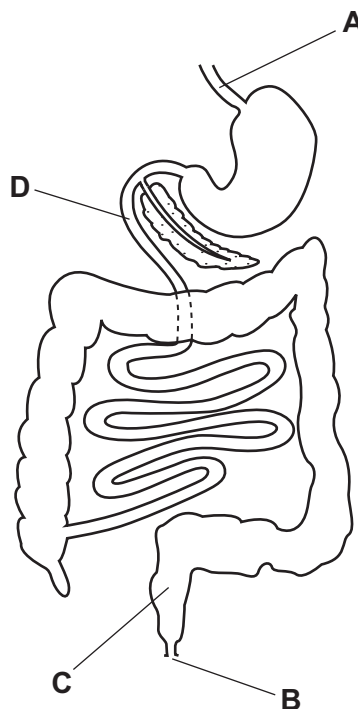

5 The diagram shows four human teeth.

Which tooth is a molar?

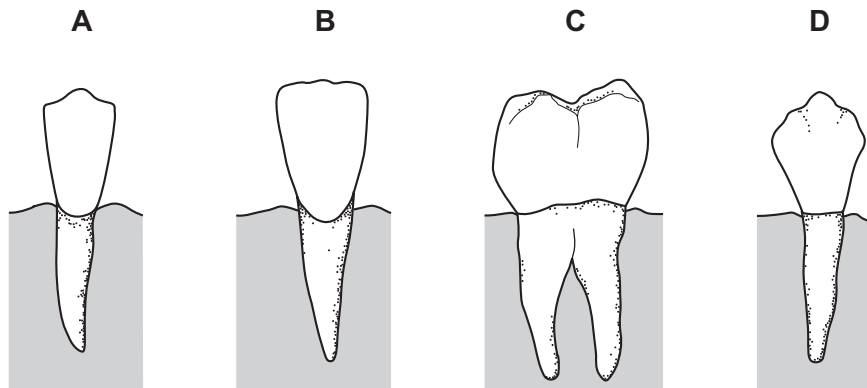

6 The diagram shows a section through the heart. The atria and ventricles are numbered.

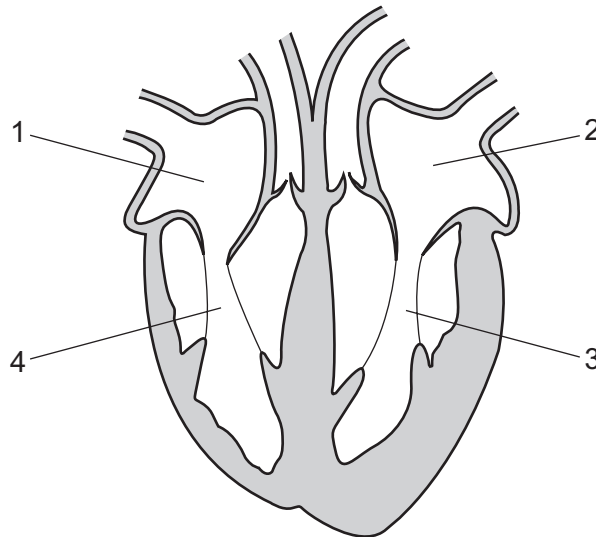

What is the sequence in which the atria and ventricles contract during one heart beat?

- A 1 and 2 together, 3 and 4 together
- B 1 and 4 together, 2 and 3 together
- C 1, 2, 3, 4
- D 1, 3, 2, 4

7 In which physical state is water when it is absorbed and when it is lost by a plant?

	absorbed	lost
<b>A</b>	liquid	liquid
<b>B</b>	liquid	vapour
<b>C</b>	vapour	liquid
<b>D</b>	vapour	vapour

8 Which row gives the correct information about aerobic respiration?

	nutrient molecules broken down	produces water	releases energy
<b>A</b>	✓	✓	✓
<b>B</b>	✓	✓	✗
<b>C</b>	✓	✗	✓
<b>D</b>	✗	✓	✓

key

✓ = information correct

✗ = information incorrect

9 Which statement is proved correct by breathing through the apparatus shown in the diagram?

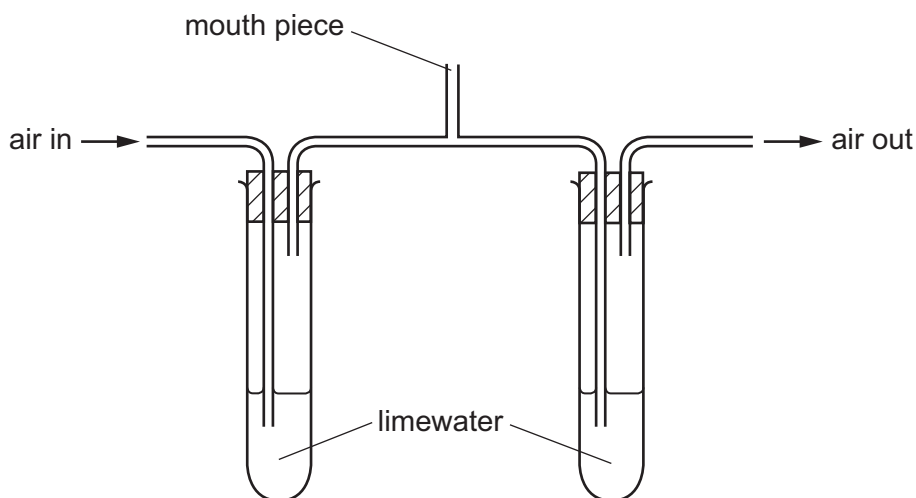

- A** Expired air contains less carbon dioxide than inspired air.
- B** Expired air contains more carbon dioxide than inspired air.
- C** Inspired air contains less oxygen than expired air.
- D** Inspired air contains more oxygen than expired air.

- 10 What happens after a hormone has had an effect on a target organ?
- A It is destroyed by the liver.
  - B It is reabsorbed by the gland that made it.
  - C It is stored for future use.
  - D It is used to increase the rate of heartbeat.
- 11 What would be effective in preventing the spread of HIV?
- A chlorinating all drinking water
  - B screening of blood before transfusions
  - C sterilisation of showers, baths and toilets
  - D thorough cooking of all food
- 12 The diagram shows a section through a flower.

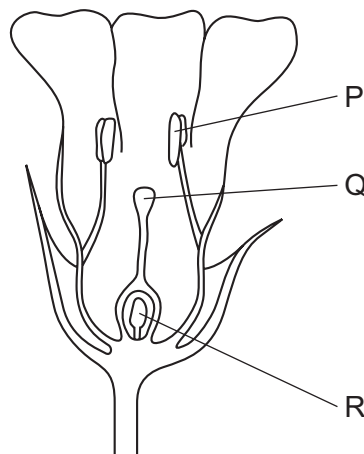

Where are the male and female gametes (sex cells) made?

	male gametes	female gametes
<b>A</b>	P	Q
<b>B</b>	P	R
<b>C</b>	Q	P
<b>D</b>	Q	R

13 The diagram shows a food web.

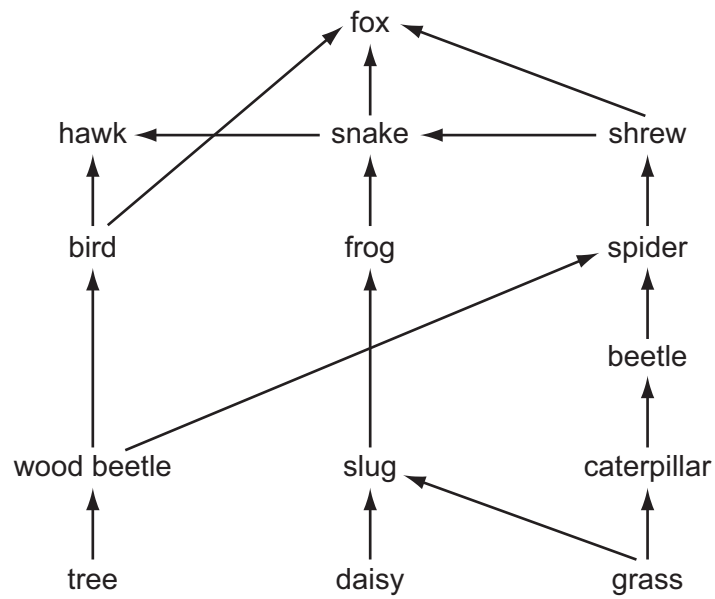

How many types of consumer and how many types of producer are shown in this food web?

	types of consumer	types of producer
<b>A</b>	3	3
<b>B</b>	3	14
<b>C</b>	11	3
<b>D</b>	11	14

14 A mixture contains two liquids.

One liquid has a boiling point of  $120^{\circ}\text{C}$  and the other boils at  $160^{\circ}\text{C}$ .

They are separated by fractional distillation.

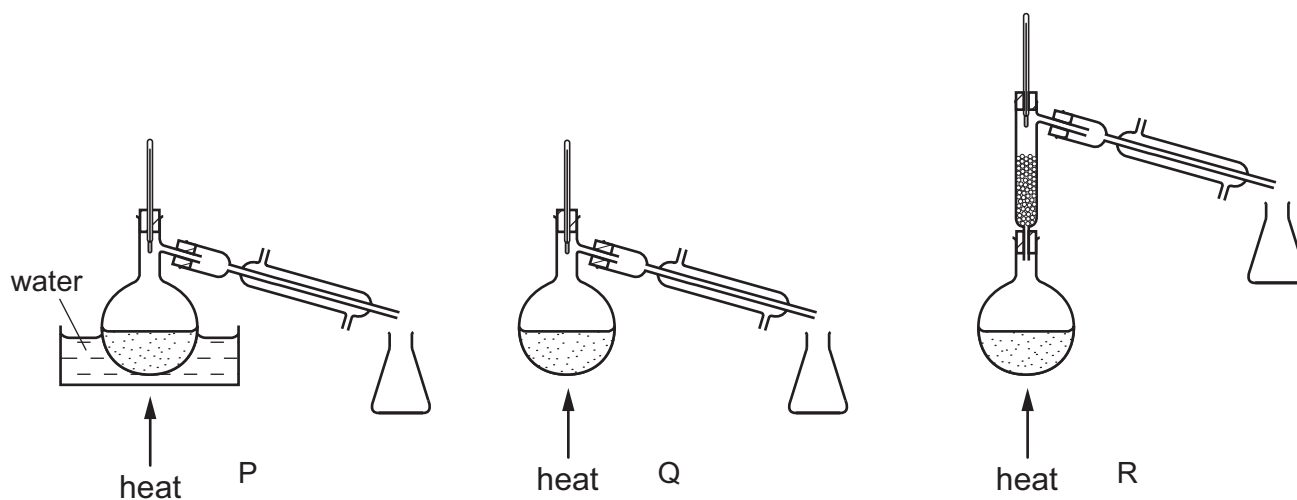

Which apparatus is used to separate the two liquids?

- A P and Q      B P only      C Q only      D R only

15 The diagram represents an atom.

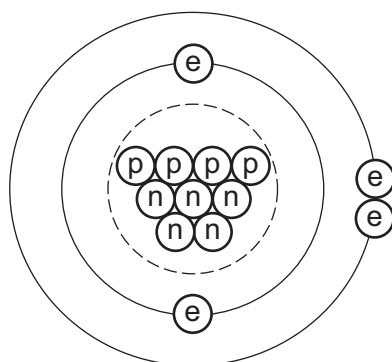

key

- (p) proton  
 (n) neutron  
 (e) electron  
 ○ nucleus

What is the nucleon number of this atom?

- A 2      B 4      C 9      D 13

16 The diagrams represent different substances.

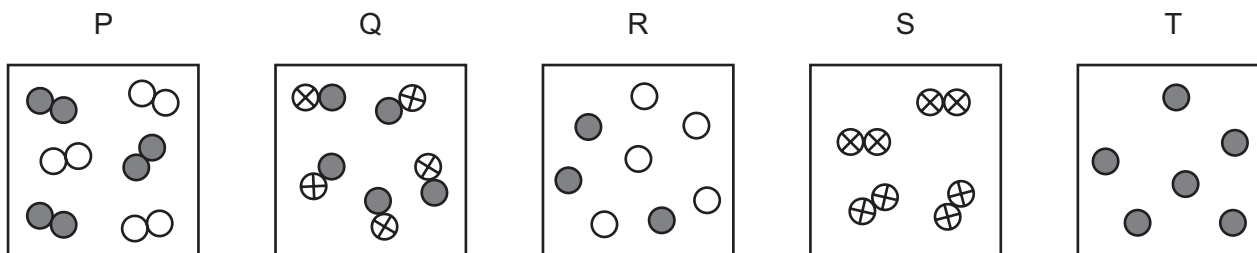

Which row correctly identifies the type of substance?

	an element	a compound	a mixture
<b>A</b>	P	R	Q
<b>B</b>	Q	S	P
<b>C</b>	S	Q	R
<b>D</b>	T	P	S

17 Sodium is in Group I of the Periodic Table.

What happens to an atom of sodium when it reacts?

- A** It gains one electron, forming  $\text{Na}^-$ .
- B** It gains one electron, forming  $\text{Na}^+$ .
- C** It loses one electron, forming  $\text{Na}^-$ .
- D** It loses one electron, forming  $\text{Na}^+$ .

18 A molecule of phosphoric acid contains three hydrogen atoms, one phosphorus atom and four oxygen atoms.

What is the formula of this molecule?

- A**  $\text{H}_3\text{PO}_4$
- B**  $\text{H}_3(\text{PO})_4$
- C**  $3\text{HPO}_4$
- D**  $3\text{HP}_4\text{O}$

19 The formula for iron(III) sulfate is  $\text{Fe}_2(\text{SO}_4)_3$ .

What is the total number of atoms in this formula?

- A** 3
- B** 7
- C** 17
- D** 26



20 Which products are formed when aqueous copper(II) chloride is electrolysed using inert electrodes?

	at the anode	at the cathode
<b>A</b>	chlorine	copper
<b>B</b>	chlorine	hydrogen
<b>C</b>	copper	chlorine
<b>D</b>	hydrogen	chlorine

21 The apparatus shown is used to test a property of compound R.

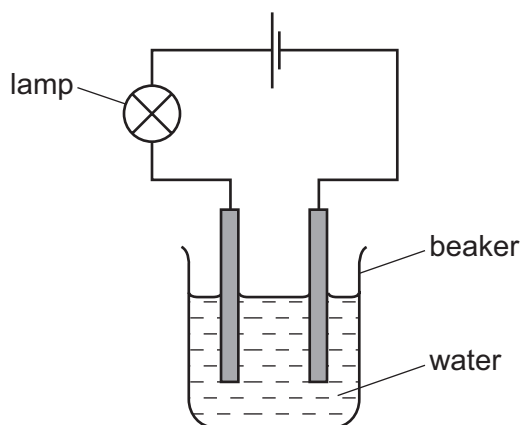

The lamp does not light when the beaker contains pure water.

When compound R is dissolved in the water, the lamp lights.

Which statements about R are correct?

	type of bonding	elements of compound R
<b>A</b>	covalent	a metal and a non-metal
<b>B</b>	covalent	non-metals only
<b>C</b>	ionic	non-metals only
<b>D</b>	ionic	a metal and a non-metal

22 Which change decreases the speed of a chemical reaction?

- A** increasing concentration
- B** increasing particle size
- C** increasing temperature
- D** using a catalyst

23 Which two reagents form a white precipitate when they are mixed?

- A barium chloride and hydrochloric acid
- B barium chloride and nitric acid
- C silver nitrate and hydrochloric acid
- D silver nitrate and nitric acid

24 A piece of metal is added to water.

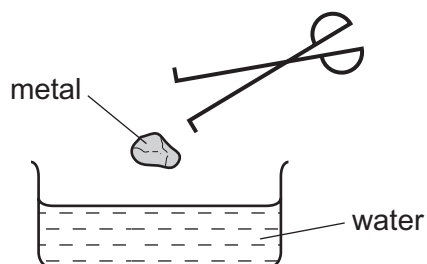

Which metal produces the most violent reaction?

- A copper
- B magnesium
- C potassium
- D zinc

25 Steel and sulfur are tested using the circuit shown.

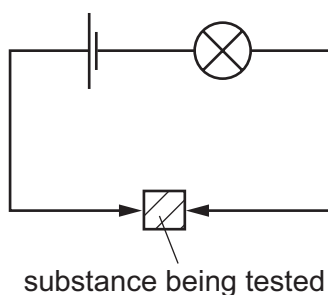

In which tests does the lamp light?

	steel	sulfur
<b>A</b>	✓	✓
<b>B</b>	✓	x
<b>C</b>	x	✓
<b>D</b>	x	x

key

✓ = lamp lights

x = lamp does not light

26 Which row gives the percentage by volume of the gases in the air?

	highest percentage	→	lowest percentage
<b>A</b>	nitrogen	oxygen	other gases
<b>B</b>	nitrogen	other gases	oxygen
<b>C</b>	oxygen	nitrogen	other gases
<b>D</b>	oxygen	other gases	nitrogen

27 Which statement describes a hydrocarbon?

- A** a compound that burns to form carbon dioxide and hydrogen
- B** a compound that contains carbon and hydrogen only
- C** a compound that only contains ionic bonds
- D** a compound that reacts easily with metals

28 The speed/time graph for a bus journey is shown.

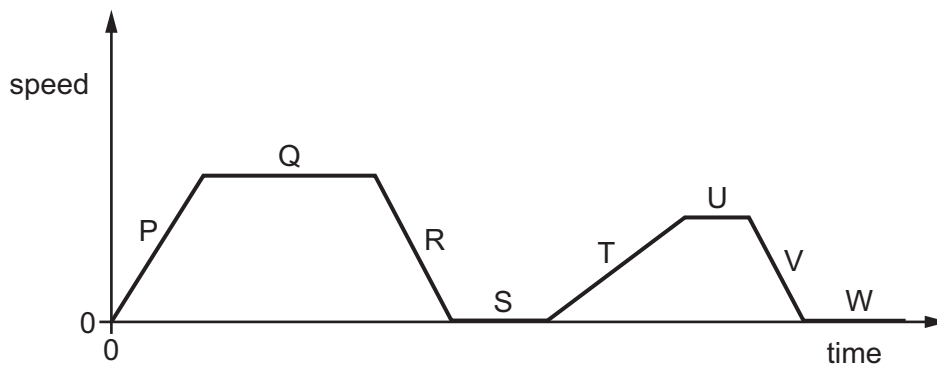

During which labelled periods was the bus stationary?

- A** P, R, T and V
- B** Q, S, U and W
- C** Q and U only
- D** S and W only

29 A glass tank contains some water.

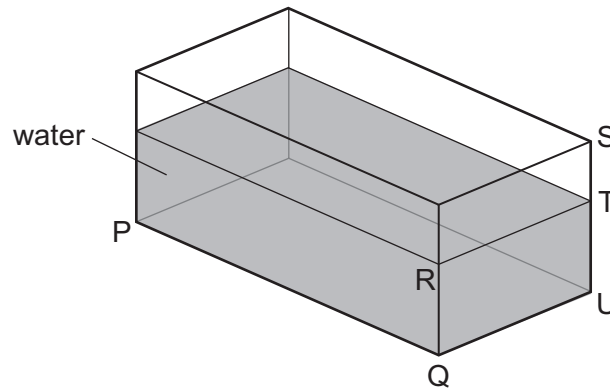

Only the length PQ and the width QU of the tank are known.

Which other distance must be known to calculate the volume of the water?

- A** RT                      **B** ST                      **C** SU                      **D** TU

30 A worker on a building site lifts a heavy concrete block onto a lorry. He then lifts a lighter block the same distance in the same time.

Which row about the work done and the power exerted is correct?

	work done in lifting the blocks	power exerted by worker
<b>A</b>	less for the lighter block	less for the lighter block
<b>B</b>	less for the lighter block	the same for both blocks
<b>C</b>	more for the lighter block	more for the lighter block
<b>D</b>	the same for both blocks	more for the lighter block

31 The diagram shows how the arrangement of the atoms in a substance changes during a change of state.

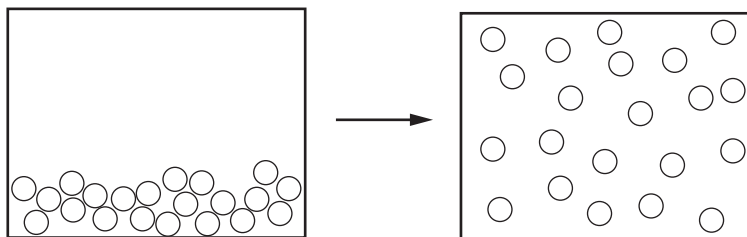

Which change of state is shown?

- A** gas to liquid  
**B** liquid to gas  
**C** liquid to solid  
**D** solid to liquid

32 A mechanic cannot remove a large steel nut from a steel bolt because it is too tight.

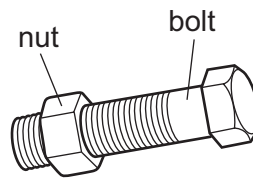

What could the mechanic do to help her remove the nut?

- A cool the nut and heat the bolt
  - B heat the bolt only
  - C heat the nut and the bolt through the same temperature rise
  - D heat the nut only
- 33 Diners sit at a table outside a café on a cold evening. A heater above the table warms the diners as they eat.

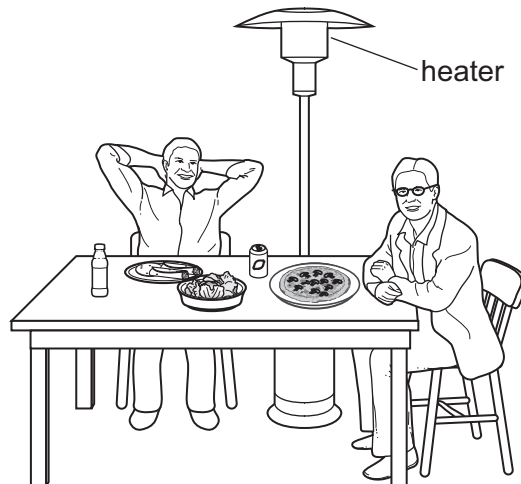

Which row shows how thermal (heat) energy from the heater reaches the diners?

	conduction	convection	radiation
<b>A</b>	no	no	yes
<b>B</b>	no	yes	yes
<b>C</b>	yes	no	yes
<b>D</b>	yes	yes	no

34 The diagram represents a wave.

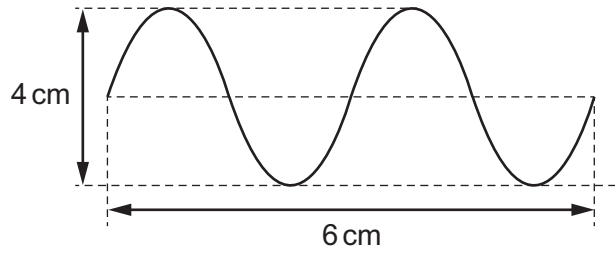

What is the amplitude of the wave?

- A** 2 cm      **B** 3 cm      **C** 4 cm      **D** 6 cm

35 Which diagram shows how a ray of light passes from air into a glass block, and shows the angle of incidence labelled  $i$ ?

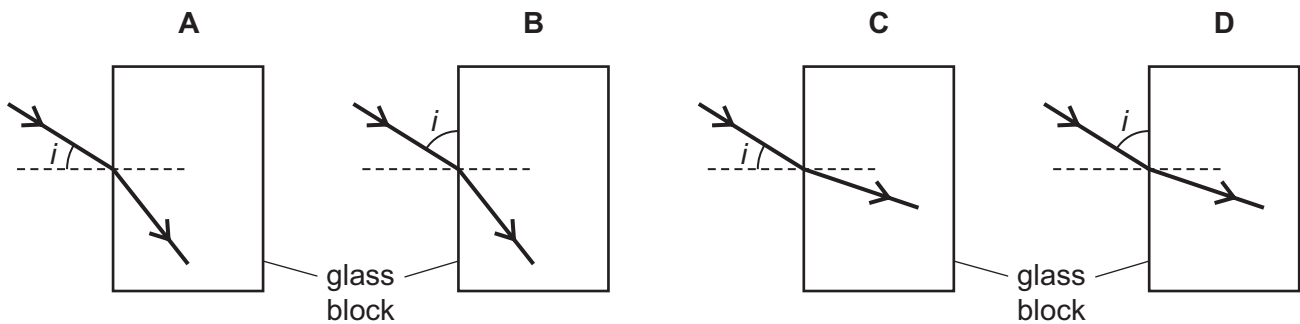

36 Which row shows the type of wave that is used for a mobile (cell) telephone and the type that is used to send television signals from a satellite to Earth?

	mobile telephone	satellite television
<b>A</b>	microwaves	microwaves
<b>B</b>	microwaves	radio waves
<b>C</b>	radio waves	microwaves
<b>D</b>	radio waves	radio waves

- 37 A boy on an island is 500 m from some cliffs.

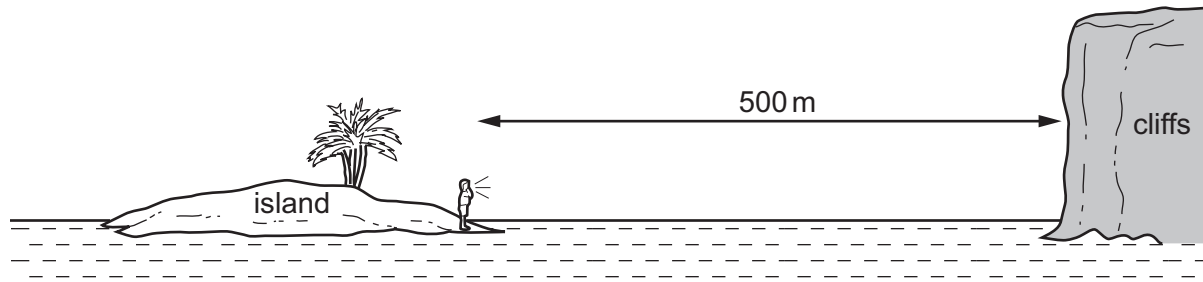

He shouts and he hears an echo from the cliffs.

Sound travels at 340 m/s through the air.

What is the time interval between when the boy shouts and when he hears the echo?

- A  $\frac{500}{340}$  s      B  $\frac{2 \times 500}{340}$  s      C  $\frac{340}{500}$  s      D  $\frac{2 \times 340}{500}$  s
- 38 An uncharged metal rod is held by an insulating handle.

The rod is brought near to a positively charged sphere. This causes some particles in the rod to move.

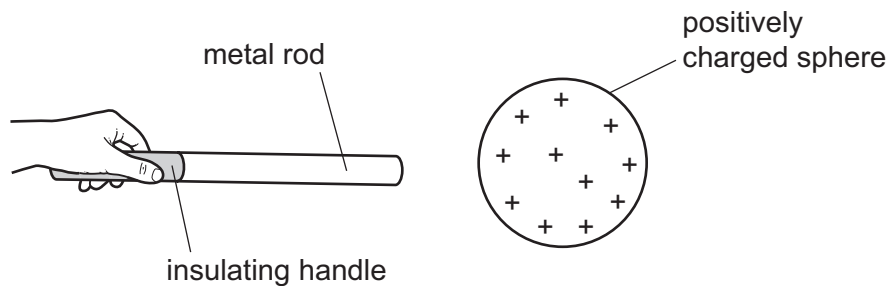

Which particles in the rod move and in which direction do the particles move?

	particles that move	direction of movement
<b>A</b>	electrons	away from the sphere
<b>B</b>	electrons	towards the sphere
<b>C</b>	neutrons	away from the sphere
<b>D</b>	protons	towards the sphere

39 A circuit diagram contains the following symbol.

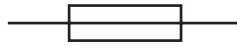

What does this symbol represent?

- A a fixed resistor
- B a fuse
- C a lamp
- D a variable resistor

40 In the circuit shown the switch is open.

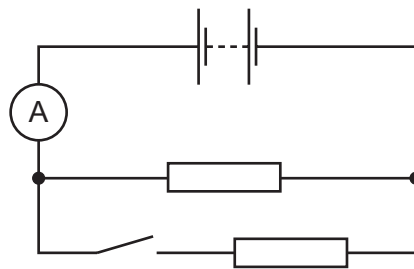

A student closes the switch.

What happens to the ammeter reading, and what happens to the total resistance of the circuit?

	ammeter reading	total resistance
<b>A</b>	decreases	decreases
<b>B</b>	decreases	increases
<b>C</b>	increases	decreases
<b>D</b>	increases	increases



**BLANK PAGE**

**BLANK PAGE**

**BLANK PAGE**

**DATA SHEET**  
**The Periodic Table of the Elements**

		Group															
	I	II	III	IV	V	VI	VII	0									
	1 <b>H</b> Hydrogen 1										2 <b>He</b> Helium 2						
3	7 <b>Li</b> Lithium 4	9 <b>Be</b> Beryllium 4										10 <b>Ne</b> Neon 10					
11	23 <b>Na</b> Sodium 11	24 <b>Mg</b> Magnesium 12										18 <b>Ar</b> Argon 18					
19	39 <b>K</b> Potassium 19	40 <b>Ca</b> Calcium 20	45 <b>Sc</b> Scandium 21	48 <b>Ti</b> Titanium 22	51 <b>V</b> Vanadium 23	52 <b>Cr</b> Chromium 24	55 <b>Mn</b> Manganese 25	56 <b>Fe</b> Iron 26	59 <b>Co</b> Cobalt 27	59 <b>Ni</b> Nickel 28	64 <b>Cu</b> Copper 29	65 <b>Zn</b> Zinc 30	73 <b>Ge</b> Germanium 32	75 <b>As</b> Arsenic 33	79 <b>Se</b> Selenium 34	80 <b>Br</b> Bromine 35	84 <b>Kr</b> Krypton 36
37	85 <b>Rb</b> Rubidium 37	88 <b>Sr</b> Strontium 38	89 <b>Y</b> Yttrium 39	91 <b>Zr</b> Zirconium 40	93 <b>Nb</b> Niobium 41	96 <b>Mo</b> Molybdenum 42	101 <b>Ru</b> Ruthenium 44	106 <b>Pd</b> Palladium 46	108 <b>Ag</b> Silver 47	112 <b>Cd</b> Cadmium 48	115 <b>In</b> Indium 49	122 <b>Sb</b> Antimony 51	128 <b>Te</b> Tellurium 52	131 <b>Xe</b> Xenon 54			
55	133 <b>Cs</b> Caesium 55	137 <b>Ba</b> Barium 56	139 <b>La</b> Lanthanum 57	178 <b>Hf</b> Hafnium 72	181 <b>Ta</b> Tantalum 73	184 <b>W</b> Tungsten 74	190 <b>Os</b> Osmium 76	195 <b>Pt</b> Platinum 78	197 <b>Au</b> Gold 79	201 <b>Hg</b> Mercury 80	204 <b>Tl</b> Thallium 81	209 <b>Pb</b> Lead 82	210 <b>Po</b> Polonium 84	210 <b>Rn</b> Radon 86			
87	226 <b>Fr</b> Francium 87	226 <b>Ra</b> Radium 88	227 <b>Ac</b> Actinium 89										86 <b>Rn</b> Radon 86				

	140 <b>Ce</b> Cerium 58	141 <b>Pr</b> Praseodymium 59	144 <b>Nd</b> Neodymium 60	150 <b>Sm</b> Samarium 62	152 <b>Eu</b> Europium 63	157 <b>Gd</b> Gadolinium 64	162 <b>Dy</b> Dysprosium 66	165 <b>Ho</b> Holmium 67	167 <b>Er</b> Erbium 68	169 <b>Tm</b> Thulium 69	173 <b>Yb</b> Ytterbium 70	175 <b>Lu</b> Lutetium 71		
	232 <b>Th</b> Thorium 90	232 <b>Pa</b> Protactinium 91	238 <b>U</b> Uranium 92	238 <b>Np</b> Neptunium 93	238 <b>Pu</b> Plutonium 94	238 <b>Am</b> Americium 95	238 <b>Cm</b> Curium 96	238 <b>Bk</b> Berkelium 97	238 <b>Cf</b> Californium 98	238 <b>Es</b> Einsteinium 99	238 <b>Fm</b> Fermium 100	238 <b>Md</b> Mendelevium 101	238 <b>No</b> Nobelium 102	238 <b>Lr</b> Lawrencium 103

	<b>a</b>	<b>X</b>	<b>b</b>
<b>Key</b>	a = relative atomic mass	X = atomic symbol	b = proton (atomic) number

\*58-71 Lanthanoid series  
†90-103 Actinoid series

The volume of one mole of any gas is 24 dm<sup>3</sup> at room temperature and pressure (r.t.p.).

Permission to reproduce items where third-party owned material protected by copyright is included has been sought and cleared where possible. Every reasonable effort has been made by the publisher (UCLES) to trace copyright holders, but if any items requiring clearance have unwittingly been included, the publisher will be pleased to make amends at the earliest possible opportunity.

Cambridge International Examinations is part of the Cambridge Assessment Group. Cambridge Assessment is the brand name of University of Cambridge Local Examinations Syndicate (UCLES), which is itself a department of the University of Cambridge.