



Cambridge International Examinations
Cambridge International General Certificate of Secondary Education

CANDIDATE
NAME

CENTRE
NUMBER

--	--	--	--	--

CANDIDATE
NUMBER

--	--	--	--

COMBINED SCIENCE

0653/61

Paper 6 Alternative to Practical

May/June 2016

1 hour

Candidates answer on the Question Paper.

No Additional Materials are required.

READ THESE INSTRUCTIONS FIRST

Write your Centre number, candidate number and name on all the work you hand in.

Write in dark blue or black pen.

You may use an HB pencil for any diagrams or graphs.

Do not use staples, paper clips, glue or correction fluid.

DO NOT WRITE IN ANY BARCODES.

Answer **all** questions.

Electronic calculators may be used.

You may lose marks if you do not show your working or if you do not use appropriate units.

At the end of the examination, fasten all your work securely together.

The number of marks is given in brackets [] at the end of each question or part question.

This document consists of **18** printed pages and **2** blank pages.

1 A student investigates the effectiveness of using an enzyme in the extraction of apple juice.

He has two beakers of apple pulp warmed to a temperature of 35 °C.

- He adds 2 cm³ of enzyme solution to beaker **A** and 2 cm³ of distilled water to beaker **B** and mixes the contents of each beaker.
- He returns the beakers to the water-bath and immediately starts a stopclock.
- After five minutes he empties the contents of both beakers into separate filter funnels as shown in Fig. 1.1.
- He records in Table 1.1 the volume of the juice collected in each measuring cylinder every 2 minutes for a total of 10 minutes.

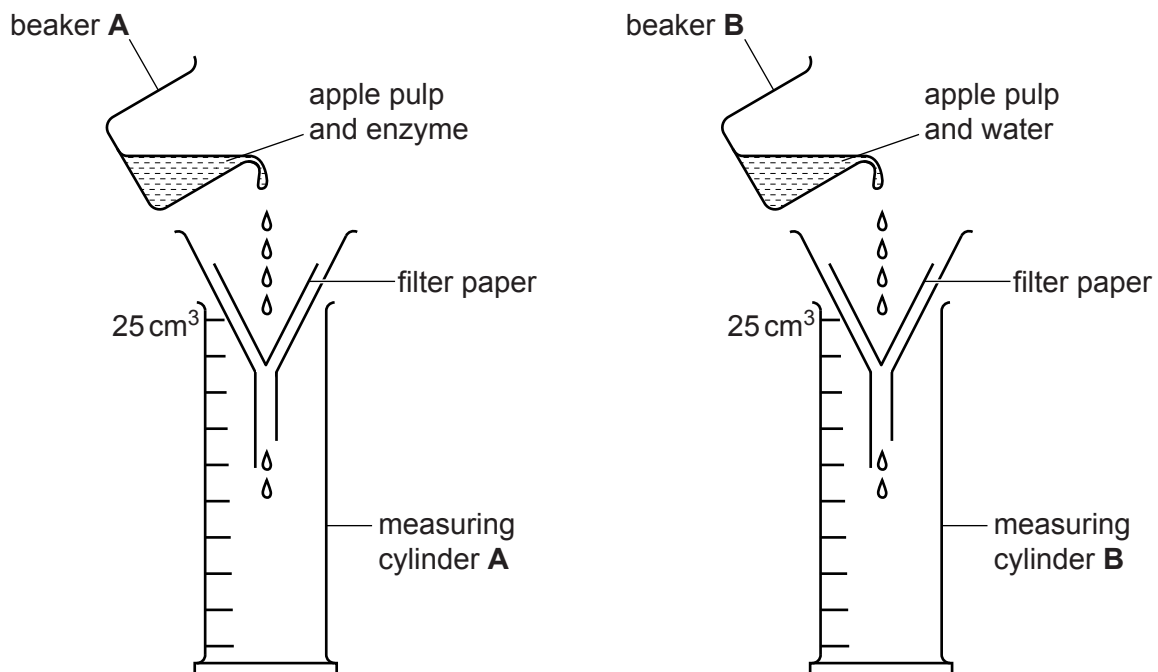

Fig. 1.1

(a) Insert headings, including units, in Table 1.1.

[2]

Table 1.1

..... / /	
	cylinder A	cylinder B
2	3.6	0.0
4	5.3	0.3
6		
8	7.5	0.5
10	8.1	0.5

- (b) Fig. 1.2 shows the volume of juice in measuring cylinders **A** and **B** after 6 minutes. Read these volumes and enter the values in Table 1.1. [2]

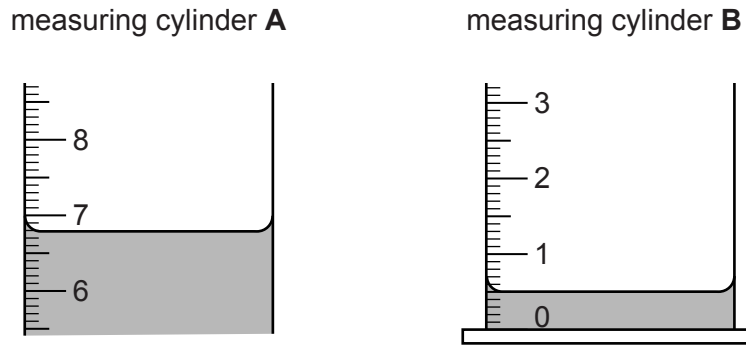
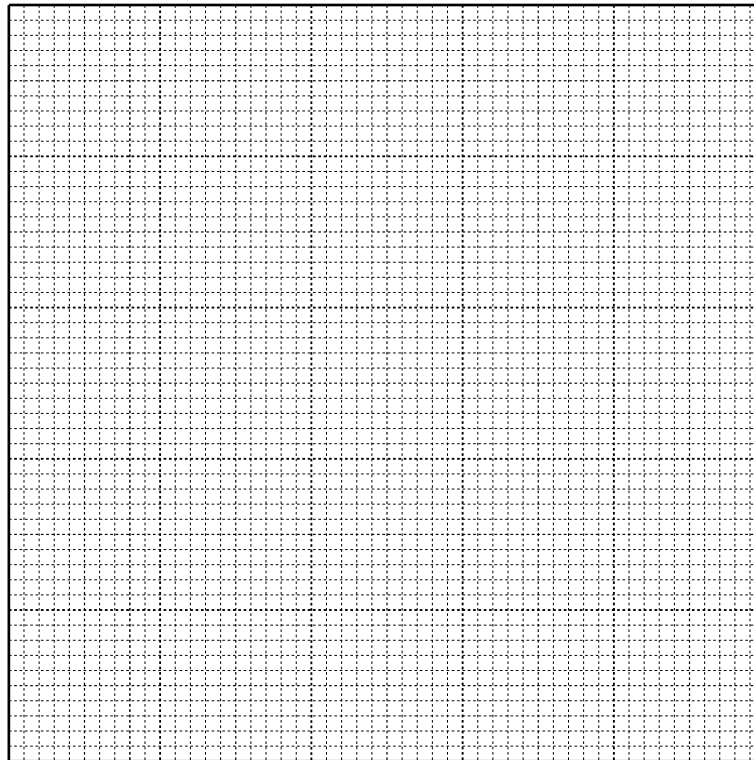

Fig. 1.2

- (c) On the grid provided, plot a graph of the results in measuring cylinder **A only** (vertical axis) against the values in column one of Table 1.1. Draw the best-fit line.



[4]

- (d) Enzymes are used for juice extraction in the fruit juice industry. Use the results to suggest an advantage to manufacturers in using an enzyme in the production of fruit juice.

.....[1]

- (e) Explain how beaker **B** acts as a control.

.....[1]

2 A student is given three solutions **C**, **D** and **E** of acid **X**.

He does not know the concentrations of the solutions.

(a) The student carries out an investigation to find out the concentration of each solution.

- Using a measuring cylinder he places 5 cm^3 of solution **C** in a test-tube.
- He adds a 1 cm piece of magnesium ribbon to this test-tube and starts the stopclock.
- When the magnesium ribbon has completely reacted and disappeared he stops the stopclock.
- If the magnesium ribbon is still present after 3 minutes, he records this time as $>180\text{ s}$.
- He repeats the above procedure for solutions **D** and **E**.

The time for solutions **C** and **D** have been entered in Table 2.1. The times are in seconds.

Table 2.1

solution of acid X	time taken for magnesium to disappear/s
C	42
D	>180
E	

(i) Fig. 2.1 shows the stopclock reading for solution **E**.

Record the reading on the stopclock in Table 2.1.

[1]



Fig. 2.1

(c) The student is told that acid **X** is hydrochloric acid.

He carries out one test on **X** to confirm the identity of the negative ion in **X**. He uses only chemical reagents from the list in (b) to do this.

Record in column one of Table 2.2 the chemical reagent he should use and in column two the expected observation.

Table 2.2

chemical reagent	observations

[1]

(d) The teacher suggests it would be difficult to carry out the experiment in (a) for concentrations of acid less than 0.001 mol/dm^3 .

Explain why the teacher is correct.

.....

.....[1]

3 A student measures the mass of a metre rule using a balancing method.

He uses a load L of 100g, a metre rule and a pivot.

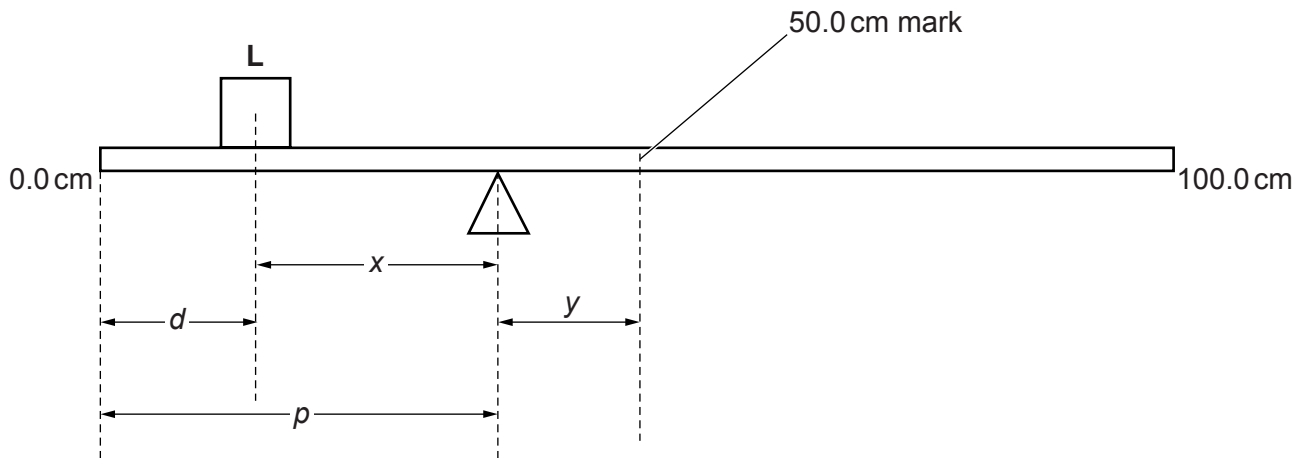

Fig. 3.1

- He places the load on the rule so that its centre is at a distance $d = 5.0$ cm from the zero end of the rule, as shown in Fig. 3.1.
- He adjusts the position of the pivot so that the rule balances on it.

(a) Fig. 3.2 shows the position of the pivot at balance.

Record in Table 3.1 on page 8, to the nearest 0.1 cm, the distance p from the pivot to the zero end of the rule. [1]

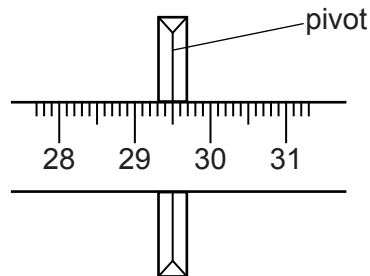

Fig. 3.2

- (b) The student repeats the procedure in (a) for values of d of 10.0 cm, 15.0 cm, 20.0 cm and 25.0 cm.

His results are given in Table 3.1.

Table 3.1

d/cm	p/cm	$x = (p - d)/\text{cm}$	$y = (50 - p)/\text{cm}$
5.0			
10.0	31.8	21.8	18.2
15.0	34.1		
20.0	36.4		
25.0	38.6		

For each value of d , calculate the distances x and y as shown in Table 3.1 using the equations shown. One has been done for you.

$$x = (p - d)$$

$$y = (50 - p)$$

Record in Table 3.1 your calculated values of x and y .

[2]

- (c) (i) On the grid provided plot a graph of y against x . You do **not** need to start your axes from the origin $(0, 0)$.

Draw the best-fit straight line.

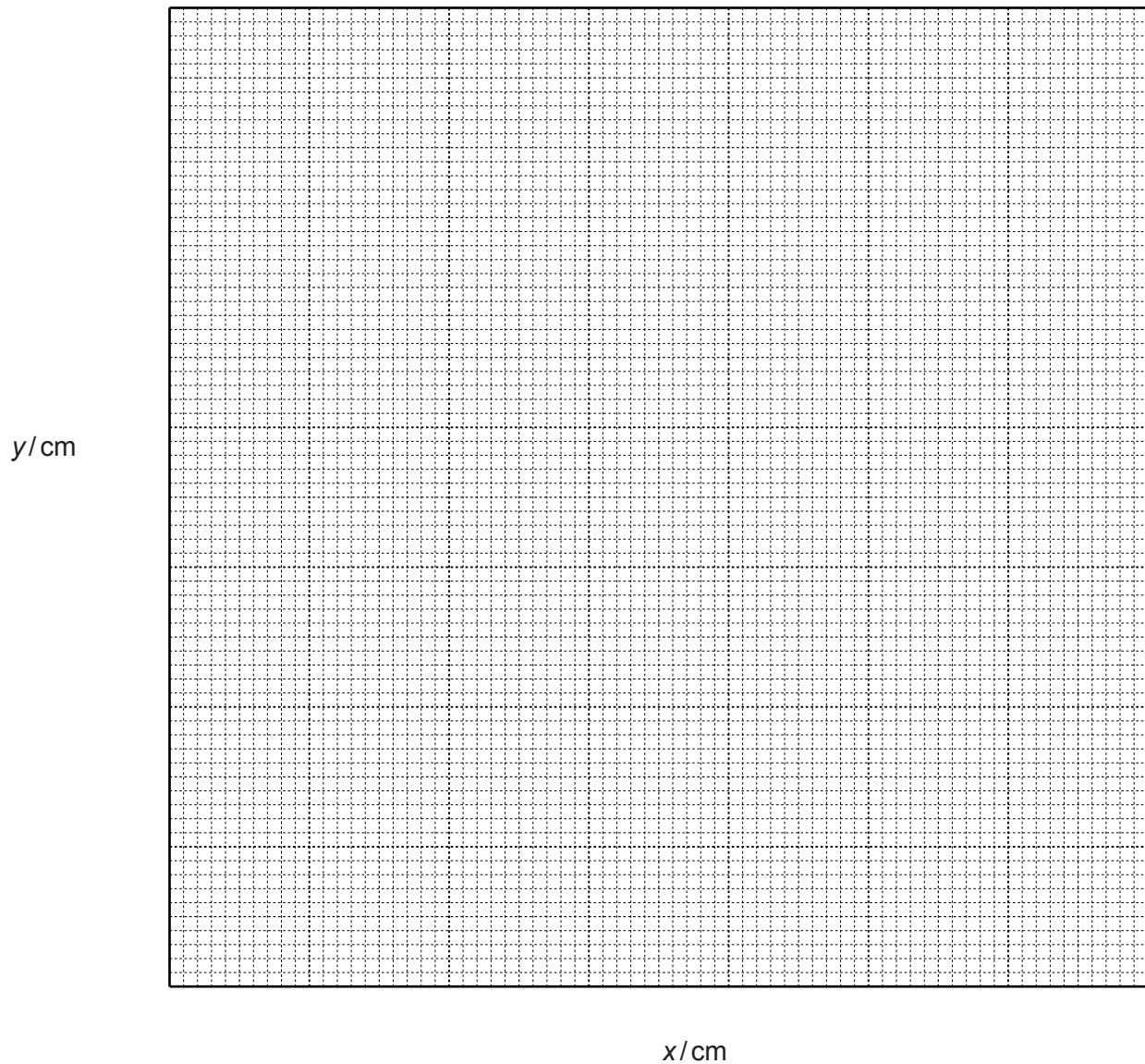

[3]

- (ii) Calculate the gradient of your line.

Show all working and indicate on your graph the values you chose to enable the gradient to be calculated.

gradient of line = [2]

10

- (d) The mass in grams of the metre rule is given by the equation shown.

$$\text{mass} = \frac{100}{\text{gradient}}$$

Use this equation to calculate the mass of the rule, giving your answer to an appropriate number of significant figures.

mass of rule =g [1]

- (e) The student now checks his result and measures the mass of the rule using a digital balance.

Suggest **one practical** reason why, despite carrying out the experiment with care, the value for the mass calculated in (d) may be different from the value recorded by the digital balance. Assume that the digital balance used is accurate.

.....
.....[1]

Please turn over for Question 4.

- 4 A student investigates whether plants need carbon dioxide for photosynthesis.

He sets up two experiments, **F** and **G**, as shown in Fig. 4.1. The plants have previously been destarched.

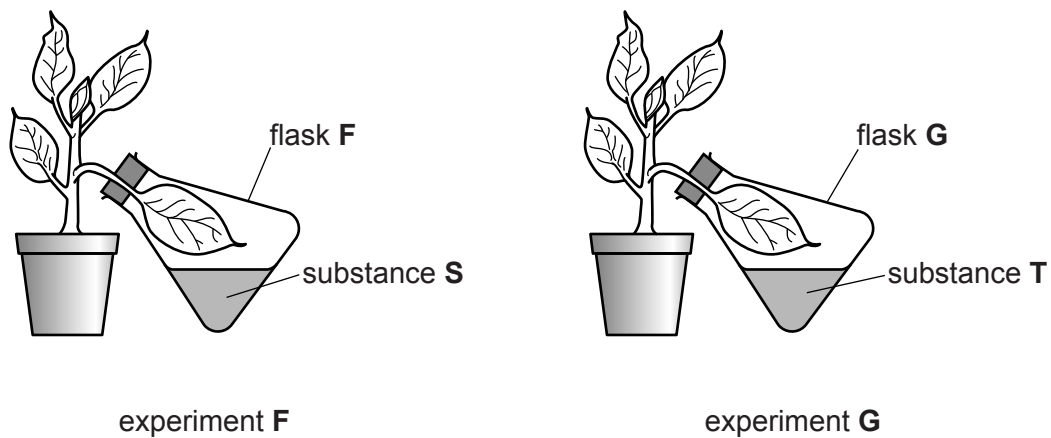

Fig. 4.1

- (a) Describe how the plants are destarched.

.....

.....

.....[2]

- (b) The student needs to remove carbon dioxide from flask **F**.

- (i) Name a **solid** or a **liquid** that can be used for substance **S** that would remove carbon dioxide from flask **F**.

.....[1]

- (ii) Suggest a suitable substance **T**, to make experiment **G** a control.

.....[1]

(c) After several hours, the student removes the leaves from the two flasks and tests them for starch.

(i) Describe in detail the procedure for testing a leaf for starch. In your answer, include any safety precautions.

.....
.....
.....
.....
.....
.....
..... [4]

(ii) Describe and explain the appearance of each leaf after testing for starch.

.....
.....
..... [2]

- 5 (a) A student investigates solid **M**, which is a green powder.

She places a portion of **M** in a beaker and adds some sulfuric acid.

She observes bubbles and a gas is evolved. The teacher says the gas evolved is carbon dioxide.

- (i) State the test the student could use to show that the gas is carbon dioxide. Give the positive result.

test

positive result [2]

- (ii) The student separates the mixture produced in (a)(i) to give a blue solution.

Draw a labelled diagram to show how she could produce the blue solution from the mixture.

[2]

(iii) The student pours the blue solution produced in (a)(ii) into three test-tubes.

To one of the test-tubes she adds aqueous ammonia in small amounts until there is no further change.

To the second test-tube she adds aqueous sodium hydroxide in small amounts until there is no further change.

Complete Table 5.1 with the expected observations that show the blue solution contains copper(II) ions.

Table 5.1

	reagent	
	aqueous ammonia	aqueous sodium hydroxide
observations on adding a small amount of reagent		
observations on adding an excess of reagent		

[3]

(b) Use the information from part (a) to identify solid **M**.

solid **M** is[1]

(c) The student uses the third test-tube of blue solution from (a)(iii) to show that the solution contains sulfate ions.

Describe how she shows that the solution contains sulfate ions. State any chemicals she should use and the observations for a positive result.

.....

[2]

- 6 (a) A student investigates how much thermal energy is produced by an electric heater.

She pours some water into a measuring cylinder.

She records the volume of water and places the water into a beaker.

Fig. 6.1 shows part of the measuring cylinder.

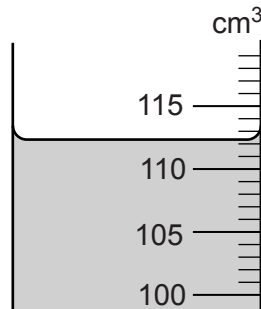

Fig. 6.1

- (i) Read the volume of water and record the value to the nearest cm^3 .

volume of water cm^3 [1]

The student places an electric heater in the beaker of water as shown in Fig. 6.2.

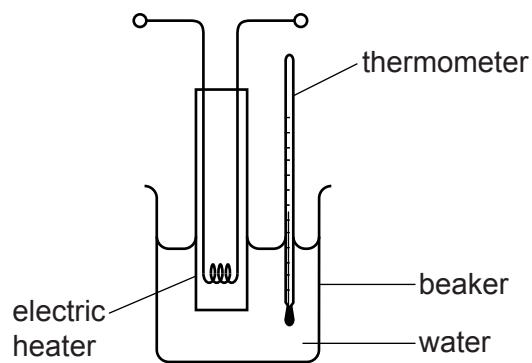

Fig. 6.2

(ii) Draw a circuit diagram, using appropriate circuit symbols, in Fig. 6.3. Include the following:

- an ammeter to measure the current in the heater
- a voltmeter to measure the potential difference across the heater
- a switch and a lamp in series with the heater.

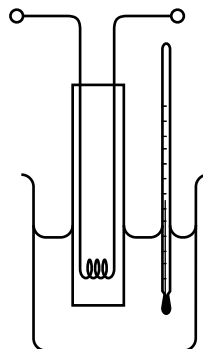
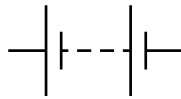

Fig. 6.3

[4]

- (iii) The student measures the temperature of the water. She closes the switch to turn on the heater.

After some time she opens the switch and measures the temperature of the hot water.

Record the values shown on the thermometers in Fig. 6.4 in the spaces below, and calculate the temperature rise ΔT .

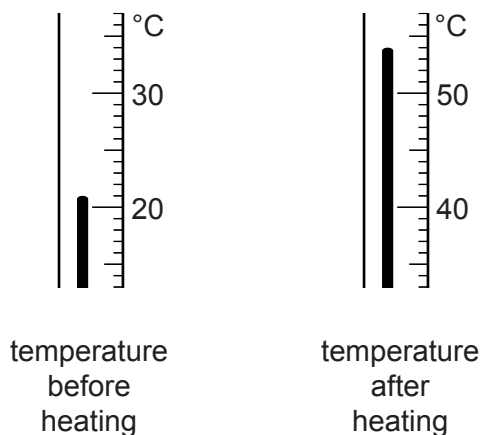

Fig. 6.4

temperature **after** heating°C

temperature **before** heating°C

ΔT °C [2]

- (iv) Calculate the energy gained, in kJ, by the water using the equation shown.

$$\text{energy gained} = \frac{M \times \Delta T \times 4.2}{1000}$$

M is the mass of water used and 1 cm^3 has a mass of 1 g.

energy gained = kJ [1]

- (b) The teacher says that not all the thermal energy produced by the heater results in a rise in the temperature of the water.

Suggest **two** other places to which the energy could be transferred.

1

2 [2]

BLANK PAGE

BLANK PAGE

Permission to reproduce items where third-party owned material protected by copyright is included has been sought and cleared where possible. Every reasonable effort has been made by the publisher (UCLES) to trace copyright holders, but if any items requiring clearance have unwittingly been included, the publisher will be pleased to make amends at the earliest possible opportunity.

To avoid the issue of disclosure of answer-related information to candidates, all copyright acknowledgements are reproduced online in the Cambridge International Examinations Copyright Acknowledgements Booklet. This is produced for each series of examinations and is freely available to download at www.cie.org.uk after the live examination series.

Cambridge International Examinations is part of the Cambridge Assessment Group. Cambridge Assessment is the brand name of University of Cambridge Local Examinations Syndicate (UCLES), which is itself a department of the University of Cambridge.