



Centre Number	Candidate Number	Name
---------------	------------------	------

UNIVERSITY OF CAMBRIDGE INTERNATIONAL EXAMINATIONS
International General Certificate of Secondary Education

CO-ORDINATED SCIENCES

0654/05

Paper 5 Practical Test

May/June 2006

2 hours

Candidates answer on the Question Paper.

Additional Materials: As listed in Instructions to Supervisors

READ THESE INSTRUCTIONS FIRST

Write your Centre number, candidate number and name on all the work you hand in.
Write in dark blue or black pen.
You may use a pencil for any diagrams, graphs or rough working.
Do not use staples, paper clips, highlighters, glue or correction fluid.

Answer **all** questions.
Chemistry practical notes for this paper are printed on page 12.
At the end of the examination, fasten all your work securely together.
The number of marks is given in brackets [] at the end of each question or part question.

For Examiner's Use	
1	
2	
3	
Total	

This document consists of **11** printed pages and **1** blank page.

- 1 This question is about two digestive enzymes, amylase and pepsin. Pepsin breaks down protein in the stomach. Amylase breaks down starch in the mouth and small intestine. This experiment will find out whether pH affects the activity of these enzymes.

Label six test-tubes with the numbers 1 to 6 and place them in a test-tube rack.

Pepsin Test

The enzyme will be added to a cloudy protein suspension. If the protein is digested it becomes clear.

Using clean syringes for each substance make up the first three test-tubes as follows:

- Put 2 cm³ protein solution into tubes 1, 2 and 3.
- Add 1 cm³ water to tube 1.
- Add 3 cm³ water to tube 3.
- Add 1 cm³ hydrochloric acid to tube 2.
- Add 2 cm³ pepsin solution to tubes 1 and 2.
- Put the tubes into the water bath provided.

Amylase Test

The enzyme will be added to a starch solution. If the starch is broken down, iodine will stay light brown when tested with the reaction mixture.

Prepare the next three tubes as follows:

- Put 2 cm³ starch solution into tubes 4, 5 and 6.
- Add 1 cm³ water to tube 4.
- Add 3 cm³ water to tube 6.
- Add 1 cm³ hydrochloric acid to tube 5.
- Add 2 cm³ amylase solution to tubes 4 and 5.
- Put these tubes in the water bath.

- (a) (i) Leave all the tubes in the water bath for 5 minutes. During this time complete the contents column for each tube in Fig. 1.1. [1]

tube number	contents	observations
1	protein, water, pepsin	
2		
3		
4		
5		
6		

Fig. 1.1

(ii) After the end of 5 minutes carry out the following.

- Remove all 6 test-tubes from the water bath and place them in the test-tube rack.
- Carefully look at tubes 1, 2 and 3 and record in Fig. 1.1 whether their appearance is **clear** or **cloudy**.
- Place 3 drops of iodine on a white tile making sure they are far apart from each other (see Fig. 1.2).

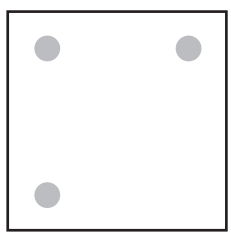

Fig. 1.2

- Dip a glass rod into tube 4. When you bring it out of the tube it will have a drop of the reaction mixture on it. Transfer this drop so that it mixes with one of the drops of iodine. Observe the colour and record it in Fig. 1.1.
- Wipe the glass rod clean with a paper towel. Test the contents of tubes 5 and 6 in the same way and record the results in Fig. 1.1. [4]

(b) (i) Which of the six tubes showed digestion?

..... [1]

(ii) Which enzyme worked better in conditions of low pH?

..... [1]

(iii) Explain your observations for tube 5 in terms of enzyme action.

..... [1]

(iv) Why were tubes 3 and 6 included in the experiment?

..... [1]

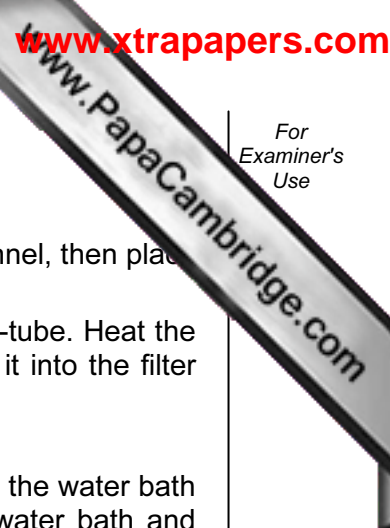

(c) This experiment is to find out if amylase is a protein.

- Using the piece of material provided, prepare a lining for the filter funnel, then place the lined funnel in a clean test-tube in a test-tube rack.
- Using a syringe, transfer 3 cm³ amylase solution into a different test-tube. Heat the amylase solution until it boils. Filter the boiled amylase by pouring it into the filter funnel.
- Allow the filtrate to cool for a few minutes.
- Add 1 cm³ acid and 2 cm³ pepsin to the filtrate. Put the test-tube into the water bath at 40 °C for 5 minutes. After this time remove the tube from the water bath and place it in the test-tube rack.

(i) Describe the appearance of the amylase after boiling.

.....

What had happened to the amylase?

..... [2]

(ii) Describe the appearance of the mixture after warming in the water bath at 40 °C. Explain what has happened.

appearance

.....

.....

explanation

.....

..... [2]

(iii) Give **two** pieces of evidence from the experiment that indicate that amylase is a protein.

.....

.....

..... [2]

2 You are going to find the density of plasticine by measuring the mass and volume by two different methods. The two sets of results for the mass, together with the result for volume will be used to calculate the density each time.

(a) Shape the plasticine into a cube or rectangular block. Use a ruler to find the dimensions of the block and record them in the space below. Your measurements should be in centimetres. Use these values to calculate the volume of the plasticine.

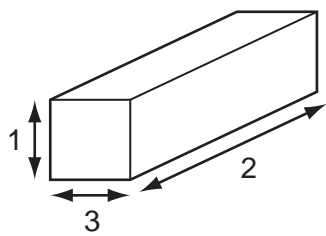

Fig. 2.1

measurements

1. cm 2. cm 3. cm

volume = cm³ [2]

(b) Weigh the block of plasticine to the nearest gram.

mass of plasticine = g [1]

(c) Calculate the density of plasticine from the figures obtained in (a) and (b). Show your working.

density = g/cm³ [1]

(d) You will now determine the volume of the same piece of plasticine by measuring the displacement of water in a measuring cylinder.

(i) Place enough water in the measuring cylinder to allow the plasticine to be totally immersed. Read and record the volume of water.

volume before adding plasticine = cm³

- (ii) Carefully place the plasticine into the water and record the new volume. Then alter the shape of the plasticine to allow it to fit into the measuring cylinder.

volume after adding plasticine = cm³

- (iii) Using these measurements, calculate the volume of the plasticine.

volume of plasticine = cm³ [1]

- (e) You are now going to find the mass of the plasticine by using a second method. You will need to remove it carefully from the measuring cylinder and dry off any excess water from its surface.

- (i) Balance the metre rule on the pivot and record the value of the balance point as shown in Fig. 2.2.

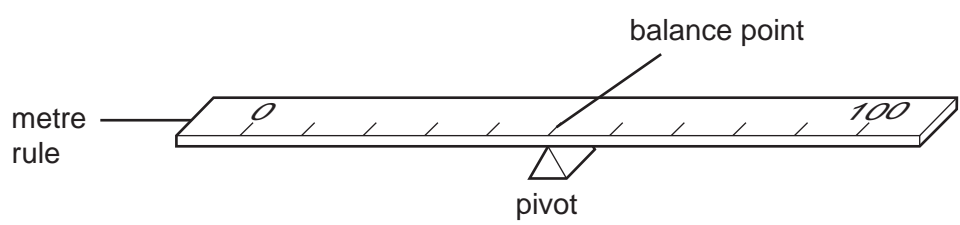

Fig. 2.2

balance point = cm [1]

- (ii) Hang the 25 g mass from the 10 cm mark on the rule. Record the distance, **d**₁, of the 10 cm mark from the pivot.

d₁ = cm

- (iii) Attach a thread to the plasticine and hang this on the other end of the rule. Adjust the position of the plasticine until the rule balances. Record the distance, **d**₂, from the pivot. See Fig. 2.3. Make sure the balance point is the same as in (e)(i).

d₂ = cm [1]

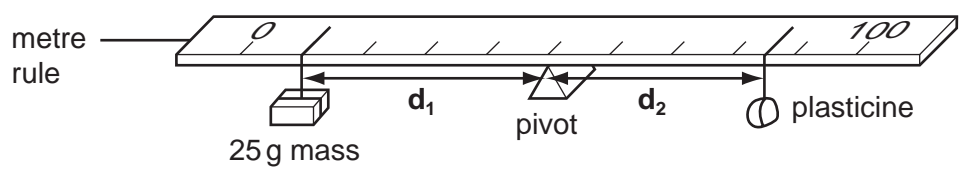

Fig. 2.3

(iv) Use the following equation to calculate the mass of the plasticine.

$$d_1 \times 25 = d_2 \times \text{mass of plasticine}$$

Show your working.

mass =g [2]

(f) Using the mass from (e)(iv) and the volume from (d)(iii), calculate the density of plasticine. Show your working.

density =g/cm³ [2]

(g) Which measurement of volume (a) or (d)(iii) is the more accurate?
Explain your answer.

.....
.....
..... [2]

(h) Briefly describe how you would find the density of plasticine at a temperature of 80°C.

.....
.....
..... [2]

3 You are going to find the volume of gas given off when substance X is heated.

- (a) Clamp the test-tube containing substance X and place in a stand. Place the burner containing the delivery tube in the test-tube. Place enough water in the trough to cover the end of the delivery tube.

Completely fill the measuring cylinder with water. Place your hand over the end, invert the cylinder and stand it in the trough of water before removing your hand. Clamp the cylinder in the stand.

Refer to Fig. 3.1 to see how the apparatus should appear.

The end of the delivery tube should be under the measuring cylinder. It may be necessary to hold this in place while heating is carried out.

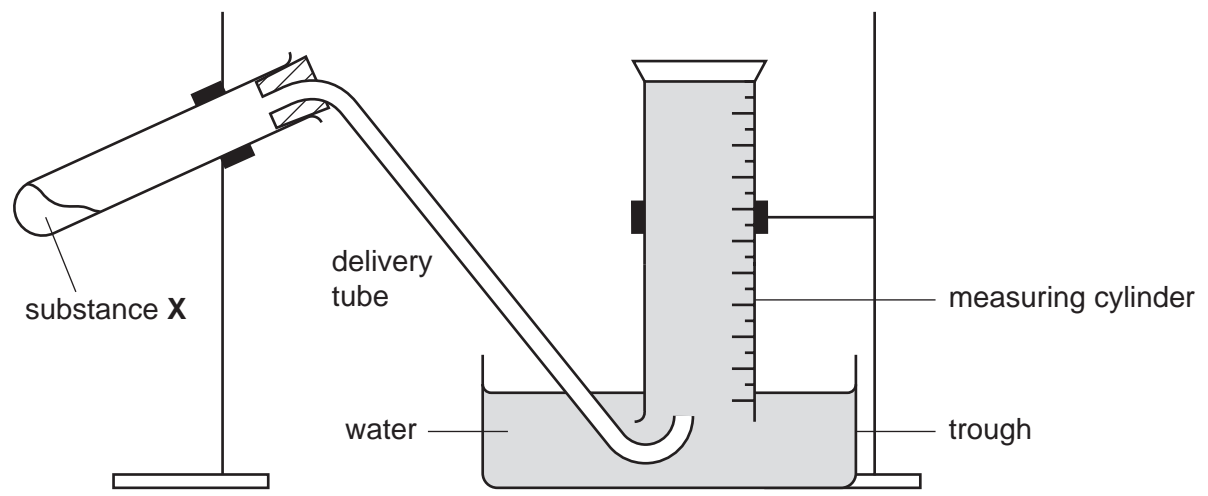

Fig. 3.1

Adjust the flame of the burner to about 10 cm high or less. Heat substance X and collect the bubbles in the cylinder. When there are no more bubbles, remove the delivery tube from the water and stop heating. You must make sure the delivery tube is out of the water before you stop heating to avoid water sucking back into the hot tube.

Leave the tube and contents to cool down. You will need the cooled solid for part (d).

- (i) Record the mass of solid X used.

mass =g [1]

- (ii) Record the volume of gas collected in the measuring cylinder.

volume of gas collected =cm³ [2]

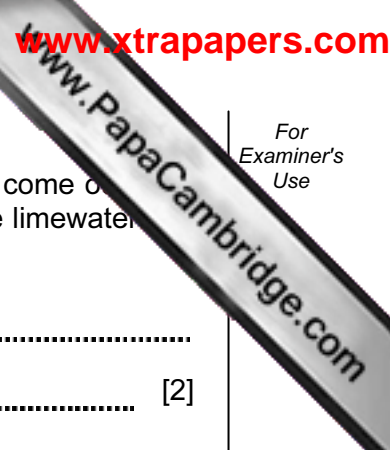

(b) (i) Remove the cylinder from the clamp. Allow any remaining water to come out. Add about 5 cm³ of limewater to the gas in the cylinder. Gently shake the limewater. Record any observation.

observation

name the gas identified by this test [2]

(ii) The first few bubbles collected were **not** the gas identified. What were they?

..... [1]

(c) Explain why "sucking back" may take place and why this would be dangerous.

.....
.....
..... [2]

(d) Dissolve a little of the cooled residue from the tube in which **X** was heated, in about 5 cm³ of water. Add a few drops of Universal Indicator. Record the colour and estimate the pH.

colour

pH = [2]

(e) You are to carry out two tests on a fresh sample of substance **X**. Dissolve substance **X** in about 10 cm³ of warm water.

(i) Place about 2 cm³ of the solution into a test-tube and add dilute hydrochloric acid. Record your observations.

observations

name of gas [2]

(ii) To another portion add a few drops of Universal Indicator. Record the colour and estimate the pH.

colour

pH = [1]

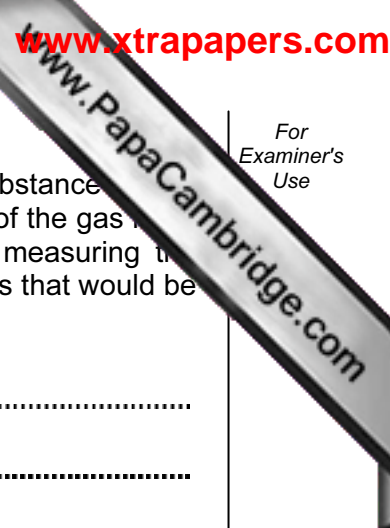

(f) The teacher calculated the expected volume of gas using the mass of substance. The volume actually collected was less than this volume. He said that some of the gas had dissolved in the water. Suggest another way of collecting and measuring the volume without using water. You should draw a diagram of any apparatus that would be used.

.....

.....

[2]

CHEMISTRY PRACTICAL NOTES

Test for anions

<i>anion</i>	<i>test</i>	<i>test result</i>
carbonate (CO_3^{2-})	add dilute acid	effervescence, carbon dioxide produced
chloride (Cl^-) [in solution]	acidify with dilute nitric acid, then add aqueous silver nitrate	white ppt.
nitrate (NO_3^-) [in solution]	add aqueous sodium hydroxide then aluminium foil; warm carefully	ammonia produced
sulphate (SO_4^{2-}) [in solution]	acidify then add aqueous barium chloride <i>or</i> aqueous barium nitrate	white ppt.

Test for aqueous cations

<i>cation</i>	<i>effect of aqueous sodium hydroxide</i>	<i>effect of aqueous ammonia</i>
ammonium (NH_4^+)	ammonia produced on warming	-
copper (II) (Cu^{2+})	light blue ppt., insoluble in excess	light blue ppt., soluble in excess giving a dark blue solution
iron(II) (Fe^{2+})	green ppt., insoluble in excess	green ppt., insoluble in excess
iron(III) (Fe^{3+})	red-brown ppt., insoluble in excess	red-brown ppt., insoluble in excess
zinc (Zn^{2+})	white ppt., soluble in excess giving a colourless solution	white ppt., soluble in excess, giving a colourless solution

Test for gases

<i>gas</i>	<i>test and test results</i>
ammonia (NH_3)	turns damp litmus paper blue
carbon dioxide (CO_2)	turns limewater milky
chlorine (Cl_2)	bleaches damp litmus paper
hydrogen (H_2)	"pops" with a lighted splint
oxygen (O_2)	relights a glowing splint

Permission to reproduce items where third-party owned material protected by copyright is included has been sought and cleared where possible. Every reasonable effort has been made by the publisher (UCLES) to trace copyright holders, but if any items requiring clearance have unwittingly been included, the publisher will be pleased to make amends at the earliest possible opportunity.

University of Cambridge International Examinations is part of the University of Cambridge Local Examinations Syndicate (UCLES), which is itself a department of the University of Cambridge.