



Cambridge International Examinations
Cambridge International General Certificate of Secondary Education

CANDIDATE
NAME

CENTRE
NUMBER

--	--	--	--	--

CANDIDATE
NUMBER

--	--	--	--



CO-ORDINATED SCIENCES

0654/61

Paper 6 Alternative to Practical

October/November 2014

1 hour

Candidates answer on the Question Paper.

No Additional Materials are required.

READ THESE INSTRUCTIONS FIRST

Write your Centre number, candidate number and name on all the work you hand in.

Write in dark blue or black pen.

You may use an HB pencil for any diagrams or graphs.

Do not use staples, paper clips, glue or correction fluid.

DO NOT WRITE IN ANY BARCODES.

Answer **all** questions.

Electronic calculators may be used.

You may lose marks if you do not show your working or if you do not use appropriate units.

At the end of the examination, fasten all your work securely together.

The number of marks is given in brackets [] at the end of each question or part question.

This document consists of **21** printed pages and **3** blank pages.

BLANK PAGE

- 1 A student is investigating the relationship between yeast activity and temperature. Active yeast produces a gas which may appear as a foam.
- The student stirs a yeast and sugar suspension and immediately measures out 20 cm^3 into each of two large test-tubes.
 - He places one test-tube into beaker **A** containing some water which he maintains at about 20°C .
 - He places the other test-tube into beaker **B** containing some water which he maintains at about 40°C .

The apparatus is shown in Fig. 1.1.

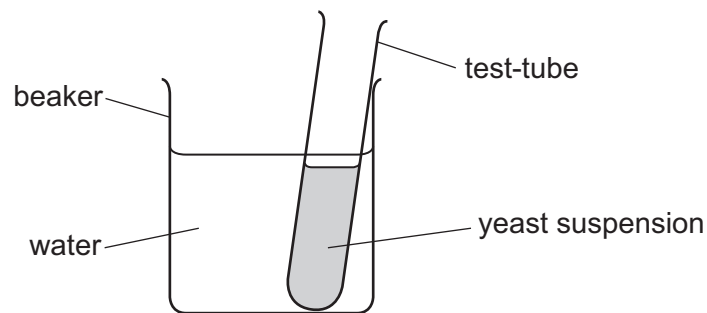

Fig. 1.1

- He measures the temperature of the water in each beaker.
 - The temperature of beaker **A** is 19.0°C .
- (a) The thermometer in Fig. 1.2 shows the temperature in beaker **B**.

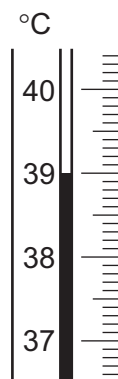

Fig. 1.2

Read and record this temperature.

beaker **B** = $^\circ\text{C}$ [1]

- He uses a ruler to measure the height h of the liquid (including any foam) in each test-tube at regular intervals. The arrangement is shown in Fig. 1.3.

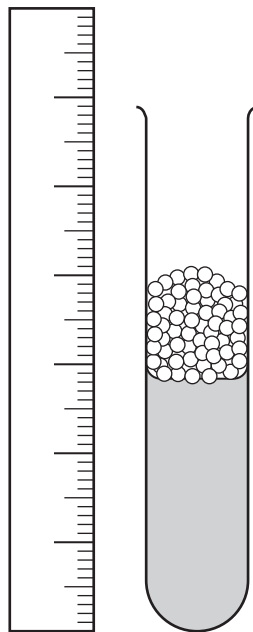

Fig. 1.3

- (b) On Fig. 1.3, draw a labelled arrow to show the height h . Mark clearly the top and bottom of the measurement. [1]
- The student measures the height h in each test-tube at 2 minute intervals for ten minutes. During this time he maintains the temperatures of the beakers. He records his measurements in Table 1.1.

Table 1.1

time / mins	beaker A height h / mm	beaker B height h / mm
0	40	40
2	40	62
4	40	75
6	41	90
8	42	98
10	44	105

(c) On the grid provided, plot graphs of height h for each beaker against time. Draw best-fit lines and label them **A** and **B**.

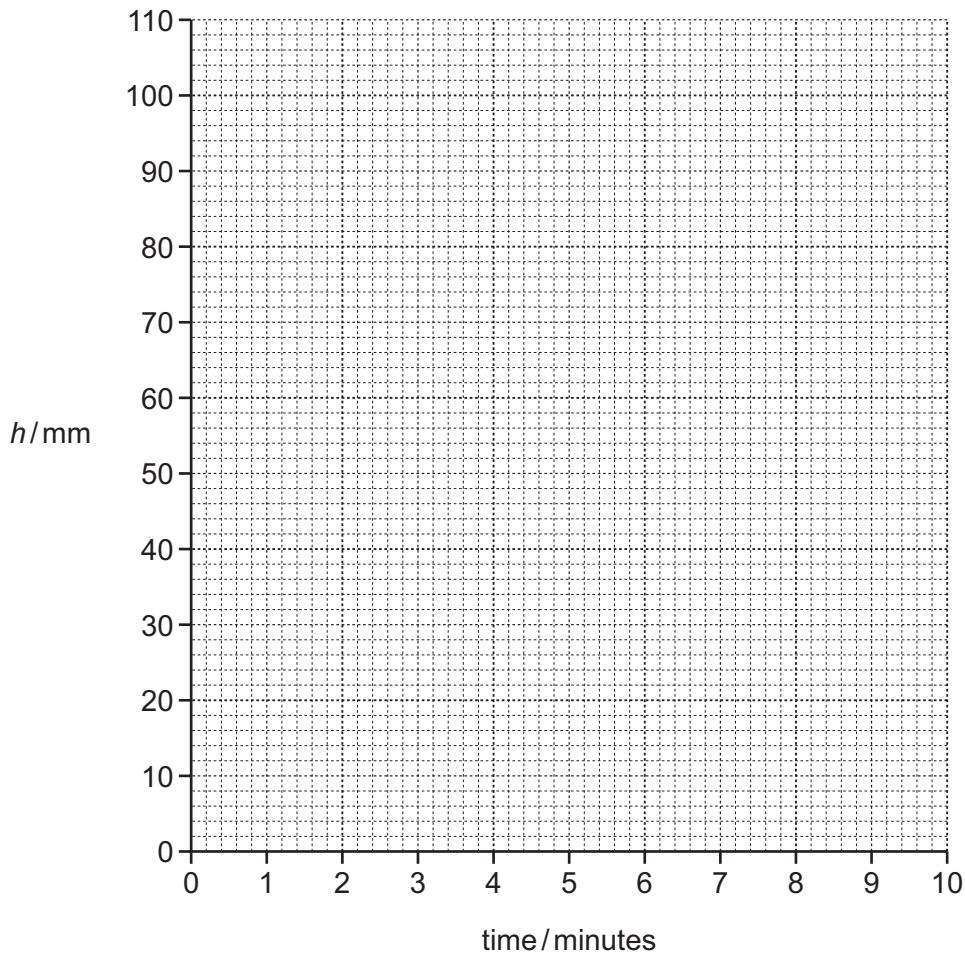

[4]

(d) A teacher says that yeast activity stops when the temperature of the yeast is too high.

Plan and describe an investigation based on the experiment the student carried out to find out the minimum temperature at which yeast activity stops due to temperature being too high.

.....

.....

.....

.....

.....

.....

.....

[4]

BLANK PAGE

- 2 A student has been given a sample of solid **Y** which is a mixture of three compounds each containing a different metal.

He has been told to carry out six tests to identify the compounds contained in solid **Y**.

Test 1

Place the sample of solid **Y** in a beaker and add about 25 cm³ distilled water. Stir the mixture and then filter it. Keep the filtrate and residue for **Tests 2, 3 and 4**.

Record your observations.

The student has recorded his observations for **Test 1**.

The filtrate is colourless, the residue is brown-black.

- (a) Complete Fig. 2.1 to show how, in **Test 1**, the mixture is separated into filtrate and residue. Label your diagram.

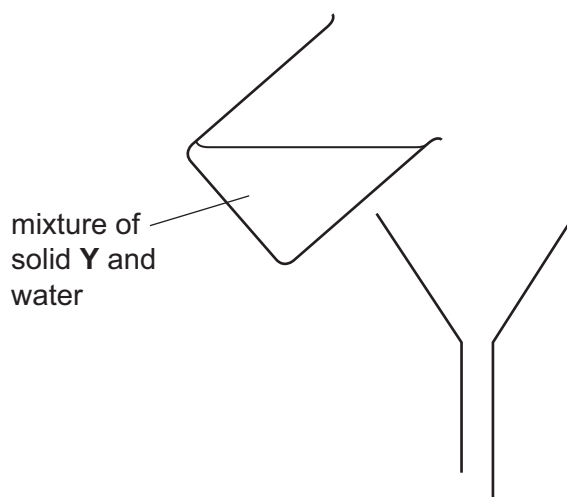

Fig. 2.1

[2]

The student carries out **Test 2** and writes his observations.

Test 2

To about 2 cm³ of the filtrate from **Test 1** slowly add 20 cm³ sodium hydroxide solution. Stir the mixture.

Record your observations.

observations

White precipitate at first which dissolves to form a
colourless solution.

(b) The student thinks that the filtrate contains zinc ions, Zn²⁺.

He carries out **Test 3**. He has not written his observations.

Suggest what the student observes for **Test 3** if the filtrate does contain Zn²⁺ ions.

Test 3

To about 2 cm³ of the filtrate from **Test 1** slowly add 20 cm³ ammonia solution. Stir the mixture.

Record your observations.

observations

.....
..... [2]

(c) The student carries out **Test 4** and **Test 5** and records his observations.

Test 4

Place some of the residue from **Test 1** into a beaker and add dilute hydrochloric acid. When the reaction has finished, filter the mixture.

Record your observations.

observations

*The mixture bubbled and a gas is given off. The
filtrate is blue and the residue is black.*

Test 5

To 2 cm³ of the filtrate from **Test 4**, add excess dilute sodium hydroxide. Stir the mixture.

Record your observations.

observations

A light blue precipitate is formed.

The student thinks that solid **Y** contains copper(II) carbonate. In **Test 4**, this compound reacts with the hydrochloric acid.

- (i) Suggest a test on the gas that was given off in **Test 4** that will confirm that solid **Y** contains a carbonate.

.....
..... [2]

- (ii) To confirm that the filtrate from **Test 4** contains copper(II) ions, the student slowly adds excess ammonia solution.

State **two** observations he makes to confirm that copper(II) ions are present.

1
.....
2
..... [2]

- (d) The student has found out that solid **Y** contains zinc ions and copper(II) ions. He carries out **Test 6**.

He thinks that the third compound present in solid **Y** contains iron.

Test 6

Dissolve the residue from **Test 4** in nitric acid. Slowly add ammonia solution until it is in excess.

Record your observations.

Describe his observations for **Test 6** that suggest that iron(III) ions are present in the solution of the residue from **Test 4**.

.....
..... [2]

Please turn over for Question 3.

- 3 A student is investigating the relationship between the length of a piece of wire and its electrical resistance. She sets up the circuit shown in Fig. 3.1.

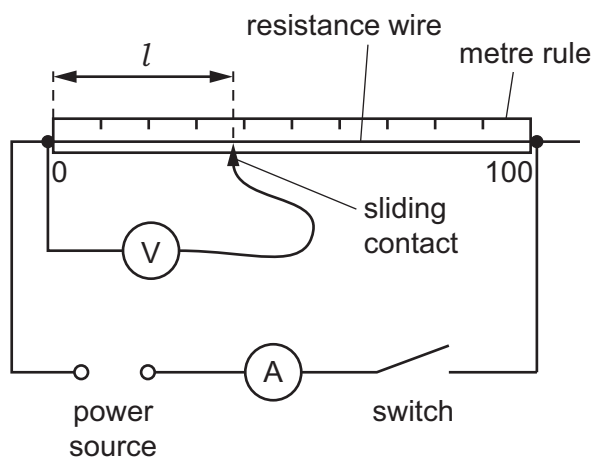

Fig. 3.1

Method

- She closes the switch.
- She places the sliding contact on the wire so that $l = 10.0$ cm.
- She reads the ammeter and voltmeter and records the values of current and voltage in Table 3.1.
- She opens the switch.
- She repeats the procedure for $l = 25.0$, 40.0 , 70.0 and 85.0 cm of wire.

- (a) Fig. 3.2 shows the dials of the voltmeter for the voltage across 25.0 cm and 40.0 cm of wire.

Read the dials and record the values, to the nearest 0.1 V, in Table 3.1.

[2]

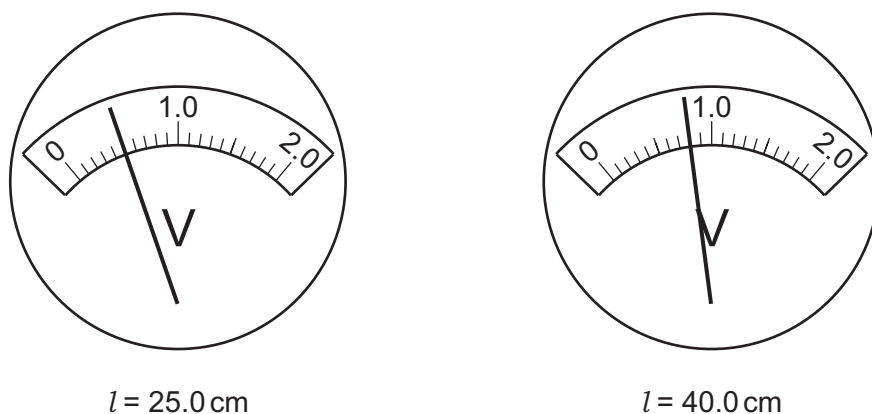

Fig. 3.2

Table 3.1

length, l /cm	current/A	voltage/V	resistance/ohms
10.0	0.32	0.2	0.6
25.0	0.32		
40.0	0.32		
70.0	0.32	1.4	4.4
85.0	0.32	1.7	5.3

(b) Use the equation

$$\text{resistance} = \frac{\text{voltage}}{\text{current}}$$

to calculate, to the nearest 0.1 ohm, the resistances of 25.0 cm and 40.0 cm of wire. Record them in Table 3.1.

[2]

(c) (i) On the grid provided, plot a graph of resistance/ohms (vertical axis) against length/cm. Include the point (0,0) in your graph. Draw the best-fit straight line.

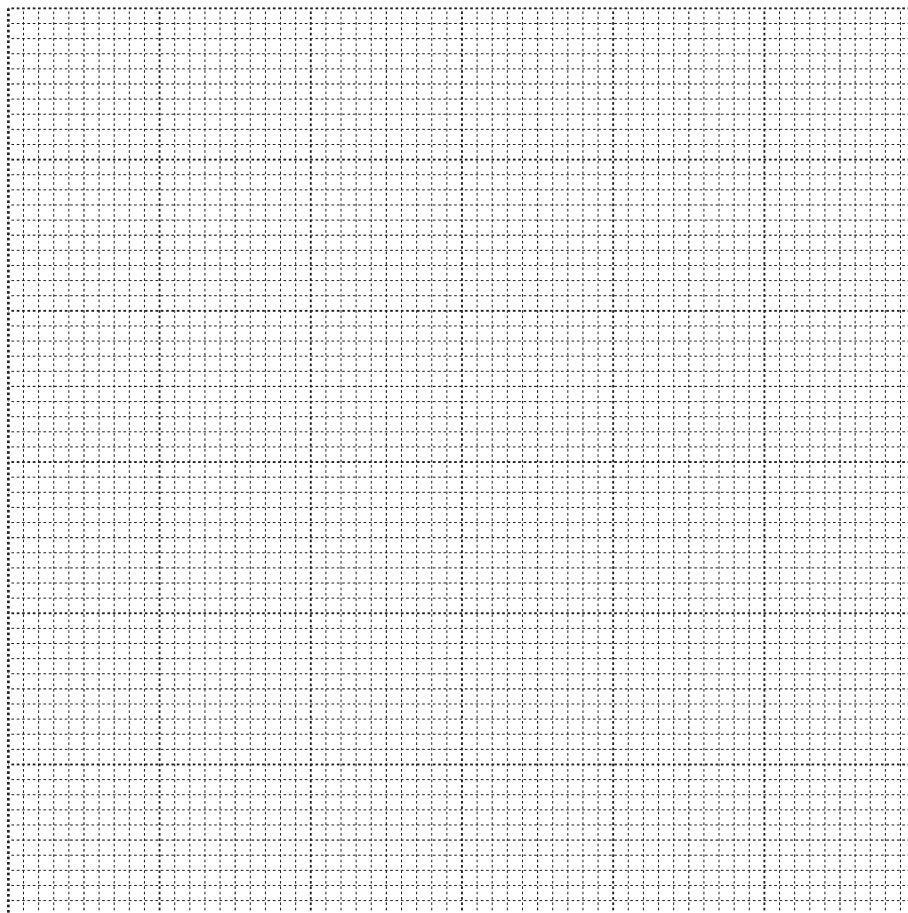

(ii) Use your graph to state the relationship between the length of wire and the resistance.

.....
..... [1]

(d) The teacher tells the student that the values of resistance may not be reliable unless the current is switched off between readings.

Suggest a reason for this.

.....
.....
..... [1]

(e) The student wants to try the same experiment using a wire made of the same alloy but thicker.

Suggest how the results of this new experiment will differ from those in Table 3.1.

.....
.....
..... [1]

- 4 (a) A student wants to find out the largest volume of air that he can breathe out in one breath. This is called the *vital capacity*.

Describe how he could use the apparatus in Fig. 4.1 to do this.

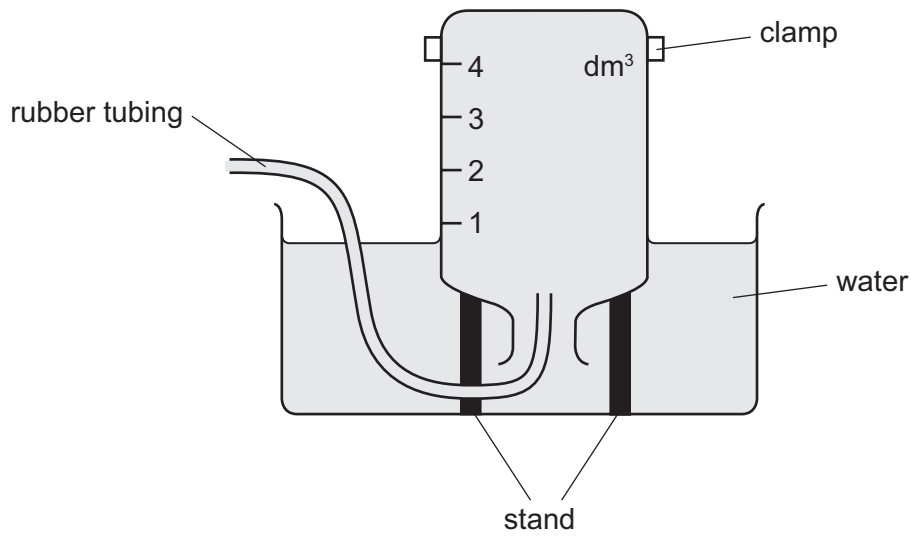

Fig. 4.1

.....

.....

.....

..... [3]

- (b) Suggest how he could check the reliability of his results.

.....

.....

..... [2]

(c) (i) The teacher suggests that there is a relationship between a person's height and vital capacity. Plan an experiment to test this hypothesis.

.....
.....
.....
.....
.....
..... [2]

(ii) Describe how you would present your results to show any relationship. You may wish to use this space to draw a suitable table.

.....
..... [1]

(d) Another student has two gas jars. One jar contains exhaled air and the other jar contains inhaled air. She places a lighted candle inside each jar.

Suggest and explain the difference in results from the two samples of air.

.....
.....
..... [2]

- 5 A student is investigating the boiling and freezing points of a liquid.

Fig. 5.1 shows the apparatus he uses to find the boiling point.

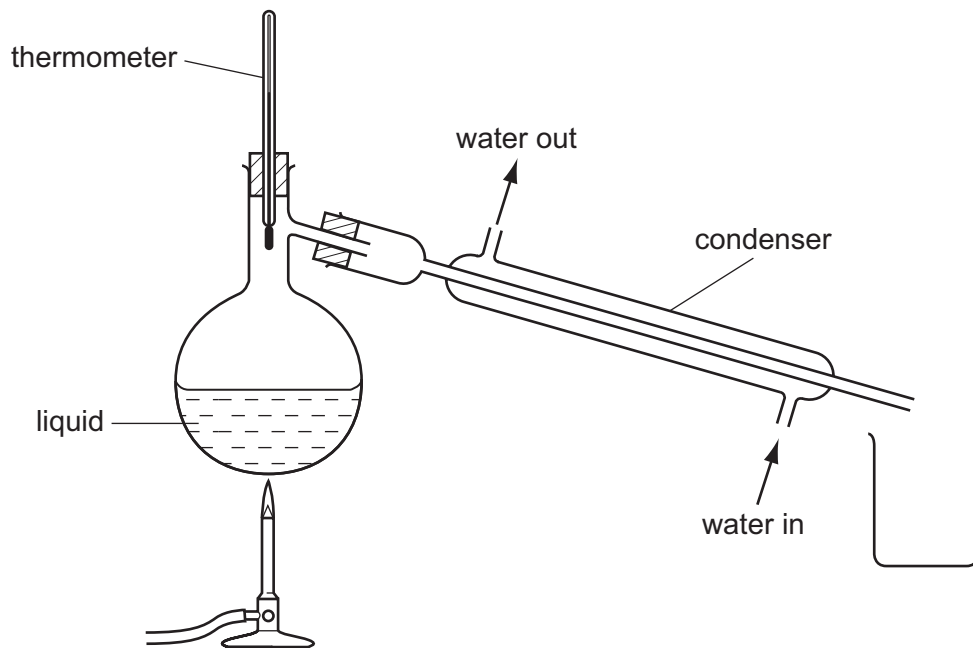

Fig. 5.1

- (a) (i) He observes the liquid in the apparatus while he gently heats the flask with a Bunsen burner flame. The liquid and its vapour are colourless and transparent.

Suggest **one** observation that will tell the student when the reading on the thermometer shows the boiling point of the liquid.

.....
 [1]

- (ii) Explain why the temperature of the liquid does not rise above its boiling point even though the flask is still being heated. Use the words *thermal energy* in your answer.

.....

 [2]

(iii) Fig. 5.2 shows the thermometer scale at the point when the liquid boils.



Fig. 5.2

Complete the sentence.

The boiling point of the liquid is °C [1]

(iv) Explain what happens to the molecules of vapour when they enter the condenser. Use the word *energy* in your answer.

.....
 [2]

Fig. 5.3 shows the apparatus the student uses to find the freezing point of the liquid.

He places some of the liquid in a large test-tube surrounded by ice. He measures the temperature of the liquid every 30 seconds and plots the graph shown in Fig. 5.4.

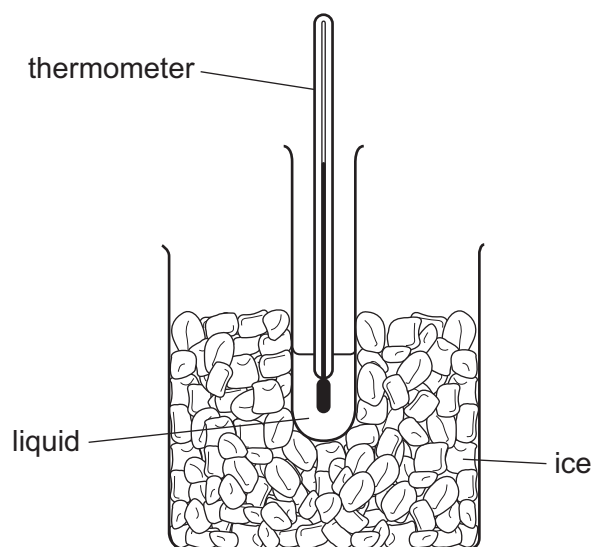

Fig. 5.3

19

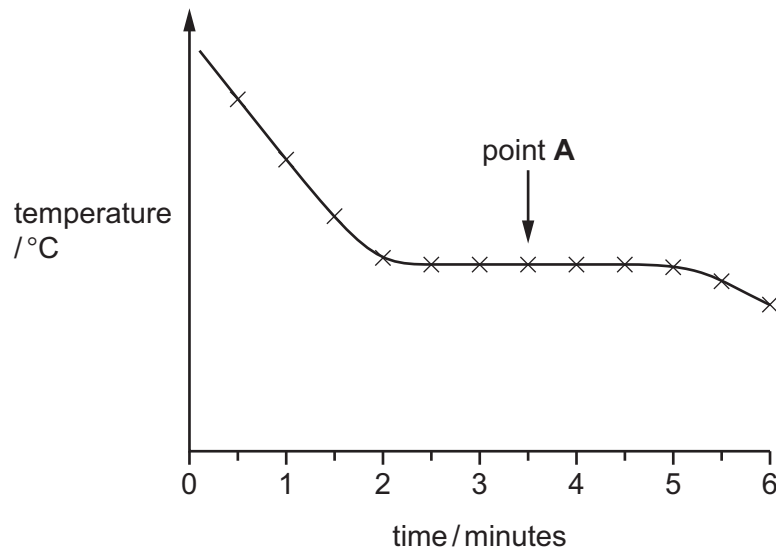

Fig. 5.4

- (b) (i) The student also watches the liquid in the tube while it cools.

State what he observes in the test-tube when the liquid reaches the freezing point.

..... [1]

- (ii) Fig. 5.5 shows the thermometer corresponding to point **A** on the graph. This is the temperature at which the liquid freezes.

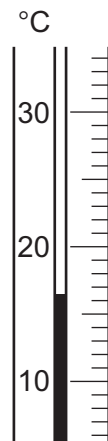

Fig. 5.5

Read the scale and record the temperature of point **A** to the nearest 0.5 °C.

freezing point of the liquid = °C [1]

- (iii) Explain why the temperature stays constant at the temperature of point **A** on the graph for several minutes even though the contents of the test-tube have not yet cooled to 0 °C, the temperature of the ice.

Your answer must include a reference to the thermal energy of the molecules of the liquid.

.....

.....

..... [2]

- 6 The science teacher asks his students to find the height of the steep cliff shown in Fig. 6.1.

The students must find t , the time taken for a rock to fall from the top of the cliff to the bottom. They can use this value of t to calculate the height of the cliff.

Student **A** holds the rock, ready to drop it over the edge of the cliff. Student **B** has a timer which can measure to the nearest 0.1 s.

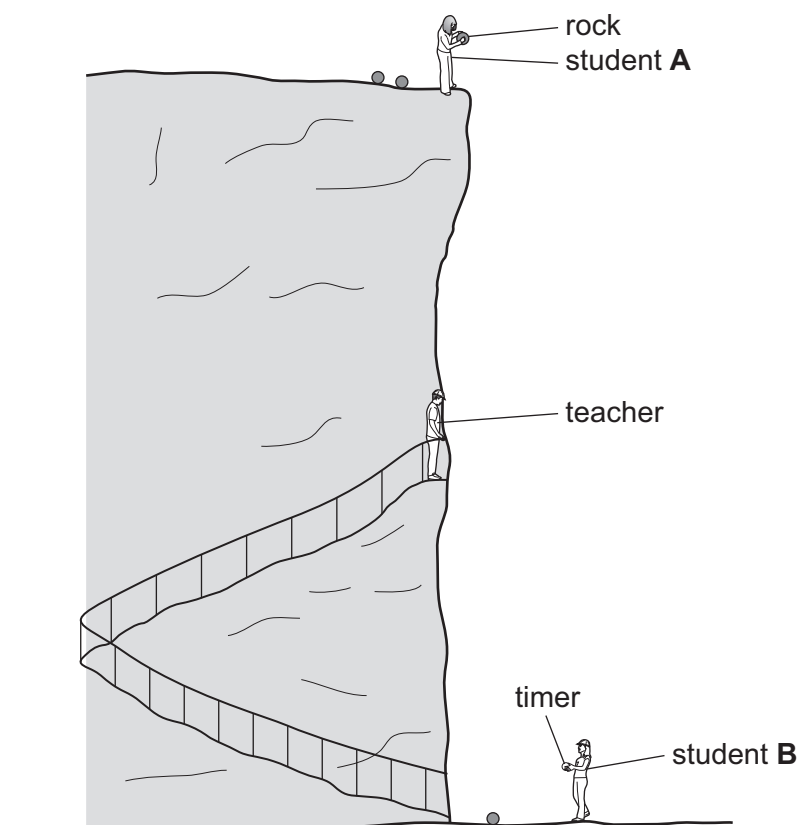

Fig. 6.1

Method

- Student **A** shouts to student **B**, calling “3, 2, 1, 0”.
- When student **A** calls “0” he releases the rock.
- When student **B** hears the count of “0” he starts the timer.
- When the rock hits the ground student **B** stops the timer and records the timer reading in Table 6.1.
- They repeat the experiment three more times. Student **B** does not reset the timer to zero between repeats.

- (a) Fig. 6.2 shows the readings on the timer when the rock hits the ground for experiments 3 and 4. Remember that student **B** does not reset the timer to zero between the experiments.



experiment 3
rock hits ground



experiment 4
rock hits ground

Fig. 6.2

Table 6.1

experiment number	1	2	3	4
timer reading when rock hits ground / s	3.2	6.5		
timer reading when rock is released / s	0	3.2		
t , time taken for the rock to fall / s	3.2	3.3		

- (i) Use the timer readings shown in Fig. 6.2 to complete the first row of Table 6.1. [1]
- (ii) Complete the second row of Table 6.1. [1]
- (iii) Calculate the times taken for the rock to fall in experiments 3 and 4 and complete the third row of Table 6.1. [2]

- (b) (i) The students calculate the height of the cliff using g , the acceleration due to gravity, equal to 9.8 m/s^2 and the time t taken for the rock to fall.

Calculate h , the height of the cliff, using the value of t obtained in experiment 2.

Use the formula shown below.

$$h = \frac{1}{2} \times 9.8 \times t^2$$

h , the height of the cliff = m [2]

- (ii) Explain why it might be better, when calculating h , to use an average of the four values of t instead of one of the values.

.....
.....
..... [2]

- (c) The method used by the students gives a value of h that is less than the actual height of the cliff. The teacher tells them to do the experiment again, using a different method.

This time, the teacher shouts to the students from a ledge at equal distances from both students (See Fig. 6.1). The teacher counts down to zero, calling “3, 2, 1, 0.”

Student **A** releases the rock and student **B** starts the timer when they hear the teacher call “0”.

Student **B** stops the timer when the rock hits the ground, as before.

Explain why this method will give a more accurate value for t , the time for the rock to fall.

.....
.....
.....
..... [2]

BLANK PAGE

Permission to reproduce items where third-party owned material protected by copyright is included has been sought and cleared where possible. Every reasonable effort has been made by the publisher (UCLES) to trace copyright holders, but if any items requiring clearance have unwittingly been included, the publisher will be pleased to make amends at the earliest possible opportunity.

Cambridge International Examinations is part of the Cambridge Assessment Group. Cambridge Assessment is the brand name of University of Cambridge Local Examinations Syndicate (UCLES), which is itself a department of the University of Cambridge.