



Cambridge IGCSE™

CO-ORDINATED SCIENCES

0654/12

Paper 1 Multiple Choice (Core)

October/November 2022

45 minutes

You must answer on the multiple choice answer sheet.

You will need: Multiple choice answer sheet
Soft clean eraser
Soft pencil (type B or HB is recommended)

INSTRUCTIONS

- There are **forty** questions on this paper. Answer **all** questions.
- For each question there are four possible answers **A, B, C** and **D**. Choose the **one** you consider correct and record your choice in soft pencil on the multiple choice answer sheet.
- Follow the instructions on the multiple choice answer sheet.
- Write in soft pencil.
- Write your name, centre number and candidate number on the multiple choice answer sheet in the spaces provided unless this has been done for you.
- Do **not** use correction fluid.
- Do **not** write on any bar codes.
- You may use a calculator.

INFORMATION

- The total mark for this paper is 40.
- Each correct answer will score one mark.
- Any rough working should be done on this question paper.
- The Periodic Table is printed in the question paper.

This document has **16** pages. Any blank pages are indicated.



- 1 Which characteristic of living organisms involves chemical reactions that break down nutrient molecules to release energy?
- A excretion
 - B nutrition
 - C reproduction
 - D respiration
- 2 What is found in plant cells but **not** in animal cells?
- A cell membrane
 - B cell wall
 - C nucleus
 - D cytoplasm
- 3 Glycerol is a component of which large molecules?
- A fats
 - B glycogen
 - C proteins
 - D starch
- 4 Which statement about enzymes is correct?
- A They are made from fat molecules.
 - B They are used up in a reaction.
 - C They speed up reactions.
 - D They are not affected by temperature.

3

- 5 A plant with variegated leaves is destarched. A strip of black paper is attached to both sides of a leaf and the plant is placed in the light for 24 hours.

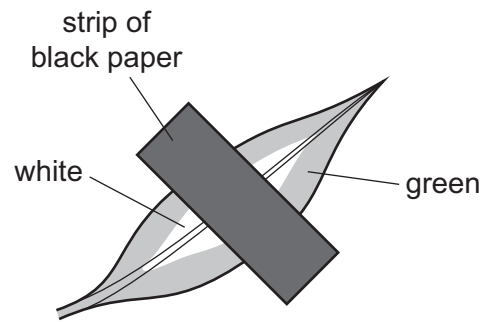

The leaf is then tested for starch.

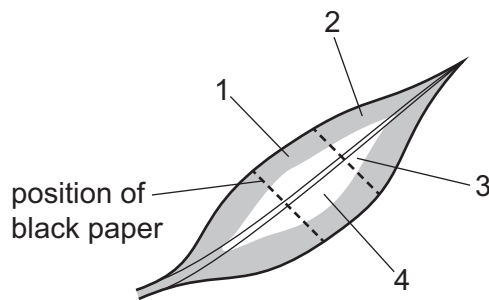

key

- 1 green under paper
- 2 green in the light
- 3 white in the light
- 4 white under paper

Which areas of the leaf stain blue-black with iodine?

- A** 1 and 4 **B** 1 only **C** 2 and 3 **D** 2 only

- 6 The diagram shows part of the human alimentary canal.

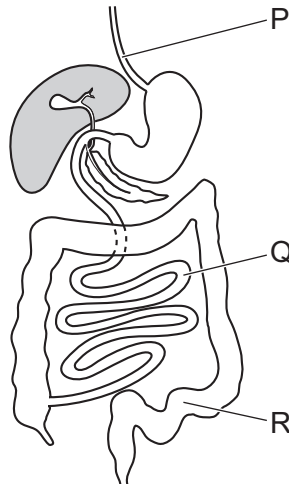

Which row identifies P, Q and R?

	P	Q	R
A	oesophagus	large intestine	stomach
B	stomach	small intestine	large intestine
C	stomach	large intestine	small intestine
D	oesophagus	small intestine	large intestine

- 7 The diagrams represent sections through a root, a stem and a leaf mid-rib, not drawn to the same scale.

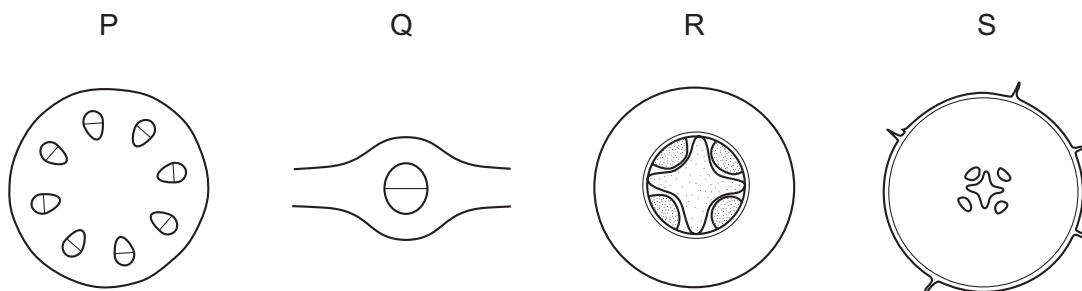

In which row are the sections correctly identified?

	root	stem	leaf
A	P	S	R
B	Q	R	S
C	R	P	Q
D	S	Q	P

- 8 Which diagram of a cell shows the correct movement of substances for the process of aerobic respiration?

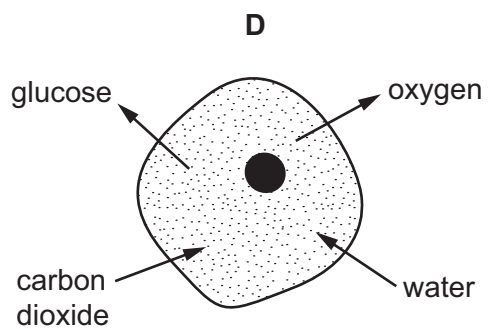
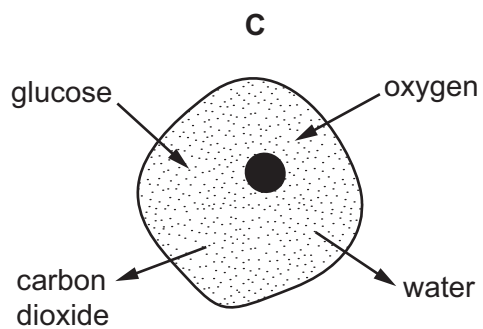
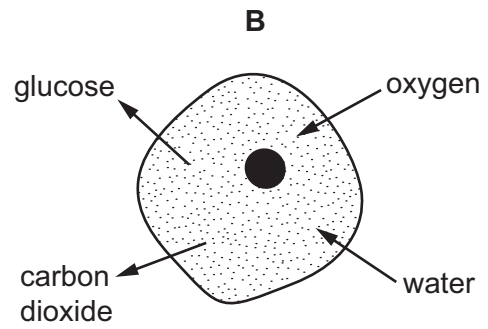
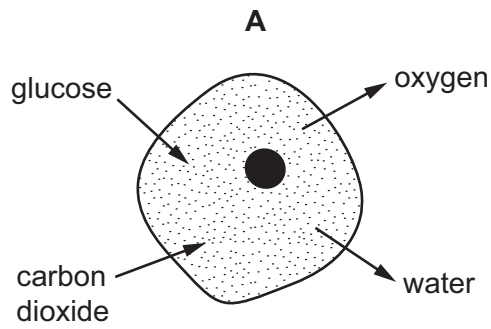

- 9 Which row shows a person's response to a 'fight or flight' situation?

	breathing rate / breaths per minute	pulse rate / beats per minute
A	12	70
B	12	140
C	18	70
D	18	140

10 Aphids are insects. The information shown describes part of the lifecycle of the aphid.

stage 1 In the spring, wingless females reproduce without fertilisation to produce many female offspring.

stage 2 In late summer, both males and females are produced. The female's eggs are fertilised by the male's sperm.

Which row shows the type of reproduction occurring at stages 1 and 2?

	stage 1	stage 2
A	asexual	asexual
B	asexual	sexual
C	sexual	asexual
D	sexual	sexual

11 The size of tomatoes is an inherited characteristic with a range of phenotypes between two extremes.

What best describes this?

- A** continuous variation
- B** discontinuous variation
- C** natural selection
- D** selective breeding

12 What is a producer in a food web?

- A** an organism that gets its energy by digesting plants
- B** an organism that makes its own food using light energy
- C** an organism that obtains energy from digested animals
- D** an organism that gets its energy from dead or waste organic matter

13 What is an undesirable effect of deforestation?

- A** It increases the oxygen concentration of the atmosphere.
- B** It leads to erosion and loss of soil.
- C** It makes land available for agriculture.
- D** It pollutes the air with methane.

14 Which change is represented by the diagram?

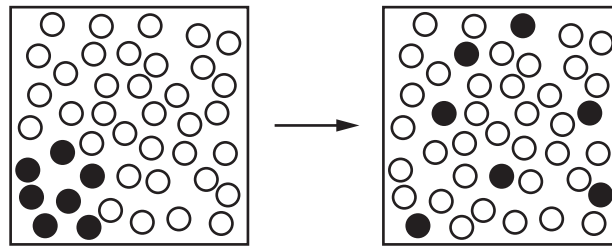

- A** condensation
B diffusion
C evaporation
D solidification
- 15 An atom of an element contains 9 protons, 10 neutrons and 9 electrons.
What is the nucleon number (mass number) of this element?
- A** 9 **B** 10 **C** 19 **D** 28
- 16 There are three times as many hydrogen atoms as carbon atoms in one molecule of hydrocarbon X.
What is the formula of X?
- A** CH₄ **B** C₂H₄ **C** C₂H₆ **D** C₂H₅OH
- 17 Which process is used to produce sodium and chlorine from the compound sodium chloride?
- A** chromatography
B cracking
C distillation
D electrolysis

18 The temperature change as the result of a chemical reaction may go up or down.

	temperature	type of reaction
1	decreases	endothermic
2	increases	endothermic
3	increases	exothermic
4	decreases	exothermic

Which rows about reactions are correct?

- A** 1 and 3 **B** 1 and 4 **C** 2 and 3 **D** 2 and 4

19 Two separate experiments X and Y are used to investigate the rate of the reaction between equal masses of calcium carbonate and excess dilute hydrochloric acid.

The volume of carbon dioxide given off is measured over time.

A graph of the results is shown.

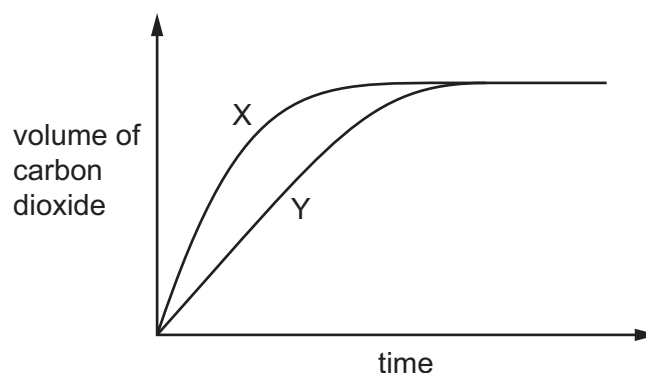

Which statement explains the difference between experiments X and Y?

- A** A catalyst is added to Y.
B A higher temperature is used in Y.
C Larger pieces of calcium carbonate are used in X.
D The acid is more concentrated in X.

20 Indigestion is caused by excess hydrochloric acid in the stomach.

Which substance can be used to neutralise the acid?

	substance	pH
A	vinegar	4
B	orange juice	6
C	water	7
D	baking powder	9

21 Which statements about the elements in Group VII of the Periodic Table are correct?

- 1 Only one of them is a liquid at room temperature.
- 2 Their colours become darker down the group.
- 3 Their melting points and boiling points decrease down the group.
- 4 They are all metallic elements called halogens.

A 1 and 2 **B** 1 and 4 **C** 2 and 3 **D** 3 and 4

22 Filament lamps require an inert atmosphere.

Which gas is used to fill these lamps?

- A** argon
- B** helium
- C** hydrogen
- D** oxygen

23 Alloys are formed by dissolving one metal in another.

Alloys are1..... .

.....2..... alloys conduct electricity.

Which words complete gaps 1 and 2?

	1	2
A	compounds	All
B	compounds	Some
C	mixtures	All
D	mixtures	Some

24 Metal X is extracted from its ore by heating the ore with carbon.

Which statement explains why carbon is used?

- A Carbon is a non-metal.
- B Carbon is more reactive than X.
- C Carbon reacts with oxygen in the air.
- D Carbon is less reactive than X.

25 Which row shows the relative abundance of the gases in clean air?

	most abundant	—————>	least abundant
A	nitrogen	argon	oxygen
B	nitrogen	oxygen	argon
C	oxygen	carbon dioxide	nitrogen
D	oxygen	nitrogen	carbon dioxide

26 What is **not** a use of limestone?

- A manufacture of calcium oxide
- B neutralising industrial waste products
- C purifying water
- D treating acidic soil

27 Which fractions obtained by the fractional distillation of petroleum are used as fuels?

- 1 bitumen
- 2 diesel oil
- 3 gasoline
- 4 refinery gas

- A 1 and 2 only B 3 and 4 only C 1, 2 and 3 D 2, 3 and 4

28 The diagram is the speed–time graph for a moving object.

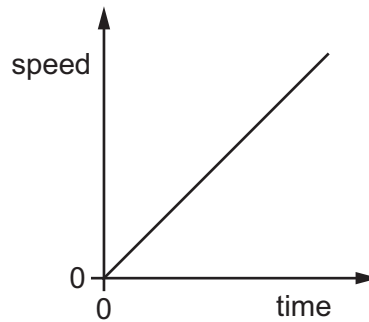

What happens to the acceleration of the object during the time represented by the graph?

- A It decreases.
 - B It increases.
 - C It is greater than zero and stays constant.
 - D It is zero and stays constant.
- 29 A metal has a density of 10 g/cm^3 . A solid, cuboid block of this metal has the dimensions shown.

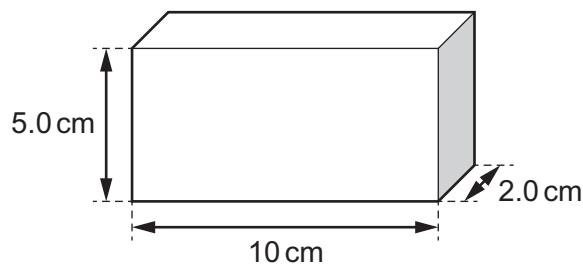

What is the mass of the block?

- A 2.0g
 - B 10g
 - C 200g
 - D 1000g
- 30 An object is travelling at constant speed in a straight line. There is no resultant force on the object.
- What happens to the object?
- A It continues at constant speed but changes direction.
 - B It continues at constant speed in the same direction.
 - C Its speed decreases but it continues in the same direction.
 - D Its speed increases but it continues in the same direction.

31 Two forklift trucks P and Q lift identical loads through the same vertical height.

Truck P takes a greater time than truck Q to lift the load.

Which statement is correct?

- A Truck P does more work than truck Q.
- B Truck P produces more power than truck Q.
- C Truck Q does more work than truck P.
- D Truck Q produces more power than truck P.

32 From which type of energy is electrical energy transferred in a hydroelectric power station?

- A chemical potential energy
- B elastic potential (strain) energy
- C gravitational potential energy
- D nuclear energy

33 A hot metal ball is placed in a small hollow in a piece of wood. Two thermometers are placed equal distances from the ball, one at position P and one at position Q.

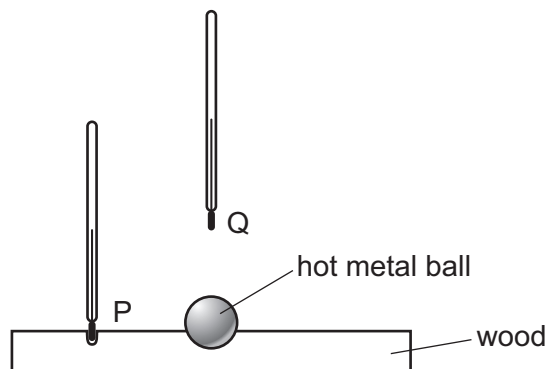

Which thermometer gives the higher reading and why?

	higher reading	reason
A	thermometer at P	the air conducts heat sideways, not upwards
B	thermometer at P	the wood conducts heat sideways, not upwards
C	thermometer at Q	convection carries heat upwards, not sideways
D	thermometer at Q	infrared rays always carry heat upwards, not sideways

- 34 An object is placed at a certain distance from a converging lens. This distance is greater than twice the focal length of the lens. The principal focus on each side of the lens is marked F and two rays from the top of the object are shown.

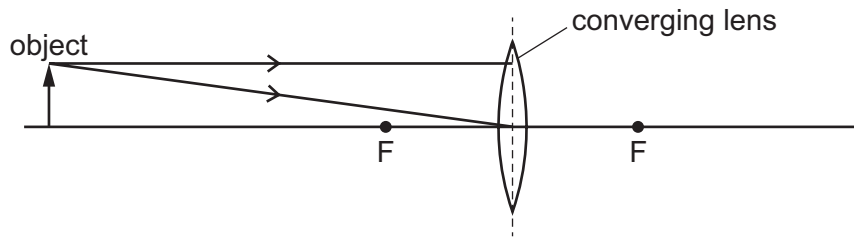

Which statement about the image formed is correct?

- A** The image is diminished and inverted.
B The image is diminished and upright.
C The image is enlarged and inverted.
D The image is enlarged and upright.
- 35 Which group shows electromagnetic waves in order of increasing frequency (lowest frequency first)?
- A** gamma-rays → X-rays → ultraviolet waves
B microwaves → infrared waves → gamma-rays
C ultraviolet waves → radio waves → infrared waves
D X-rays → radio waves → microwaves
- 36 Which type of magnet can be switched on and off many times per second?
- A** an electromagnet only
B a permanent magnet only
C both electromagnets and permanent magnets
D neither electromagnets or permanent magnets
- 37 A plastic rod is rubbed with a cloth causing a negative charge on the rod.

Which statements are correct?

- 1 The rod gains electrons.
- 2 The cloth loses electrons.
- 3 The cloth becomes positively charged.

- A** 1 and 2 only **B** 1 and 3 only **C** 2 and 3 only **D** 1, 2 and 3

38 X, Y and Z are combinations of identical resistors.

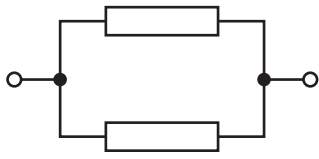

X



Y

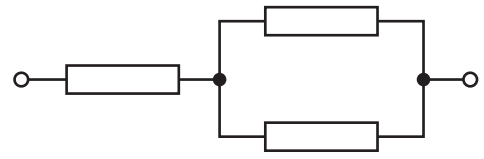

Z

The combinations are put in order of decreasing resistance (largest resistance to smallest resistance).

What is this order?

- A** $Y \rightarrow X \rightarrow Z$ **B** $Y \rightarrow Z \rightarrow X$ **C** $Z \rightarrow X \rightarrow Y$ **D** $Z \rightarrow Y \rightarrow X$

39 The maximum current in a food mixer during normal use is 3.1 A.

What is the most suitable rating for a fuse used to protect the mixer?

- A** 1A **B** 3A **C** 5A **D** 8A

40 The diagrams represent pairs of nuclei of some atoms.

Which pair shows nuclei of different isotopes of the same element?

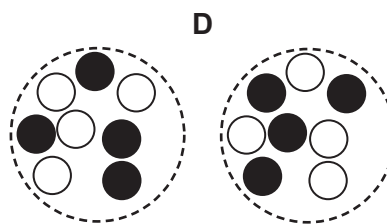
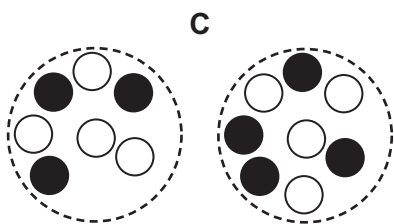
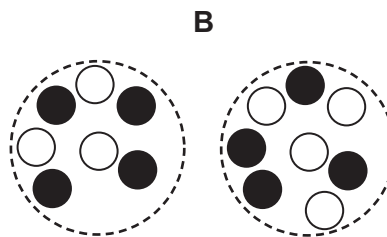
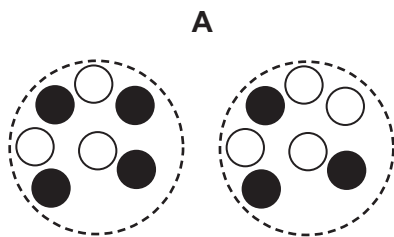

key
 ○ neutron
 ● proton

BLANK PAGE

Permission to reproduce items where third-party owned material protected by copyright is included has been sought and cleared where possible. Every reasonable effort has been made by the publisher (UCLES) to trace copyright holders, but if any items requiring clearance have unwittingly been included, the publisher will be pleased to make amends at the earliest possible opportunity.

To avoid the issue of disclosure of answer-related information to candidates, all copyright acknowledgements are reproduced online in the Cambridge Assessment International Education Copyright Acknowledgements Booklet. This is produced for each series of examinations and is freely available to download at www.cambridgeinternational.org after the live examination series.

Cambridge Assessment International Education is part of Cambridge Assessment. Cambridge Assessment is the brand name of the University of Cambridge Local Examinations Syndicate (UCLES), which is a department of the University of Cambridge.

The Periodic Table of Elements

Group																		
I	II	III										IV	V	VI	VII	VIII		
3 Li lithium 7	4 Be beryllium 9	<div style="border: 1px solid black; padding: 5px; text-align: center;"> Key atomic number atomic symbol name relative atomic mass </div>										5 B boron 11	6 C carbon 12	7 N nitrogen 14	8 O oxygen 16	9 F fluorine 19	10 Ne neon 20	
11 Na sodium 23	12 Mg magnesium 24											13 Al aluminium 27	14 Si silicon 28	15 P phosphorus 31	16 S sulfur 32	17 Cl chlorine 35.5	18 Ar argon 40	
19 K potassium 39	20 Ca calcium 40	21 Sc scandium 45	22 Ti titanium 48	23 V vanadium 51	24 Cr chromium 52	25 Mn manganese 55	26 Fe iron 56	27 Co cobalt 59	28 Ni nickel 59	29 Cu copper 64	30 Zn zinc 65	31 Ga gallium 70	32 Ge germanium 73	33 As arsenic 75	34 Se selenium 79	35 Br bromine 80	36 Kr krypton 84	
37 Rb rubidium 85	38 Sr strontium 88	39 Y yttrium 89	40 Zr zirconium 91	41 Nb niobium 93	42 Mo molybdenum 96	43 Tc technetium —	44 Ru ruthenium 101	45 Rh rhodium 103	46 Pd palladium 106	47 Ag silver 108	48 Cd cadmium 112	49 In indium 115	50 Sn tin 119	51 Sb antimony 122	52 Te tellurium 128	53 I iodine 127	54 Xe xenon 131	
55 Cs caesium 133	56 Ba barium 137	57–71 lanthanoids	72 Hf hafnium 178	73 Ta tantalum 181	74 W tungsten 184	75 Re rhenium 186	76 Os osmium 190	77 Ir iridium 192	78 Pt platinum 195	79 Au gold 197	80 Hg mercury 201	81 Tl thallium 204	82 Pb lead 207	83 Bi bismuth 209	84 Po polonium —	85 At astatine —	86 Rn radon —	
87 Fr francium —	88 Ra radium —	89–103 actinoids	104 Rf rutherfordium —	105 Db dubnium —	106 Sg seaborgium —	107 Bh bohrium —	108 Hs hassium —	109 Mt meitnerium —	110 Ds darmstadtium —	111 Rg roentgenium —	112 Cn copernicium —	114 Fl flerovium —	116 Lv livermorium —	—	—	—	—	—

lanthanoids	57 La lanthanum 139	58 Ce cerium 140	59 Pr praseodymium 141	60 Nd neodymium 144	61 Pm promethium —	62 Sm samarium 150	63 Eu europium 152	64 Gd gadolinium 157	65 Tb terbium 159	66 Dy dysprosium 163	67 Ho holmium 165	68 Er erbium 167	69 Tm thulium 169	70 Yb ytterbium 173	71 Lu lutetium 175
actinoids	89 Ac actinium —	90 Th thorium 232	91 Pa protactinium 231	92 U uranium 238	93 Np neptunium —	94 Pu plutonium —	95 Am americium —	96 Cm curium —	97 Bk berkelium —	98 Cf californium —	99 Es einsteinium —	100 Fm fermium —	101 Md mendelevium —	102 No nobelium —	103 Lr lawrencium —

The volume of one mole of any gas is 24 dm³ at room temperature and pressure (r.t.p.).