



UNIVERSITY OF CAMBRIDGE INTERNATIONAL EXAMINATIONS
International General Certificate of Secondary Education

21ST CENTURY SCIENCE (EXTENDED)

0608/02

Paper 2 Multiple Choice

October/November 2009

1 hour

Additional Materials: Multiple Choice Answer Sheet
Soft clean eraser
Soft pencil (type B or HB is recommended)

* 2 4 6 0 1 9 4 6 5 8 *

READ THESE INSTRUCTIONS FIRST

Write in soft pencil.
Do not use staples, paper clips, highlighters, glue or correction fluid.
Write your name, Centre number and candidate number on the Answer Sheet in the spaces provided unless this has been done for you.

There are **forty** questions on this paper. Answer **all** questions. For each question there are four possible answers **A, B, C** and **D**.
Choose the **one** you consider correct and record your choice in **soft pencil** on the separate Answer Sheet.

Read the instructions on the Answer Sheet very carefully.

Each correct answer will score one mark. A mark will not be deducted for a wrong answer.
Any rough working should be done in this booklet.
You may use a calculator.

This document consists of **16** printed pages and **4** blank pages.



2

1 What does the structure labelled X represent?

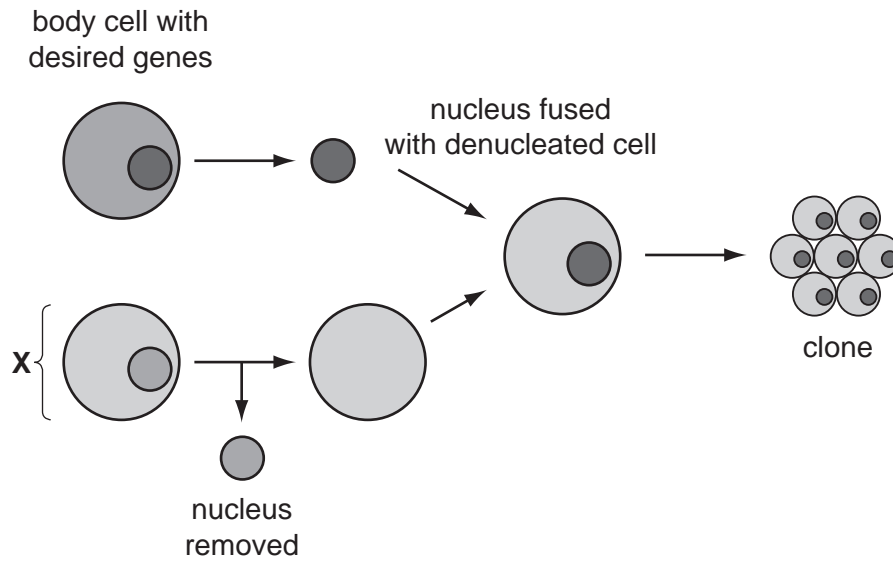

- A bacteria
- B egg cell
- C male gamete
- D zygote

2 Why is it difficult to design a vaccine against HIV?

- A The virus contains DNA.
- B The virus is made of protein.
- C The virus multiplies slowly.
- D The virus mutates rapidly.

3

3 Ten samples of bacteria from a hospital were tested with antibiotic X.

The table shows the percentage of the bacteria that were killed in each sample.

sample	percentage of bacteria killed
1	70
2	63
3	71
4	77
5	85
6	65
7	64
8	75
9	72
10	69

What are the reasons for the differences in percentages?

- 1 the antibiotic was tested for safety and effectiveness using human cells grown in the laboratory
- 2 the bacteria in different parts of the hospital vary
- 3 the method used caused the results to vary slightly
- 4 the patients in the hospital always complete their course of antibiotic

A 1 and 2

B 2 and 3

C 1 and 4

D 3 and 4

4

4 The body makes an antibody to recognise a particular microorganism.

Which graph shows the production of the antibodies after the body is exposed to a microorganism for a second time?

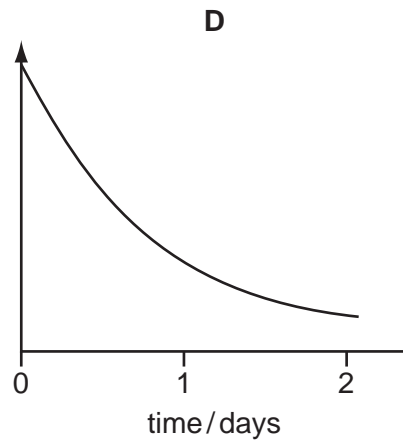
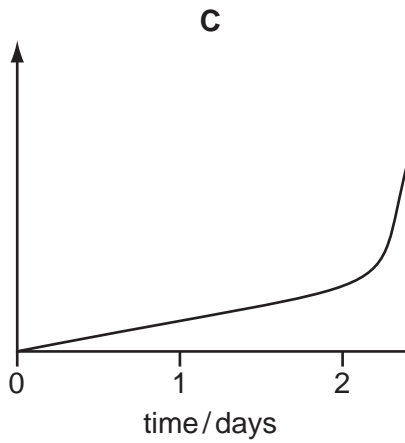
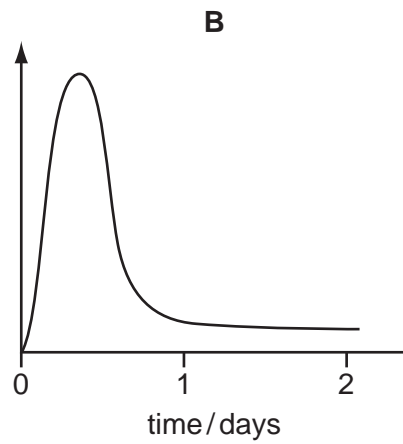
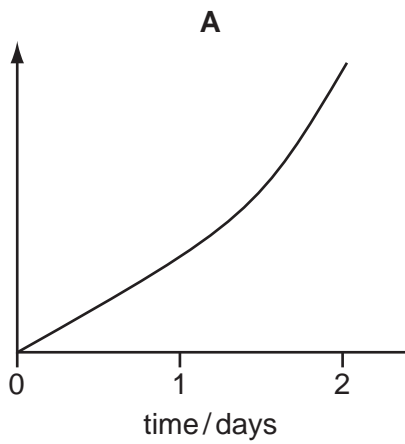

5 The diagram shows a plant cell.

Which structure contains genes?

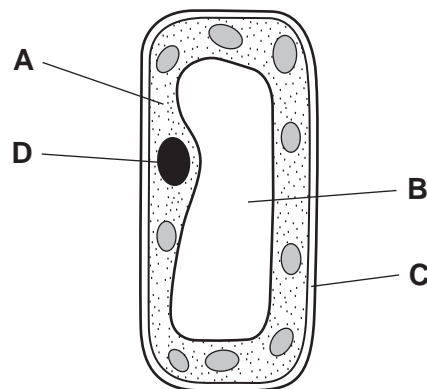

- 6 Rocks which are made in an atmosphere with no oxygen are often dark grey in colour. Rocks which are made in an atmosphere with oxygen are often red in colour.

One view of the origin of life on Earth is that the first organisms did not need oxygen to live and that the oxygen in the atmosphere was released by later organisms.

Which statements are consistent with this view?

	young rocks made recently	old rocks made when the first organisms lived
A	dark grey rocks	dark grey rocks
B	dark grey rocks	red rocks
C	red rocks	dark grey rocks
D	red rocks	red rocks

- 7 Which diagram represents human evolution?

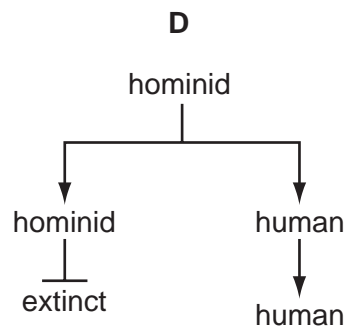
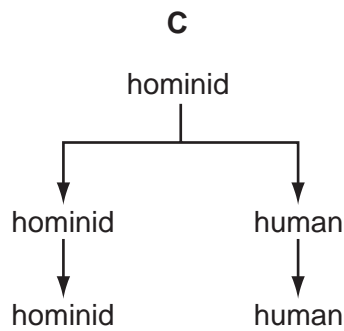
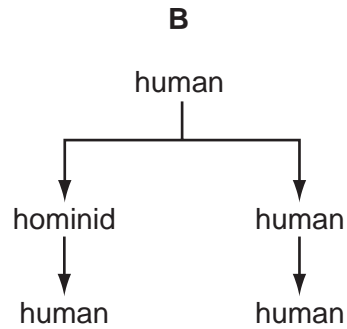
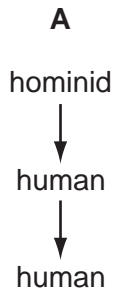

8 Which is a feature of evolution by natural selection?

	variation	competition	increased chance of survival	selective breeding	increased number of individuals with certain characteristics in later generations
A	✓	x	✓	✓	x
B	x	x	x	✓	✓
C	✓	✓	x	✓	✓
D	✓	✓	✓	x	✓

9 Which row shows the sex chromosomes in the body cells and in the sex cells in a man?

	body cells	sex cells
A	XY	XY
B	XY	X or Y
C	XX	XX
D	XX	X

10 What is the chance of the second child being a carrier of cystic fibrosis?

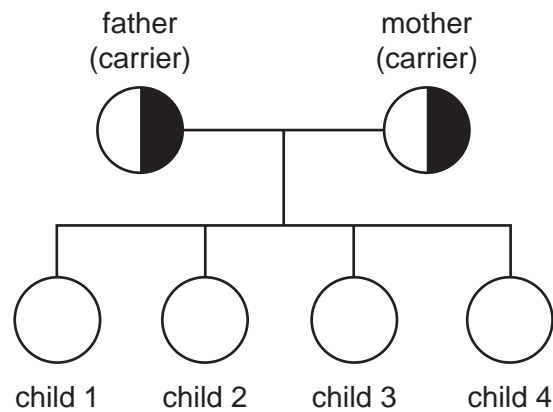

- A** 25% **B** 50% **C** 75% **D** 100%

11 The diagram represents part of a nervous system.

Where would effector cells be found?

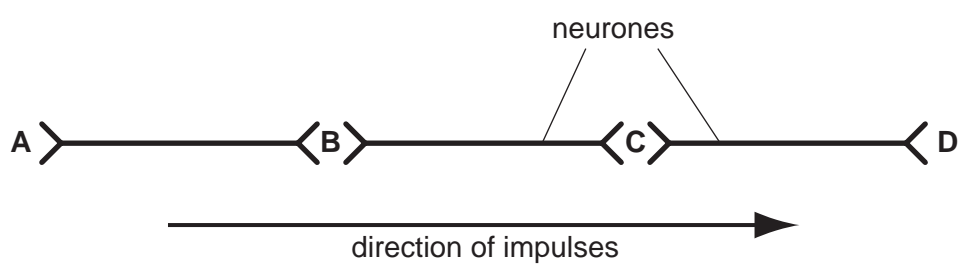

12 In deciding if children should be vaccinated against a disease, which should be considered?

- 1 the chance of getting infected if not vaccinated
- 2 the chance of serious or irreversible harm occurring if not vaccinated
- 3 the various degrees of side effects of the vaccine on different individuals

A 1 only B 1 and 2 only C 1, 2 and 3 D 2 and 3 only

13 The family pedigree tree shows the inheritance of the ability to smell certain flowers called freesias. The allele for the ability to smell freesias is dominant.

Which individual must be **incorrectly** marked?

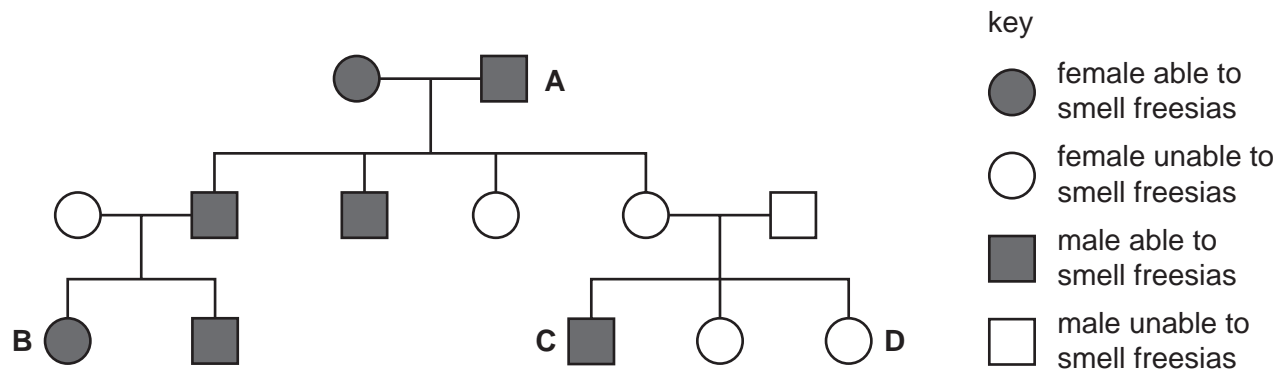

14 The diagram shows a new species of snail being formed.



Which process is occurring during step X?

- A mutation
- B natural selection
- C reproduction
- D variation

15 Which is a harmful chemical produced by mould that can contaminate crops during storage?

- A aflatoxin in nuts and cereals
- B antioxidants in barley
- C gluten in wheat
- D hydrocyanic acid in uncooked cassava

16 What is needed in the diet of a person working hard in a hot climate?

	extra water	high energy intake	protein
A	✓	✓	✓
B	✓	✓	✗
C	✓	✗	✓
D	✗	✓	✓

key

✓ = needed

✗ = not needed

17 Which substance contains nitrogen?

- A amino acids
- B cellulose
- C starch
- D sugar

18 Which pie chart shows the proportion of oxygen in air?

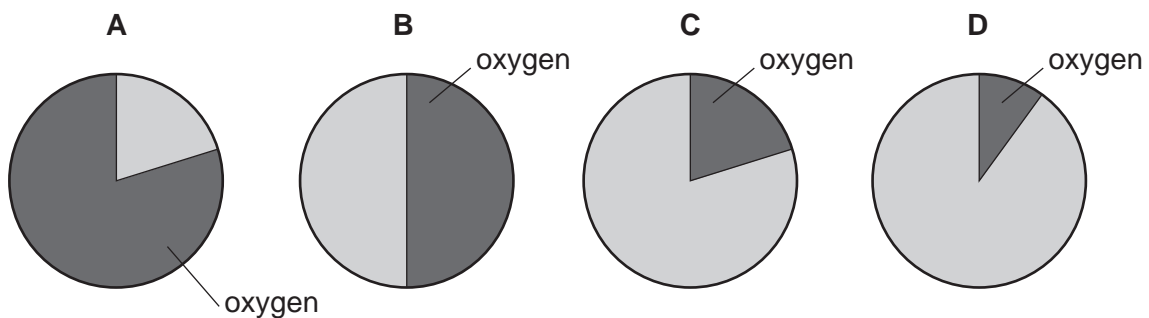

19 Propane, C_3H_8 , combusts readily in air.

How many molecules of water would be formed from the combustion of one molecule of propane?

- A 2
- B 3
- C 4
- D 5

20 The diagram shows a drink of water containing ice cubes

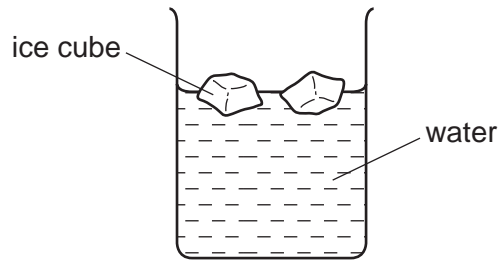

The density of water is 1.0g/cm^3 .

Which is a likely value for the density of ice?

- A 0.5g/cm^3 B 0.9g/cm^3 C 1.0g/cm^3 D 1.2g/cm^3

21 Which diagram shows the monomer used in the manufacture of PVC?

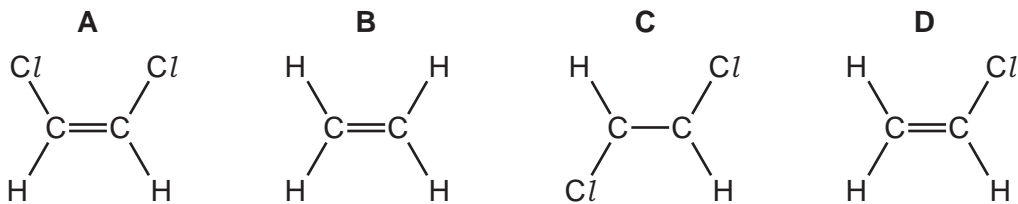

22 The diagram shows the nitrogen cycle.

Which process is represented by denitrifying bacteria?

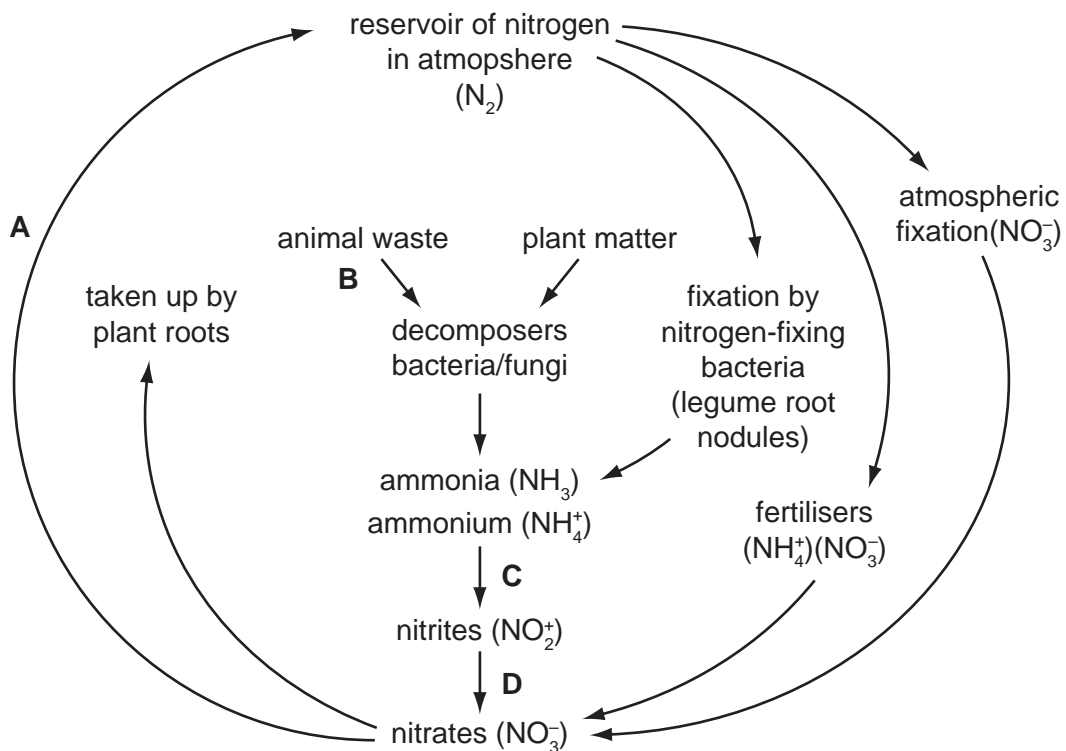

23 The atmospheric pollution caused by power stations which burn fossil fuels can be reduced by:

- 1 fitting a catalytic converter to convert carbon monoxide to carbon dioxide
- 2 reducing the use of air conditioning to use less electricity
- 3 removing sulfur from natural gas and fuel oil
- 4 removing particulates from the gases

Which is correct?

- A** 1, 2 and 3 **B** 1, 2 and 4 **C** 1, 3 and 4 **D** 2, 3 and 4

24 Two molecules of oxygen and one molecule of methane react when methane burns in air.

The diagram shows the molecules that react.



Which diagram shows the correct arrangement of the atoms after the reaction?

- A**
- B**
- C**
- D**

25 Which factor is **not** a key feature of a life cycle assessment for a product?

- A** environmental impact of disposing of the product
- B** environmental impact of using the product
- C** production costs
- D** requirement for energy input

26 A polymer is modified to increase its melting point.

Which polymer shown below would have the highest melting point?

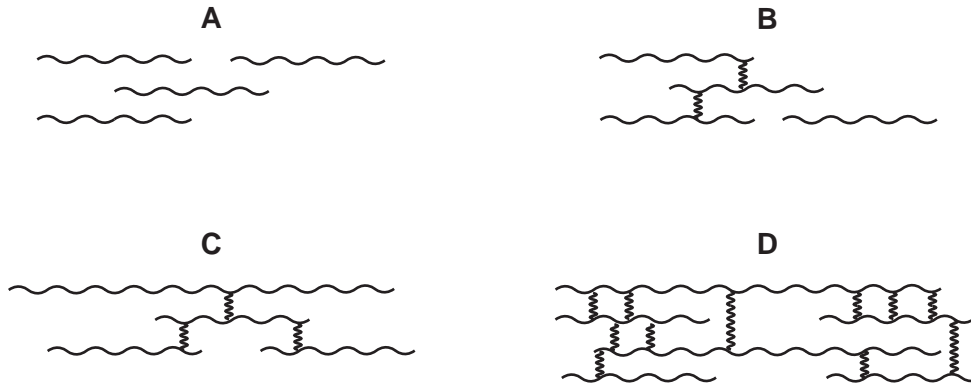

27 The diagram shows where carbon dioxide and oxygen concentrations were measured in a forest, and a graph of the results.

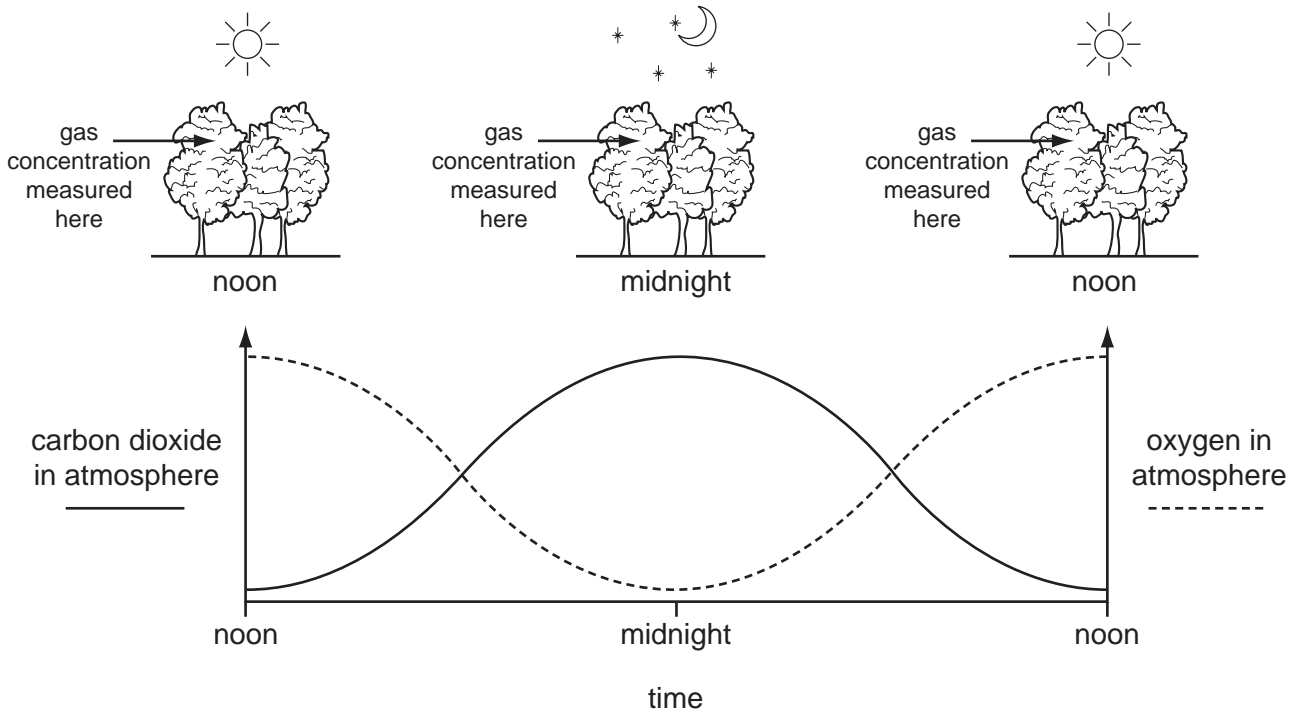

Which statement correctly explains the shape of the graph?

- A During the day photosynthesis removes carbon dioxide from the atmosphere and adds oxygen.
- B During the day respiration removes carbon dioxide from the atmosphere and adds oxygen.
- C During the night photosynthesis adds carbon dioxide to the atmosphere and removes oxygen.
- D During the night respiration removes carbon dioxide from the atmosphere and adds oxygen.

- 28 The diagram shows a Sankey diagram for the production of electricity in a nuclear power station. Which arrow represents the electrical energy produced?

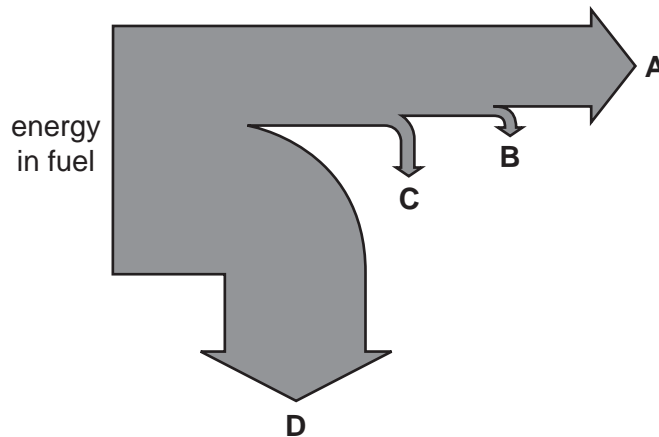

- 29 Which shows the forms of radiation in increasing energy per photon?
- A gamma rays → radio waves → microwaves → infra-red → red light → violet → ultraviolet → X-rays
- B radio waves → microwaves → infra-red → red light → violet → ultraviolet → X-rays → gamma rays
- C radio waves → infra-red → red light → violet → microwaves → ultraviolet → X-rays → gamma rays
- D X-rays → gamma rays → radio waves → microwaves → infra-red → red light → violet → ultraviolet
- 30 In an investigation into atmospheric pollution by a coal fired power station the sulfur dioxide concentration of the air was measured in parts per million (ppm).

sample	day 1	day 2	day 3	day 4
1	101	113	91	82
2	99	114	99	84
3	91	108	87	84
4	102	116	87	76
5	78	112	95	83
6	110	115	92	82
7	109	109	95	87
8	99	113	90	79
9	103	110	94	88
10	100	117	89	85

One of the measurements was discarded as an error.

On which day was this measurement made?

- A day 1 B day 2 C day 3 D day 4

- 31 CT scans use several beams of x-rays. When a patient is being scanned they are receiving ionising radiation.

Which person would be most at risk from receiving an x-ray?

- A a five year old child
B a thirty year old man
C a thirty year old pregnant woman
D a sixty year old woman
- 32 In the Atlantic Ocean the sea floor is spreading.
- By how much is it spreading every year?
- A 1 cm B 10 cm C 1 m D 10 m
- 33 The table lists electromagnetic radiation and their approximate range of frequencies.

electromagnetic radiation	range of frequencies (Hz)
gamma rays	10^{22} to 10^{19}
x-rays	10^{21} to 10^{18}
ultraviolet	10^{18} to 10^{15}
visible	10^{15} to 10^{14}
infra-red	10^{14} to 10^{12}
microwaves	10^{12} to 10^9
radio waves	10^9 to 10^3

Which range of frequencies include ionising radiation?

- A 10^3 to 10^9
B 10^9 to 10^{12}
C 10^{12} to 10^{15}
D 10^{15} to 10^{22}

34 The graph shows the decay curve for a radioactive source.

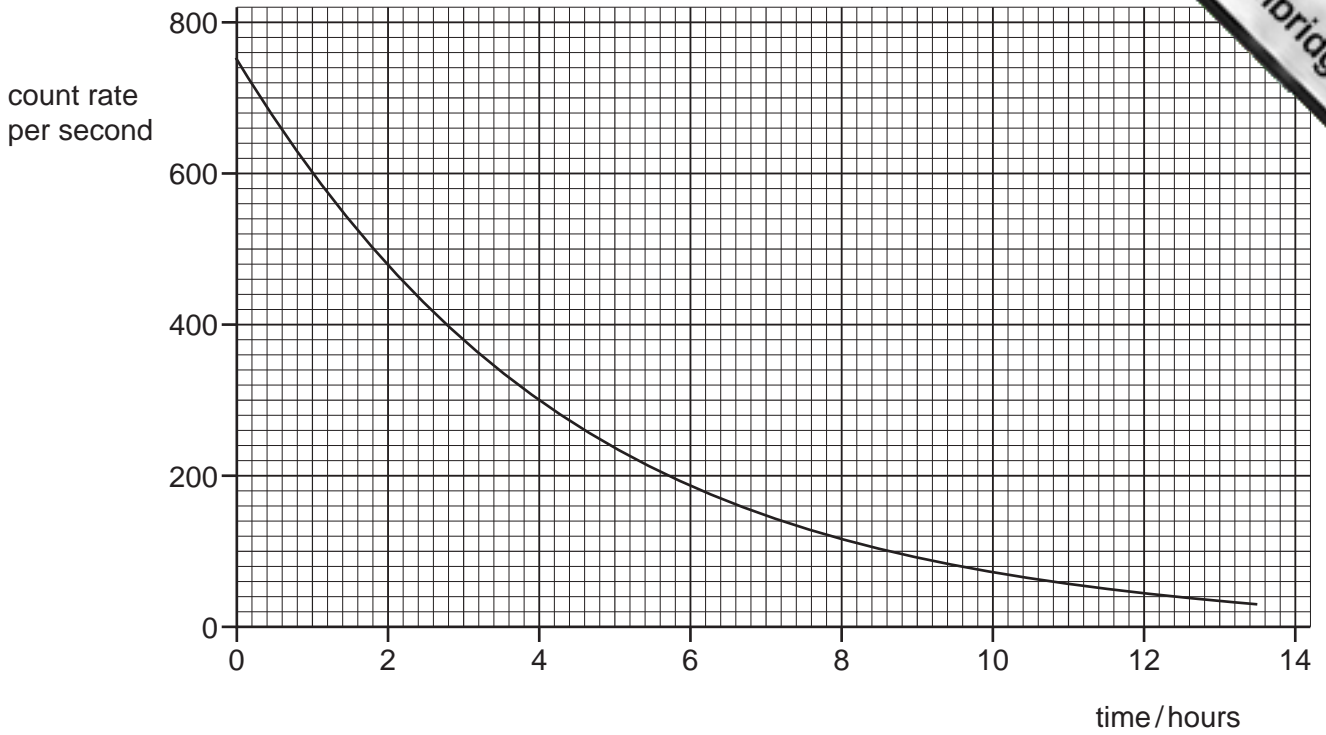

What is the half-life of the source?

- A** 2.0 hours **B** 2.5 hours **C** 3.0 hours **D** 3.5 hours

35 The diagram shows the structure of the Earth.

Which is the mantle?

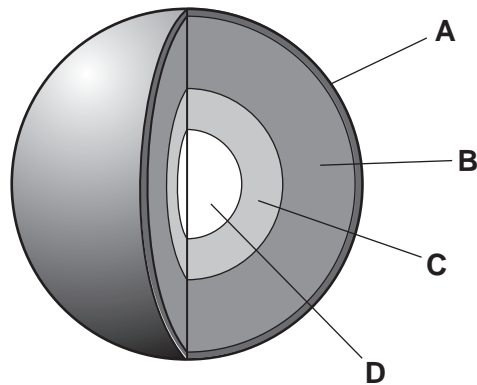

36 What are the correct descriptions of the motion and size of a comet?

	motion	size
A	orbits around the Earth	larger than the Earth
B	orbits around the Earth	smaller than the Earth
C	orbits around the Sun	larger than the Earth
D	orbits around the Sun	smaller than the Earth

37 The diagram shows a person looking at the light from a galaxy.

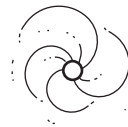

spiral galaxy

The light has taken1..... years to get to the eye of the person. This is because the galaxy is very2.....

Which words correctly complete gaps 1 and 2?

	1	2
A	ten	close
B	one thousand	distant
C	two million	distant
D	one billion	close

38 Wegener suggested the theory of continental drift. This was rejected by the geologists of his time.

Which reasons caused Wegener's theory to be rejected?

- 1 continents fit together in a geometric pattern
- 2 matching fossils can be found in different continents
- 3 mountain chains in separate continents match up
- 4 Wegener was an outsider in the community of geologists

- A** 1 only
B 1, 2 and 4
C 2 and 4 only
D 4 only

39 The graph shows some data on thyroid cancer.

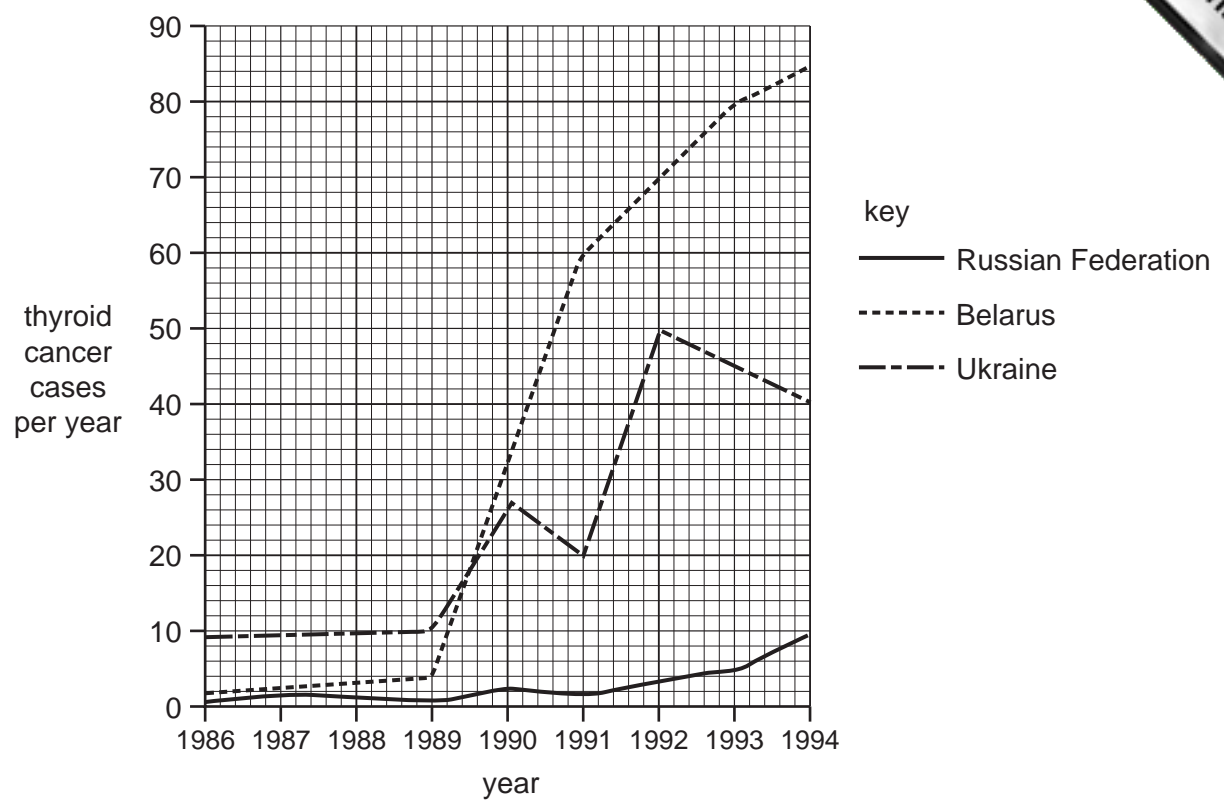

During which year was the number of thyroid cancer cases per year in Belarus three times greater than that in the Ukraine?

- A 1987
- B 1989
- C 1991
- D 1993

40 In a smoke detector a radioactive material and detector are set up as shown below.

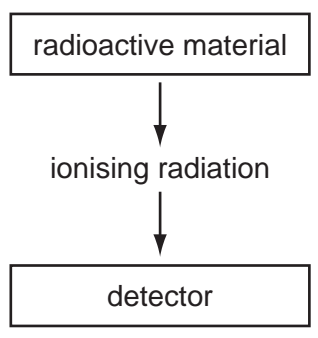

Which material would be suitable as the radioactive material in a smoke detector?

	half-life	type of ionising radiation
A	a few hours	beta
B	a few hours	alpha
C	tens of years	alpha
D	tens of years	gamma

