

Write your name here

Surname

Other names

**Pearson Edexcel
International GCSE**

Centre Number

| | | | | |
|--|--|--|--|--|
| | | | | |
|--|--|--|--|--|

Candidate Number

| | | | |
|--|--|--|--|
| | | | |
|--|--|--|--|

Mathematics A
Paper 4H**Higher Tier**Thursday 7 June 2018 – Morning
Time: 2 hours

Paper Reference

4MA0/4H**You must have:**

Ruler graduated in centimetres and millimetres, protractor, compasses, pen, HB pencil, eraser, calculator. Tracing paper may be used.

Total Marks

Instructions

- Use **black** ink or ball-point pen.
- **Fill in the boxes** at the top of this page with your name, centre number and candidate number.
- Answer **all** questions.
- Without sufficient working, correct answers may be awarded no marks.
- Answer the questions in the spaces provided
– *there may be more space than you need.*
- **Calculators may be used.**
- You must **NOT** write anything on the formulae page.
Anything you write on the formulae page will gain NO credit.

Information

- The total mark for this paper is 100.
- The marks for **each** question are shown in brackets
– *use this as a guide as to how much time to spend on each question.*

Advice

- Read each question carefully before you start to answer it.
- Check your answers if you have time at the end.

Turn over ►

P53339A

©2018 Pearson Education Ltd.

1/1/1



Pearson

**International GCSE MATHEMATICS
FORMULAE SHEET – HIGHER TIER**

Pythagoras' Theorem

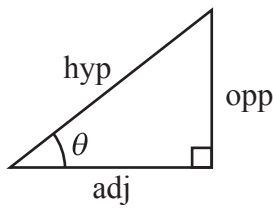
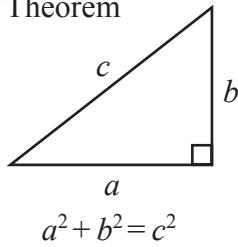

Volume of cone = $\frac{1}{3} \pi r^2 h$

Curved surface area of cone = $\pi r l$

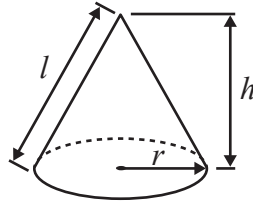

Volume of sphere = $\frac{4}{3} \pi r^3$

Surface area of sphere = $4\pi r^2$

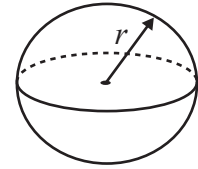

adj = hyp \times cos θ
opp = hyp \times sin θ
opp = adj \times tan θ

or $\sin \theta = \frac{\text{opp}}{\text{hyp}}$

$\cos \theta = \frac{\text{adj}}{\text{hyp}}$

$\tan \theta = \frac{\text{opp}}{\text{adj}}$

In any triangle ABC

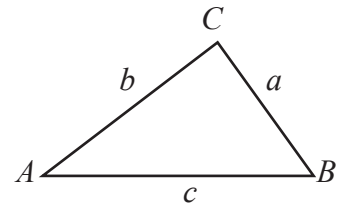

Sine rule: $\frac{a}{\sin A} = \frac{b}{\sin B} = \frac{c}{\sin C}$

Cosine rule: $a^2 = b^2 + c^2 - 2bc \cos A$

Area of triangle = $\frac{1}{2} ab \sin C$

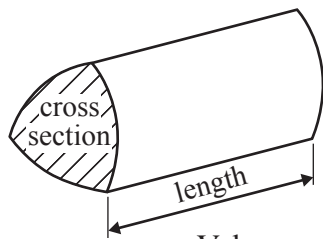

Volume of prism = area of cross section \times length

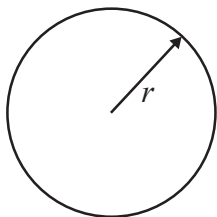

Circumference of circle = $2\pi r$

Area of circle = πr^2

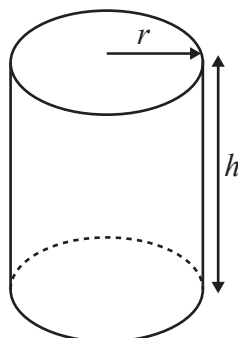

Volume of cylinder = $\pi r^2 h$

Curved surface area of cylinder = $2\pi r h$

Area of a trapezium = $\frac{1}{2}(a + b)h$

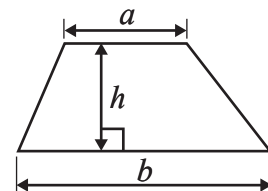

The Quadratic Equation

The solutions of $ax^2 + bx + c = 0$, where $a \neq 0$, are given by

$$x = \frac{-b \pm \sqrt{b^2 - 4ac}}{2a}$$

DO NOT WRITE IN THIS AREA

DO NOT WRITE IN THIS AREA

DO NOT WRITE IN THIS AREA



DO NOT WRITE IN THIS AREA

DO NOT WRITE IN THIS AREA

DO NOT WRITE IN THIS AREA

Answer ALL TWENTY questions.

Write your answers in the spaces provided.

You must write down all the stages in your working.

- 1** Herminia has a swimming pool in her garden.
The pool is empty.
The pool is in the shape of a cuboid that is 12 m long by 8 m wide.
She wants to fill the pool with water to a depth of 1.8 m.

Each hour, 3000 litres of water flows into the pool.
 $1 \text{ m}^3 = 1000 \text{ litres}$

How long will it take to fill the pool to a depth of 1.8 m?
Give your answer correct to the nearest hour.

..... hours

(Total for Question 1 is 4 marks)



2 The area of land on a farm is 120 hectares.

The farmer grows crops on $\frac{7}{8}$ of the land.

On $\frac{2}{3}$ of the land used to grow crops, the farmer grows wheat.

(a) Work out the area of the land on the farm used to grow wheat.

..... hectares
(3)

Last year, the farmer made 31 500 euros from selling his wheat.
His total income was 42 000 euros.

(b) Write 31 500 as a percentage of 42 000

..... %
(2)



Here is a diagram of one field on the farm.

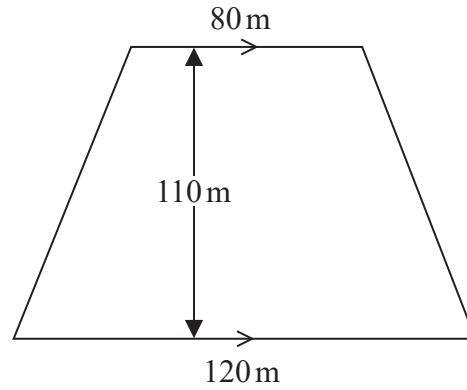

Diagram **NOT**
accurately drawn

The field is in the shape of a trapezium.
The lengths of the parallel sides are 80 m and 120 m.
The distance between the parallel sides is 110 m.

- (c) Work out the area of this field.
Give your answer in m^2

..... m^2
(2)

(Total for Question 2 is 7 marks)



- 3 A teacher asked a group of students how many flights they had each taken in the last year. The table gives information about their answers.

| Number of flights | Number of students |
|-------------------|--------------------|
| 0 | 12 |
| 1 | 3 |
| 2 | 9 |
| 3 | 4 |
| 4 | 14 |
| 5 | 2 |
| 6 | 6 |

- (a) Calculate the mean number of flights.

.....
(3)

The teacher chooses at random a student from the group.

- (b) Find the probability that this student had taken exactly 2 flights.

.....
(1)

(Total for Question 3 is 4 marks)

DO NOT WRITE IN THIS AREA

DO NOT WRITE IN THIS AREA

DO NOT WRITE IN THIS AREA



4

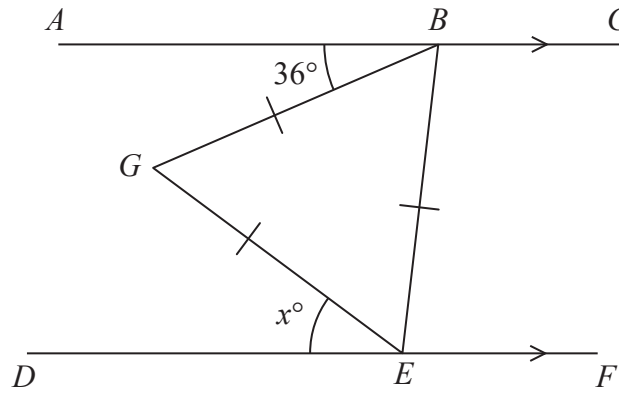

Diagram **NOT**
accurately drawn

ABC and DEF are parallel lines.
 BGE is an equilateral triangle.

Angle $ABG = 36^\circ$

Angle $DEG = x^\circ$

Work out the value of x .

Give reasons for your answer.

.....
(Total for Question 4 is 4 marks)



- 5 Jess makes salad dressing by mixing lemon juice and olive oil in the ratio 2 : 5 by volume. She uses 0.5 litres of lemon juice.

(a) Work out how much olive oil she uses to make the salad dressing.

.....litres
(2)

Tiesto wants to make 630 millilitres of the salad dressing. He mixes lemon juice and olive oil in the ratio 2 : 5 by volume.

(b) Work out how much olive oil he uses to make the salad dressing.

.....millilitres
(2)

Salad dressing is made by mixing lemon juice and olive oil in the ratio 2 : 5 by volume. The cost of lemon juice is \$13.50 per litre. The cost of olive oil is \$18 per litre.

(c) Work out the ratio

cost of lemon juice in the salad dressing : cost of olive oil in the salad dressing

Give your ratio in its simplest form.

.....
(3)

(Total for Question 5 is 7 marks)



DO NOT WRITE IN THIS AREA

6 The diagram shows a circle inside a square $ABCD$.

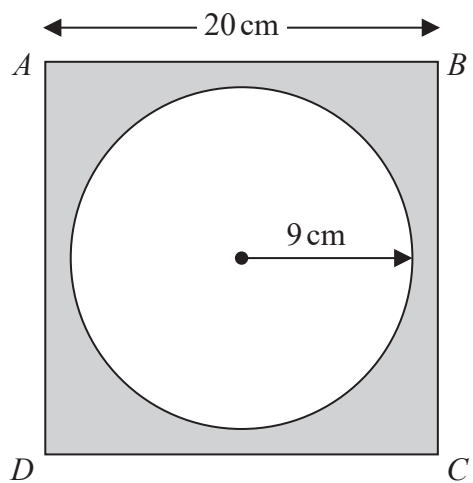

Diagram **NOT** accurately drawn

$AB = 20$ cm.

The radius of the circle is 9 cm.

Work out the area of the shaded region.
Give your answer correct to 1 decimal place.

DO NOT WRITE IN THIS AREA

DO NOT WRITE IN THIS AREA

.....cm²

(Total for Question 6 is 3 marks)



7 (a) Expand $x(2x + 5)$

.....
(1)

(b) Simplify

(i) $y^5 \times y^3$

(ii) $\frac{k^8}{k}$

(iii) $(t^3)^4$

.....
(3)

Pamela, Sophia and Zoe are three friends.

Pamela has x dollars.

Sophia has 4 dollars more than Pamela.

Zoe has three times the number of dollars that Sophia has.

In total, the three friends have T dollars.

(c) Write an expression, in terms of x , for T .

.....
(2)

(Total for Question 7 is 6 marks)

DO NOT WRITE IN THIS AREA

DO NOT WRITE IN THIS AREA

DO NOT WRITE IN THIS AREA



8 (a) Complete the table of values for $y = x^2 - 3x - 1$

| | | | | | | | | |
|-----|----|----|---|----|---|----|---|---|
| x | -2 | -1 | 0 | 1 | 2 | 3 | 4 | 5 |
| y | | 3 | | -3 | | -1 | | 9 |

(2)

(b) On the grid, draw the graph of $y = x^2 - 3x - 1$ for values of x from -2 to 5

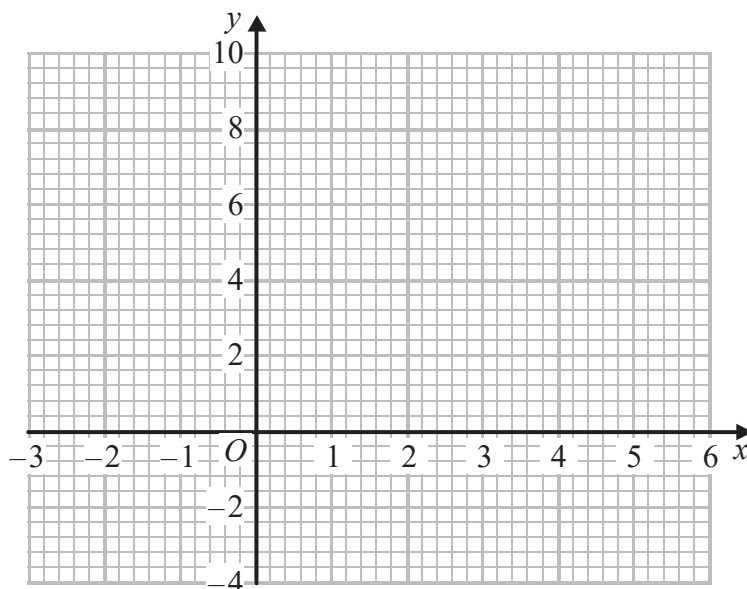

(2)

The point P on the graph of $y = x^2 - 3x - 1$ has coordinates (p, q)

(c) Use the graph to find an estimate for the least possible value of q .

(1)

(Total for Question 8 is 5 marks)



- 9 The diagram shows a right-angled triangle ABC .

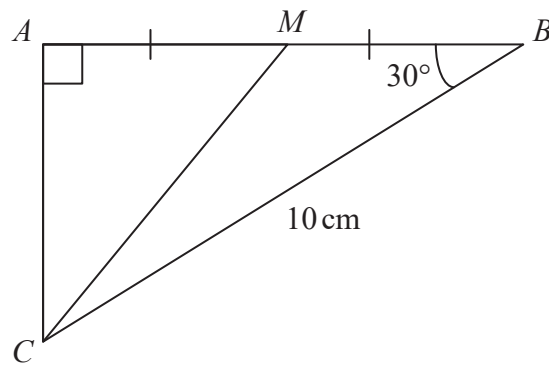

Diagram NOT
accurately drawn

$$BC = 10 \text{ cm.}$$

$$\text{Angle } CAB = 90^\circ$$

$$\text{Angle } ABC = 30^\circ$$

M is the midpoint of AB .

Work out the size of angle AMC .

Give your answer correct to 1 decimal place.

DO NOT WRITE IN THIS AREA

DO NOT WRITE IN THIS AREA

DO NOT WRITE IN THIS AREA

(Total for Question 9 is 5 marks)

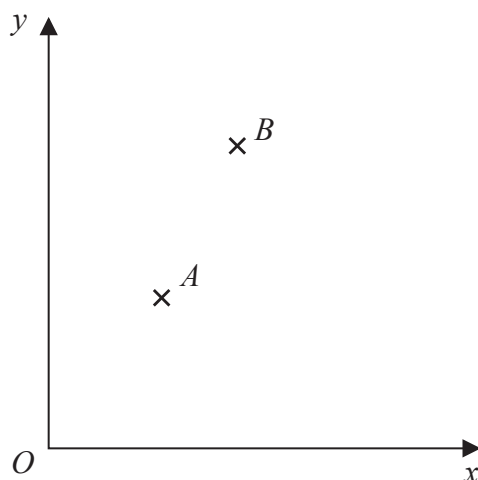

10

Diagram NOT
accurately drawn

A and B are two points such that

$$\vec{OA} = \begin{pmatrix} 3 \\ 4 \end{pmatrix} \text{ and } \vec{OB} = \begin{pmatrix} 5 \\ 8 \end{pmatrix}$$

(a) Find, as a column vector, \vec{AB}

.....
(2)

A and B are two vertices of the trapezium $ABCD$.

AB is parallel to DC .

The length of DC is twice the length of AB .

$$\vec{AD} = \begin{pmatrix} 1 \\ -3 \end{pmatrix}$$

(b) Find, as a column vector, \vec{BC}

.....
(3)

(Total for Question 10 is 5 marks)



11 A company makes small glass cylinders.

Each cylinder has a radius of 1.2 mm
Each cylinder has a volume of 10 mm^3

- (a) Calculate the length of each glass cylinder.
Give your answer correct to 3 significant figures.

.....mm
(3)

The company also makes small glass spheres.

Each sphere has a radius of 0.15 mm
The total surface area of N of these spheres is 1 m^2

- (b) Work out the value of N .
Give your answer correct to 3 significant figures in standard form.

.....
(4)

(Total for Question 11 is 7 marks)

DO NOT WRITE IN THIS AREA

DO NOT WRITE IN THIS AREA

DO NOT WRITE IN THIS AREA



12 Express $\frac{x-3}{2} - \frac{x+4}{3}$ as a single fraction.

Give your answer in its simplest form.

.....
(Total for Question 12 is 3 marks)

13 n is a whole number.

Use algebra to show that $(2n+1)^2 + (n-2)^2$ is always a multiple of 5

.....
(Total for Question 13 is 3 marks)



14 Here is a sketch of the curve with equation $y = x^3 - 12x + 4$

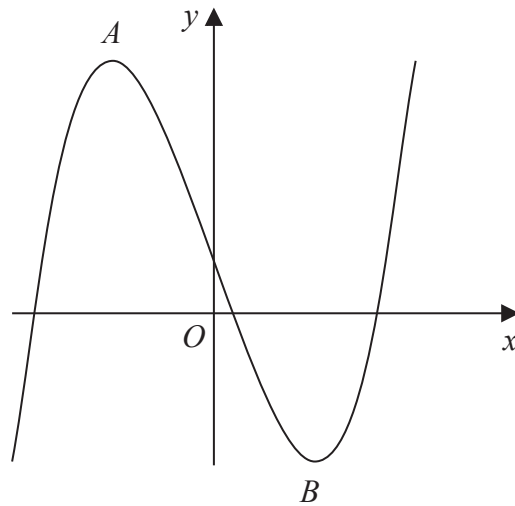

(a) Work out $\frac{dy}{dx}$

$$\frac{dy}{dx} = \dots\dots\dots (2)$$

A and B are the turning points on the curve.

(b) Work out the coordinates of the point A and the coordinates of the point B .

A (.....,))

B (.....,))

(4)



DO NOT WRITE IN THIS AREA

DO NOT WRITE IN THIS AREA

DO NOT WRITE IN THIS AREA

C is the point on the curve with coordinates $(1, -7)$

- (c) Find an equation of the tangent to the curve at C .
Give your answer in the form $y = px + q$

.....
(3)

(Total for Question 14 is 9 marks)



15 Ahmed has two bags of counters, bag P and bag Q.

There are 9 counters in each bag.

There are 6 white counters and 3 black counters in bag P.

There are 4 white counters and 5 black counters in bag Q.

Ahmed takes at random a counter from each bag.

(a) Complete the probability tree diagram.

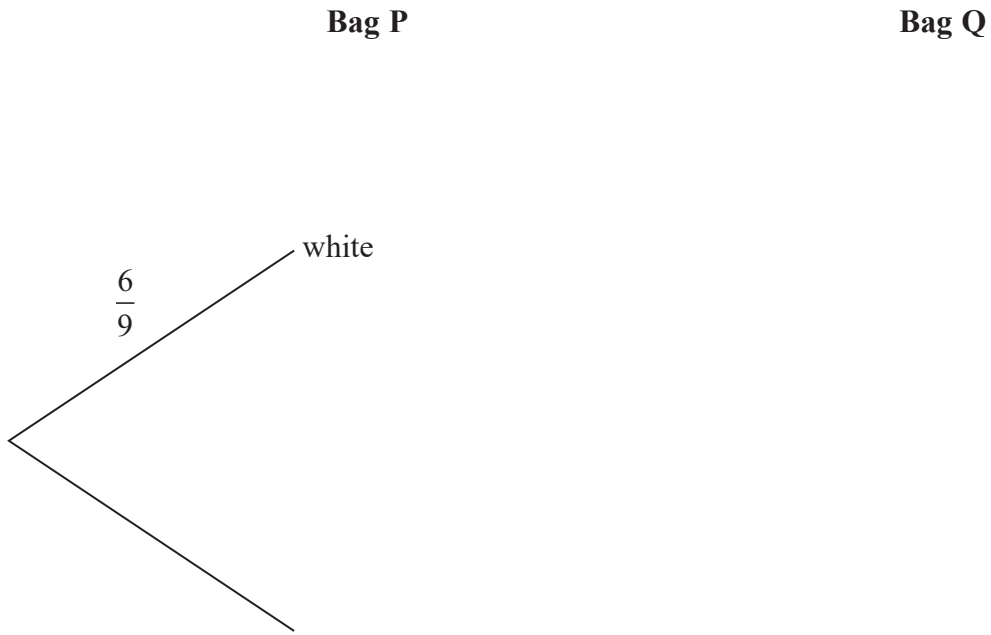

(3)

(b) Calculate the probability that Ahmed takes a white counter from bag P and a black counter from bag Q.

(2)

DO NOT WRITE IN THIS AREA

DO NOT WRITE IN THIS AREA

DO NOT WRITE IN THIS AREA



Bilash has two bags of counters, bag **X** and bag **Y**.

There are 9 counters in each bag.

There are 6 white counters and 3 black counters in bag **X**.

There are 4 white counters and 5 black counters in bag **Y**.

Bilash puts an extra N black counters into bag **Y**.

He is then going to take at random a counter from each bag.

The probability that Bilash will take at random a white counter from bag **X** **and** a black

counter from bag **Y** is $\frac{1}{2}$

(c) Work out the value of N .

.....
(3)

(Total for Question 15 is 8 marks)



16 The velocity, v metres per second, of a particle is proportional to the square root of its kinetic energy, E joules.

$$v = 30 \text{ when } E = 64$$

Find the value of v when $E = 400$

.....
(Total for Question 16 is 4 marks)

DO NOT WRITE IN THIS AREA

DO NOT WRITE IN THIS AREA

DO NOT WRITE IN THIS AREA



17 The incomplete Venn diagram shows a universal set \mathcal{E} and 3 sets A , B and C

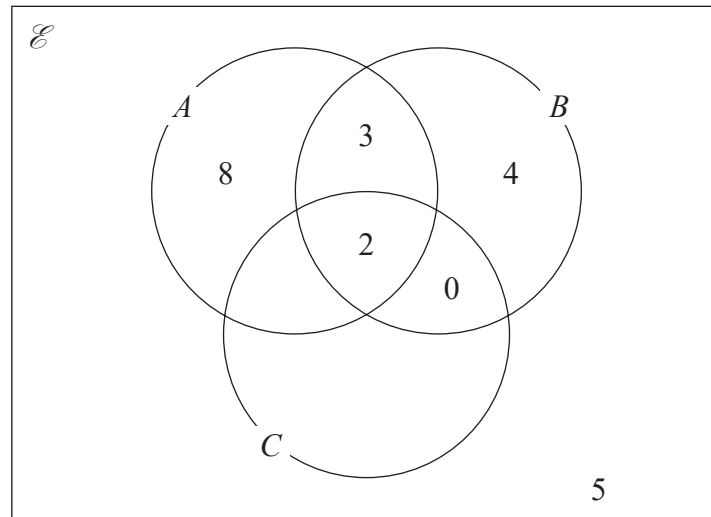

The numbers shown represent **numbers** of elements.

$$n(A \cap C) = 9$$

$$n(A') = 15$$

(a) Complete the Venn diagram.

(2)

(b) Find,

(i) $n(A \cup [B \cap C'])$

(ii) $n([A \cup B'] \cap [A \cup C])$

(2)

(Total for Question 17 is 4 marks)



18

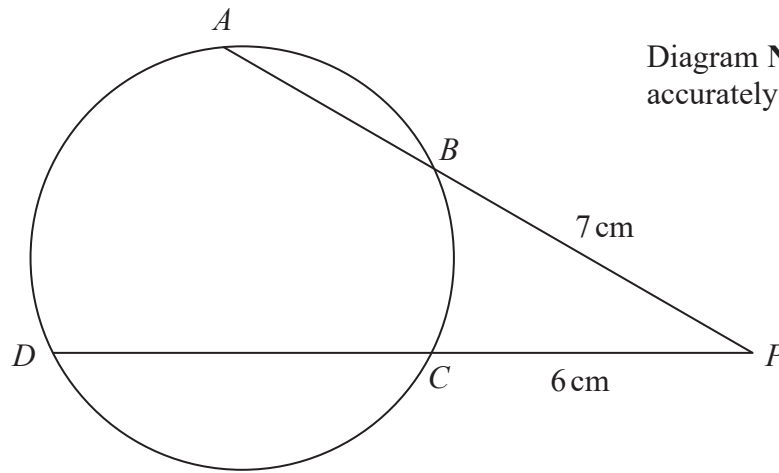

Diagram NOT accurately drawn

DO NOT WRITE IN THIS AREA

DO NOT WRITE IN THIS AREA

DO NOT WRITE IN THIS AREA

A, B, C and D are points on a circle.

PBA and PCD are straight lines.

$PB = 7\text{ cm}$

$PC = 6\text{ cm}$

$DC = 2AB$

Calculate the length of PD .

.....cm

(Total for Question 18 is 4 marks)



DO NOT WRITE IN THIS AREA

19 The histogram gives information about the sizes, in hectares, of some farms in Spain.

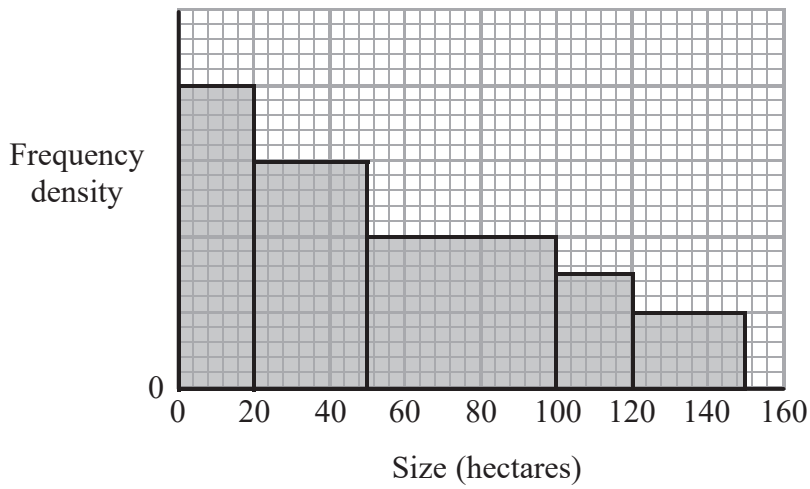

DO NOT WRITE IN THIS AREA

80 of the farms have a size of 20 hectares or less.

20% of the farms with a size of 100 hectares or less grow wheat.

$\frac{3}{4}$ of the farms with a size of more than 100 hectares grow wheat.

Work out the total number of these farms that grow wheat.

DO NOT WRITE IN THIS AREA

(Total for Question 19 is 5 marks)



20 Given that $\frac{12 \times (\sqrt{8})^{2y+2}}{6 \times 4^{2y+1}}$ can be written in the form 2^p ,

find an expression for p in terms of y .

$p = \dots\dots\dots$

(Total for Question 20 is 3 marks)

TOTAL FOR PAPER IS 100 MARKS

DO NOT WRITE IN THIS AREA

DO NOT WRITE IN THIS AREA

DO NOT WRITE IN THIS AREA

