

Please check the examination details below before entering your candidate information

Candidate surname

Other names

**Pearson Edexcel**  
**International GCSE**

Centre Number

--	--	--	--	--

Candidate Number

--	--	--	--

**Tuesday 15 January 2019**

Morning (Time: 2 hours)

Paper Reference **4MA0/4HR**

**Mathematics A**

**Paper 4HR**  
**Higher Tier**

**You must have:**

Ruler graduated in centimetres and millimetres, protractor, compasses, pen, HB pencil, eraser, calculator. Tracing paper may be used.

Total Marks

### Instructions

- Use **black** ink or ball-point pen.
- **Fill in the boxes** at the top of this page with your name, centre number and candidate number.
- Answer **all** questions.
- Without sufficient working, correct answers may be awarded no marks.
- Answer the questions in the spaces provided  
– *there may be more space than you need.*
- **Calculators may be used.**
- You must **NOT** write anything on the formulae page.  
Anything you write on the formulae page will gain **NO** credit.

### Information

- The total mark for this paper is 100.
- The marks for **each** question are shown in brackets  
– *use this as a guide as to how much time to spend on each question.*

### Advice

- Read each question carefully before you start to answer it.
- Check your answers if you have time at the end.

Turn over ►

P55943A

©2019 Pearson Education Ltd.

5/3/17



  
**Pearson**

**FORMULAE SHEET – HIGHER TIER**

Pythagoras' Theorem

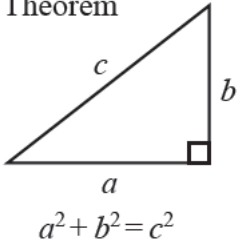

Volume of cone =  $\frac{1}{3} \pi r^2 h$

Curved surface area of cone =  $\pi r l$

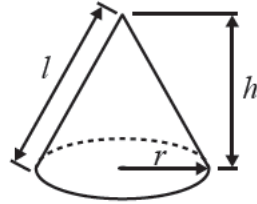

Volume of sphere =  $\frac{4}{3} \pi r^3$

Surface area of sphere =  $4\pi r^2$

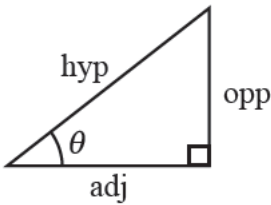
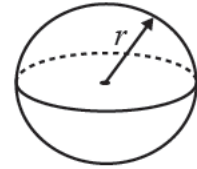

adj = hyp  $\times$  cos  $\theta$   
opp = hyp  $\times$  sin  $\theta$   
opp = adj  $\times$  tan  $\theta$

or  $\sin \theta = \frac{\text{opp}}{\text{hyp}}$

$\cos \theta = \frac{\text{adj}}{\text{hyp}}$

$\tan \theta = \frac{\text{opp}}{\text{adj}}$

In any triangle ABC

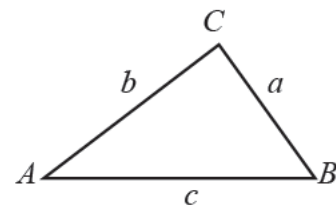

Sine rule:  $\frac{a}{\sin A} = \frac{b}{\sin B} = \frac{c}{\sin C}$

Cosine rule:  $a^2 = b^2 + c^2 - 2bc \cos A$

Area of triangle =  $\frac{1}{2} ab \sin C$

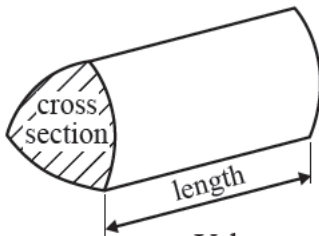

Volume of prism = area of cross section  $\times$  length

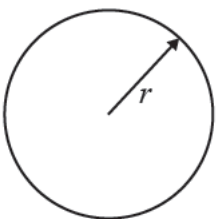

Circumference of circle =  $2\pi r$

Area of circle =  $\pi r^2$

Area of a trapezium =  $\frac{1}{2}(a + b)h$

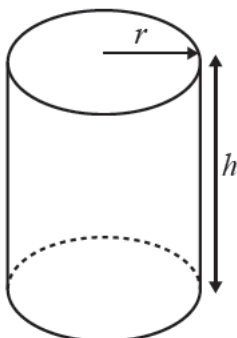
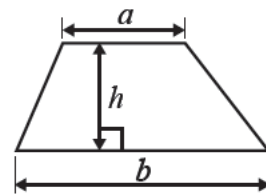

Volume of cylinder =  $\pi r^2 h$

Curved surface area of cylinder =  $2\pi r h$

The Quadratic Equation

The solutions of  $ax^2 + bx + c = 0$ , where  $a \neq 0$ , are given by

$$x = \frac{-b \pm \sqrt{b^2 - 4ac}}{2a}$$

DO NOT WRITE IN THIS AREA

DO NOT WRITE IN THIS AREA

DO NOT WRITE IN THIS AREA



Answer ALL TWENTY TWO questions.

Write your answers in the spaces provided.

You must write down all the stages in your working.

- 1 Yulia normally lives in Russia.  
She buys a car in Cyprus.

The cost of the car is 15 400 euros.

The exchange rate is 1 euro = 63.21 Russian rubles.

- (a) Change 15 400 euros into Russian rubles.

Russian rubles  
(2)

The cost of insuring the car is 240 euros.

- (b) Express 240 as a percentage of 15 400  
Give your answer correct to 2 decimal places.

%

(2)

(Total for Question 1 is 4 marks)



- 2 The diagram shows a square and a circle.

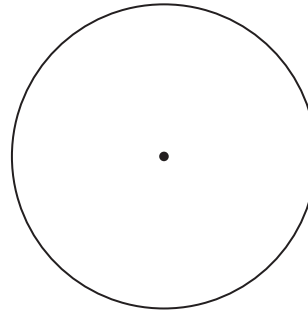
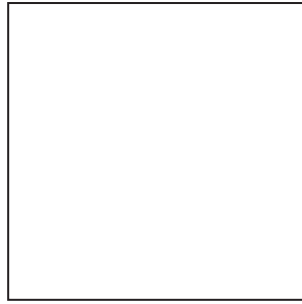

Diagram **NOT**  
accurately drawn

The square has area  $400 \text{ cm}^2$

The diameter of the circle is equal to the length of a side of the square.

Work out the circumference of the circle.

Give your answer correct to 1 decimal place.

cm

(Total for Question 2 is 3 marks)

DO NOT WRITE IN THIS AREA

DO NOT WRITE IN THIS AREA

DO NOT WRITE IN THIS AREA



DO NOT WRITE IN THIS AREA

DO NOT WRITE IN THIS AREA

DO NOT WRITE IN THIS AREA

3 An aeroplane takes 11 hours 40 minutes to fly from London to Mauritius.  
The aeroplane flies a distance of 9720 kilometres.

Work out the average speed of the aeroplane.

Give your answer in kilometres per hour, correct to the nearest whole number.

kilometres per hour

**(Total for Question 3 is 3 marks)**



4 The length of a car is 472 centimetres.

Mikhail makes a scale model of the car using a scale of 1 : 20

(a) Work out the length of the scale model.

centimetres  
(2)

Alis makes a scale model of a bus.

The length of the real bus is 10.8 metres.

The length of the scale model is 60 centimetres.

Alis uses a scale of 1 :  $n$  where  $n$  is a whole number.

(b) Find the value of  $n$ .

$n =$   
(3)

(Total for Question 4 is 5 marks)

DO NOT WRITE IN THIS AREA

DO NOT WRITE IN THIS AREA

DO NOT WRITE IN THIS AREA



- 5 (a) Solve  $5x - 2 = x + 8$   
Show clear algebraic working.

$$x = \quad (3)$$

- (b) Factorise  $3t - 5ty$  (1)

- (c) Simplify  $k^5 \times k$  (1)

- (d) Simplify  $\frac{5}{2h} - \frac{1}{h}$  (2)  
Give your answer as a single fraction in its simplest form.

(Total for Question 5 is 7 marks)



6 Here is a right-angled triangle.

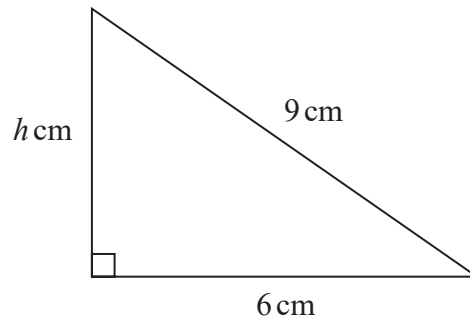

Diagram **NOT**  
accurately drawn

Calculate the value of  $h$ .  
Give your answer correct to 2 decimal places.

$$h =$$

(Total for Question 6 is 3 marks)

7 Show that  $2\frac{1}{4} \times \frac{5}{6} = 1\frac{7}{8}$

(Total for Question 7 is 3 marks)





8 Here is a prism.

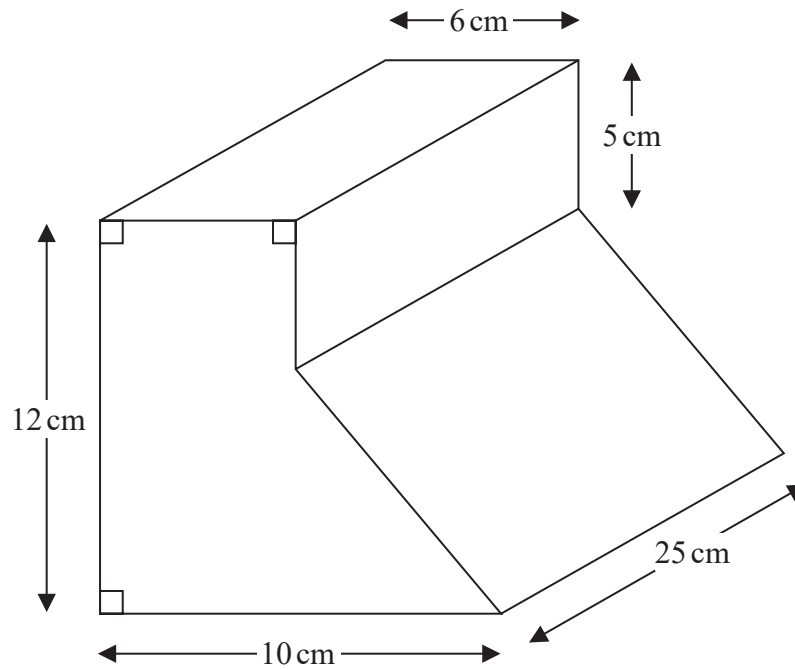

Diagram NOT  
accurately drawn

Work out the volume of this prism.

cm<sup>3</sup>

(Total for Question 8 is 4 marks)



9 Eugenia bought 120 watches at 50 dollars each.

She sold  $\frac{3}{4}$  of the watches at 80 dollars each.

She then sold all the remaining watches at 40 dollars each.

Work out her percentage profit.

%

(Total for Question 9 is 4 marks)

DO NOT WRITE IN THIS AREA

DO NOT WRITE IN THIS AREA

DO NOT WRITE IN THIS AREA



10  $\mathcal{E} = \{1, 2, 3, 4, 5, 6, 7, 8, 9, 10\}$

$$A = \{1, 3, 5, 7, 9\}$$

$$B = \{\text{numbers greater than } 6\}$$

(a) List the members of the set  $A \cup B$

(1)

$$C = \{3, 6, 9\}$$

(b) List the members of the set  $A \cap C$

(1)

$D$  is a set with 4 members.

$$5 \in D \text{ and } B \cap D = \emptyset$$

(c) List the members of one possible set  $D$ .

(2)

(Total for Question 10 is 4 marks)

DO NOT WRITE IN THIS AREA

DO NOT WRITE IN THIS AREA

DO NOT WRITE IN THIS AREA



11 The first four terms of a sequence are

11      21      31      41

(a) Write down an expression, in terms of  $n$ , for the  $n$ th term of the sequence.

(2)

(b) Factorise  $x^2 - 7x + 6$

(2)

(c) Expand and simplify  $(2e - 3f)(3e - 4f)$

(2)

(Total for Question 11 is 6 marks)

DO NOT WRITE IN THIS AREA

DO NOT WRITE IN THIS AREA

DO NOT WRITE IN THIS AREA



12 Mwai plays netball.

In January, she played in 11 netball matches.

Here is the number of goals she scored in each of these matches.

42    20    37    32    32    41    37    40    28    36    36

- (a) Find the interquartile range of the numbers of goals Mwai scored in January.  
Show your working clearly.

(3)

In February, Mwai played in 10 netball matches.

In each of these matches, she scored more than 41 goals.

- (b) Work out the median of the numbers of goals that Mwai scored in the 21 matches in January and February.

(2)

(Total for Question 12 is 5 marks)

DO NOT WRITE IN THIS AREA

DO NOT WRITE IN THIS AREA

DO NOT WRITE IN THIS AREA

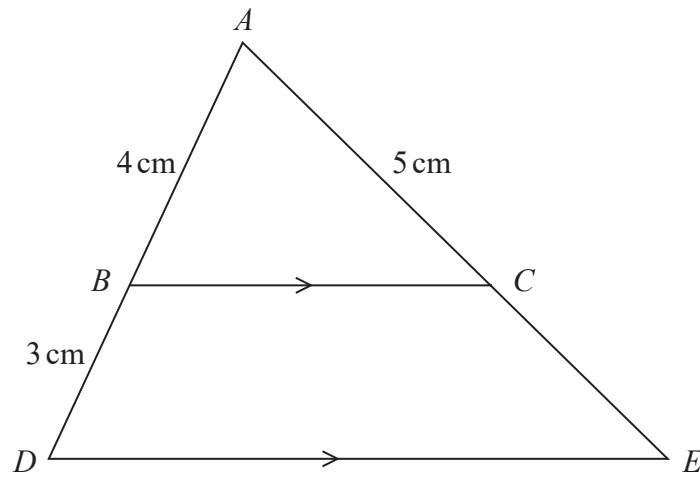

13

Diagram NOT  
accurately drawn

In the diagram  $ABD$  and  $ACE$  are straight lines.  
 $BC$  is parallel to  $DE$ .

(a) Calculate the length of  $CE$ .

(2) cm

The area of triangle  $ABC$  is  $8 \text{ cm}^2$

(b) Work out the area of trapezium  $BCED$ .

(3)  $\text{cm}^2$

(Total for Question 13 is 5 marks)

DO NOT WRITE IN THIS AREA

DO NOT WRITE IN THIS AREA

DO NOT WRITE IN THIS AREA



14 Here is a solid shape S.

The solid shape consists of a cylinder and a hemisphere.

The centre of the circular face of the hemisphere and the centre of the top face of the cylinder are at the same point.

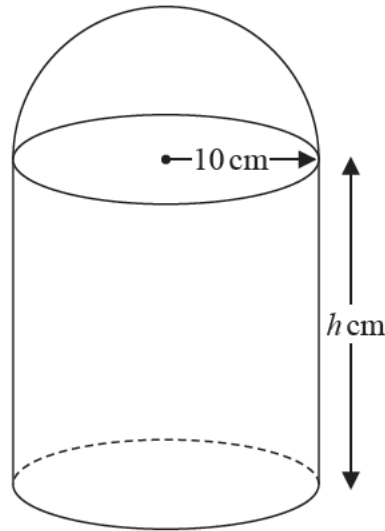

Diagram NOT  
accurately drawn

The radius of the cylinder and the radius of the hemisphere are both 10 cm.  
The height of the cylinder is  $h$  cm.

The total surface area of S is  $1000\pi$  cm<sup>2</sup>

Find the value of  $h$ .

$$h =$$

(Total for Question 14 is 3 marks)



15 Bag A and bag B each contain 10 counters.

There are 7 red counters and 3 green counters in bag A.  
There are 4 red counters and 6 green counters in bag B.

Ahmed takes at random a counter from bag A.  
Bhavana takes at random a counter from bag B.

(a) Complete the probability tree diagram.

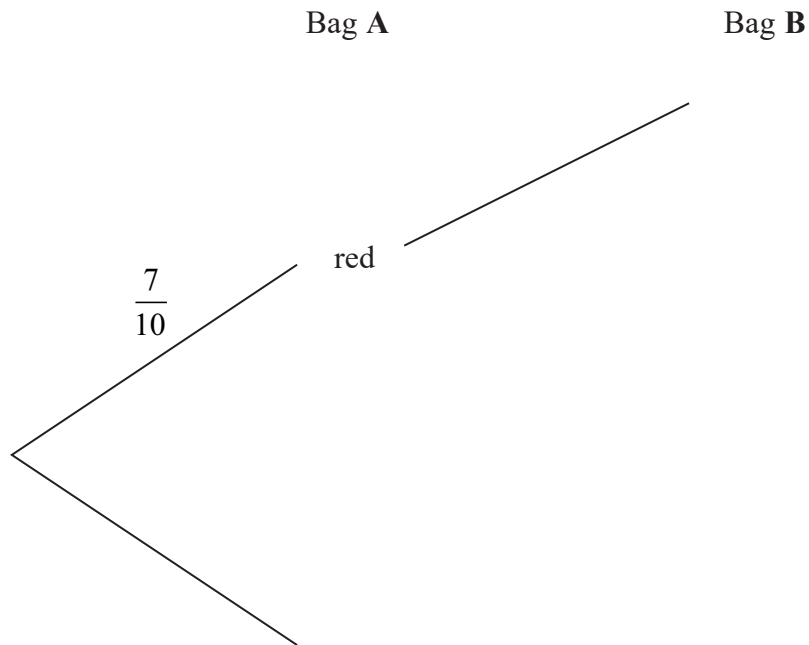

(3)

(b) Calculate the probability that Ahmed takes a red counter and Bhavana takes a green counter.

(2)

DO NOT WRITE IN THIS AREA

DO NOT WRITE IN THIS AREA

DO NOT WRITE IN THIS AREA





(c) Calculate the probability that at least one red counter is taken.

(3)

(Total for Question 15 is 8 marks)

16 Solve the inequality  $2x^2 - 32 < 0$   
Show clear algebraic working.

(Total for Question 16 is 4 marks)



17  $A, B, C$  and  $D$  are points on a circle, centre  $O$ .

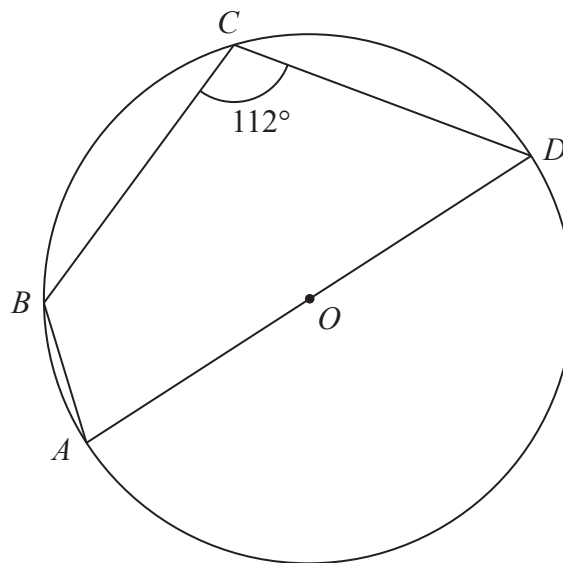

Diagram **NOT**  
accurately drawn

DO NOT WRITE IN THIS AREA

DO NOT WRITE IN THIS AREA

DO NOT WRITE IN THIS AREA

$AOD$  is a diameter of the circle.  
Angle  $BCD = 112^\circ$

Calculate the size of angle  $ADB$ .  
Give a reason for each stage of your working.

(Total for Question 17 is 5 marks)



18 A particle  $P$  moves along a straight line.

$O$  is a fixed point on the line.

The displacement,  $s$  metres, of  $P$  from  $O$  at time  $t$  seconds is given by

$$s = t + \frac{36}{t} + 4 \quad \text{for } t > 1$$

The velocity of  $P$  at time  $t$  seconds is  $v$  m/s.

(a) By differentiation, find an expression for  $v$  in terms of  $t$  for  $t > 1$

$$v = \quad \quad \quad (2)$$

(b) Find the value of  $t$  for which  $v = 0$

$$t = \quad \quad \quad (2)$$

The acceleration of  $P$  at time  $t$  seconds is  $a$  m/s<sup>2</sup>

(c) Find the value of  $a$  when  $t = 2$

$$a = \quad \quad \quad (2)$$

(Total for Question 18 is 6 marks)

DO NOT WRITE IN THIS AREA

DO NOT WRITE IN THIS AREA

DO NOT WRITE IN THIS AREA



19 Solve the simultaneous equations

$$y = 8 - 2x$$

$$x^2 + y^2 = 29$$

Show clear algebraic working.

DO NOT WRITE IN THIS AREA

DO NOT WRITE IN THIS AREA

DO NOT WRITE IN THIS AREA

(Total for Question 19 is 6 marks)



- 20 Find the value of  $n$  such that  $4^n \times 8^{n+1} = 16$   
Show clear algebraic working.

$$n =$$

(Total for Question 20 is 3 marks)

DO NOT WRITE IN THIS AREA

DO NOT WRITE IN THIS AREA

DO NOT WRITE IN THIS AREA



- 21 Mayang collected bamboo plants for an experiment.  
The heights of Mayang's bamboo plants are all between 10 cm and 110 cm.

The incomplete histogram gives some information about the heights,  $h$  cm, of the bamboo plants.

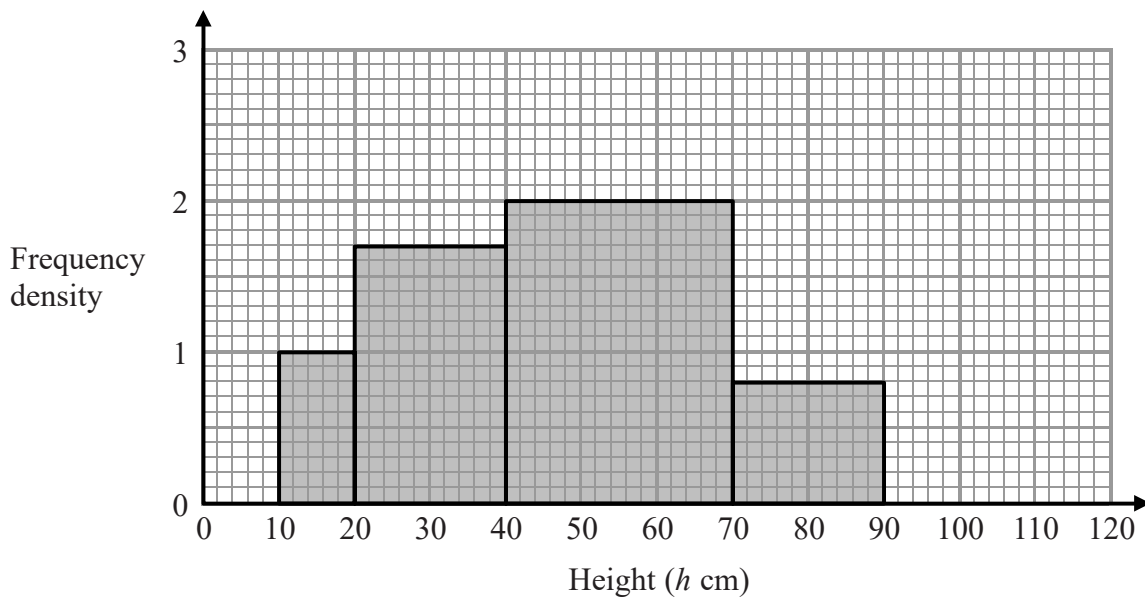

Mayang found that 4% of the bamboo plants had heights in the interval  $90 < h \leq 110$

Use this information to complete the histogram.

(Total for Question 21 is 4 marks)



22  $a = 2x + 1$                        $b = 3x - 2$                        $c = x - 1$

Express  $1 - \frac{a + \frac{1}{b}}{a + \frac{1}{c}}$  in the form  $\frac{1}{px^2 + qx}$  where  $p$  and  $q$  are integers.

DO NOT WRITE IN THIS AREA

DO NOT WRITE IN THIS AREA

DO NOT WRITE IN THIS AREA

---

(Total for Question 22 is 5 marks)

---

TOTAL FOR PAPER IS 100 MARKS



DO NOT WRITE IN THIS AREA

DO NOT WRITE IN THIS AREA

DO NOT WRITE IN THIS AREA

**BLANK PAGE**

**Do NOT write on this page.**

